

MARKER UNIT **IC-EX195**
LDA UNIT **IC-EX202**
CW AUDIO FILTER UNIT **IC-EX203**
TRV UNIT **IC-EX205**
SSB PBT CRYSTAL FILTER **FL-30**
455KHz SSB CRYSTAL FILTER **FL-44**
CW NARROW CRYSTAL FILTER **FL-45**
FOR **IC-730**



TABLE OF CONTENTS

1. DESCRIPTION.....	1
2. PREPARATION.....	3
3. ASSEMBLY PROCEDURE.....	5
3-1 INSTALLATION OF THE IC-EX195 (MARKER UNIT).....	5
3-2 INSTALLATION OF THE IC-EX203 (CW AUDIO FILTER UNIT).....	9
3-3 INSTALLATION OF THE IC-EX202 (LDA UNIT).....	11
3-4 INSTALLATION OF THE IC-EX205 (TRV UNIT).....	17
3-5 INSTALLATION OF THE FL-44 (455KHz SSB CRYSTAL FILTER).....	19
3-6 INSTALLATION OF THE FL-30 (SSB PASS BAND TUNING CRYSTAL FILTER).....	21
3-7 INSTALLATION OF THE FL-45 (CW NARROW CRYSTAL FILTER).....	22
4. SCHEMATIC DIAGRAM.....	23

This instruction manual gives descriptions and installation instructions for the optional units and crystal filters for ICOM's HF transceiver IC-730.

It also provides information you need while using them. Please read all the instructions carefully before installation so you will get maximum performance and full value of the equipment.

1. DESCRIPTION

1 - 1 IC-EX195 (MARKER UNIT)

This unit generates marker signals to calibrate IC-730's operation frequency. The marker generator puts out accurate 100KHz or 25KHz signals on the entire band, and gives easy and accurate frequency calibration.

1 - 2 IC-EX203 (CW AUDIO FILTER UNIT)

This unit is an audio filter which gives 150Hz/6 dB pass-band in the CW operation. This is very effective in reducing interference from near-by signals and increasing SN ratio.

1 - 3 IC-EX202 (LDA UNIT)

This unit puts out the band control voltage to change operating band automatically for external equipment such as a linear amplifier and an antenna tuner.

-1-

1 - 4 IC-EX205 (TRV UNIT)

This unit provides terminals to put out a low level RF signals, and for receiver input and T/R control on the rear panel of IC-730 for a VHF/UHF transverter.

1 - 5 FL-44 (455KHz SSB CRYSTAL FILTER)

This filter is for replacement of the 455KHz mechanical filter installed in the 2nd IF circuit, and has a higher shape factor and provides more selectivity.

1 - 6 FL-30 (SSB PASS BAND TUNING CRYSTAL FILTER)

This filter provides the Pass Band Tuning system which narrows the IF Pass Band continuously up to 1KHz either from upper side or lower side. This is very effective in reducing interference from nearby signals.

1 - 7 FL-45 (CW NARROW CRYSTAL FILTER)

This filter provides a 500Hz/6 dB pass band in the CW operation. When the MODE Switch of IC-730 is set in the "CW-N" position, this filter is selected automatically.

-2-

2. PREPARATION

2-1 TOOLS FOR INSTALLATION

The following tools are needed for the installation of the options.

Tools	IC-EX195	IC-EX203	IC-EX202	IC-EX205	FL-44	FL-30	FL-45
Phillips Screwdriver	○	○	○	○	○	○	○
Screwdriver for 2mm Hex-hole Screw	×	○	○	×	×	×	×
Soldering Iron (20W ~ 40W)	×	×	×	×	○	○	○
Solder (rosin core)	×	×	×	×	○	○	○
De-soldering Braid	×	×	×	×	○	×	×
Diagonal Cutter	×	×	×	×	○	○	○
Long-nose Pliers	×	×	×	×	○	○	○

NOTE: ○ means NEED, × means NOT NEEDED

-3-

2-2 PREPARATION

Before performing any work on the set, make sure that the power cord is unplugged from the receiver.

Remove the top cover by unscrewing the four screws on the top and the two screws at each side, while taking care not to damage the internal speaker and unplug its connector.

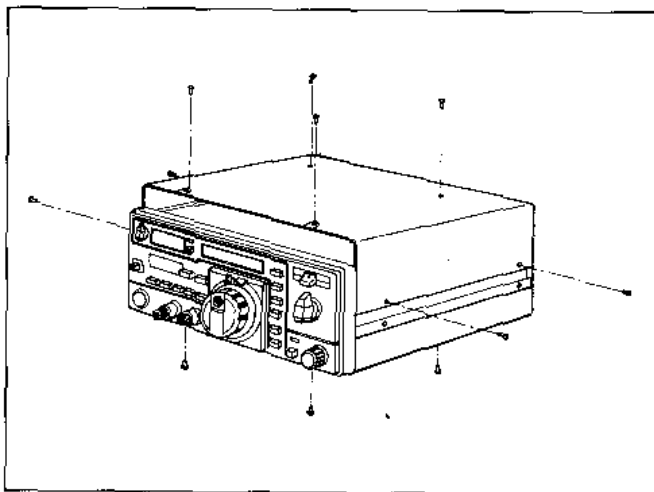

When installing IC-EX202 and/or IC-EX205, also remove the bottom cover by unscrewing the four screws on the bottom.

-4-

3. ASSEMBLY PROCEDURE

3-1 INSTALLATION OF THE IC-EX195 (MARKER UNIT)

3-1-1 PARTS LOCATION

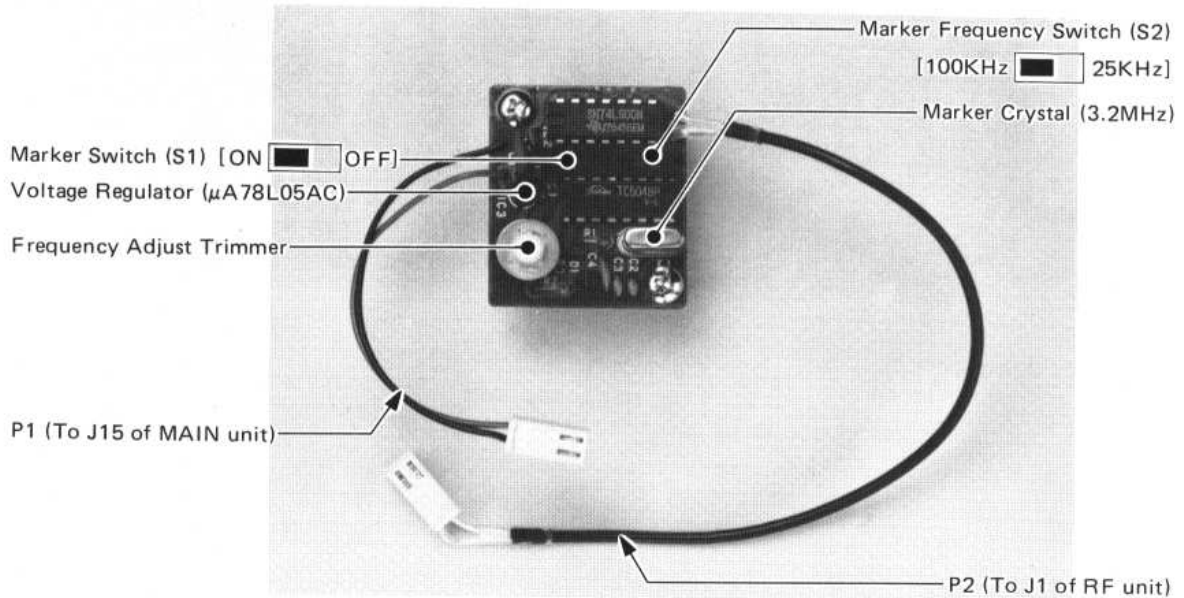

-5-

3-1-2 ASSEMBLY PROCEDURE

- ① Install this unit in the position shown in the photo using the attached screws.

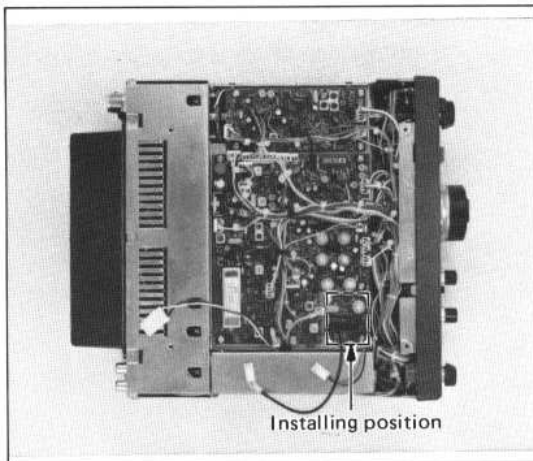

- ② Plug P1 of this unit to J15 of the MAIN unit.

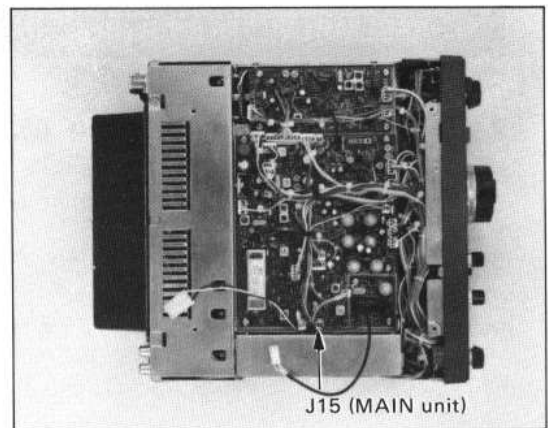

- ③ Plug P2 of this unit to J1 of the RF unit.

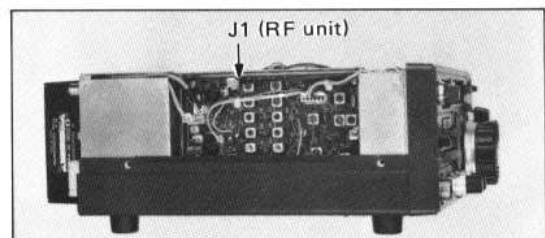

-6-

3 - 1 - 3 CHECKING THE OPERATION

- ① While performing the installation, set the marker switch of the unit to the "OFF" position and the marker frequency switch in the "100KHz" position.
- ② Connect the plug of the internal speaker on the top cover to the original connector, or an external speaker to the external speaker jack on the rear panel.
- ③ Make sure the power switch of your IC-730 is turned OFF. Set the other controls and switches in the receive mode according to the manual of IC-730. Then connect the power plug to the power socket of the IC-730.
- ④ Turn the power switch of the IC-730 ON, and the set operates in the receive mode.
- ⑤ Set the marker switch of this unit to the "ON" position and the marker frequency switch in the "100KHz" position. Then turn the tuning control knob, and you can receive a strong signal on every 100KHz.
- ⑥ Set the marker frequency switch in the "25KHz" position, and you can also receive a strong signal on every 25KHz. These are the complete operations of the unit.
- ⑦ When the operations are performed, unplug the power cord again and replace the speaker connector and covers.

-7-

3 - 1 - 4 CALIBRATION

1. CALIBRATION OF THE MARKER

- ① Set the MODE Switch in the "AM" position and BAND Switch in the "10MHz" position, then turn ON the POWER Switch.
- ② The FREQUENCY DISPLAY will show "10.100.0". Turn the TUNING CONTROL knob to tune to WWV (or other standard frequency station) on 10.000MHz. Set the TUNING RATE Switch in 10Hz steps for fine tuning.
- ③ Turn ON the marker switch on the unit and adjust the FREQUENCY ADJUST trimmer on the unit to make "zero beat" with WWV.
- ④ When you have performed the calibration, turn OFF the marker switch.

2. CALIBRATION OF THE TRANSCEIVER

- ① Set the MODE Switch in the CW position and the TUNING RATE Switch in 100Hz position. Tune to the lower band edge of the band you want to calibrate, as an example, "21.000.0".
- ② Ground the KEY jack on the rear panel so that the CW sidetone becomes audible. (Don't transmit.)
- ③ Turn ON the marker switch, and adjust the FREQUENCY SET control of the set, so that the two tones are of the same pitch (in zero beat).
- ④ The frequency calibration is sufficient on a frequency on the same band, but it is required for each band.

-8-

3-2 INSTALLATION OF THE IC-EX203 (CW AUDIO FILTER UNIT)

3-2-1 PARTS LAYOUT

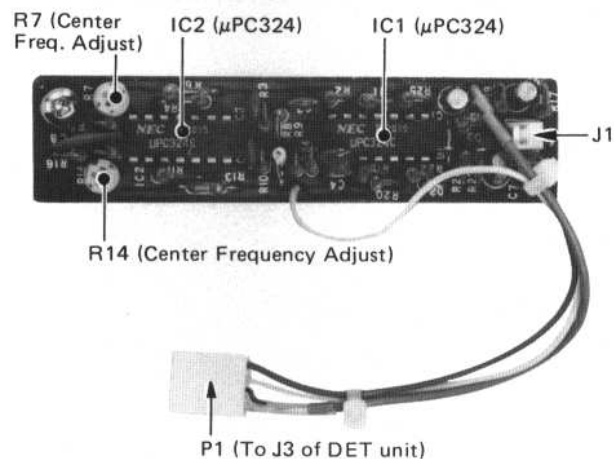

3-2-2 INSTALLATION PROCEDURE

- ① Loosen two retaining screws of the upper sub-chassis, and turn the sub-chassis around hinges on the other end as shown in the photo.

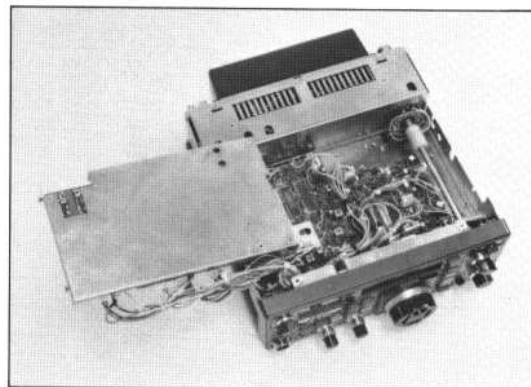

- ② Loosen the front side screw of the shaft coupling sleeve of the band switch and remove the shaft sliding toward front side.

-9-

Install this unit to the position shown in the photo using screws that have been attached.

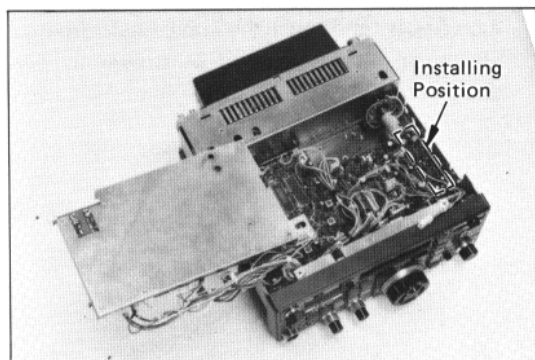

- ③ Replace the shaft and the upper sub-chassis. Unplug P11 inserted to J3 of the DET unit and plug it to J1 of IC-EX203.
- ④ Plug P1 of IC-EX203 to J3 of the DET unit. Tighten the retaining screws of the sub-chassis.

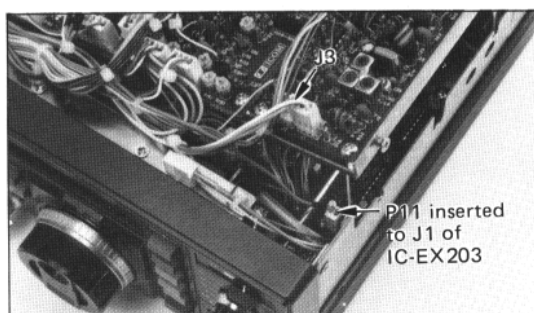
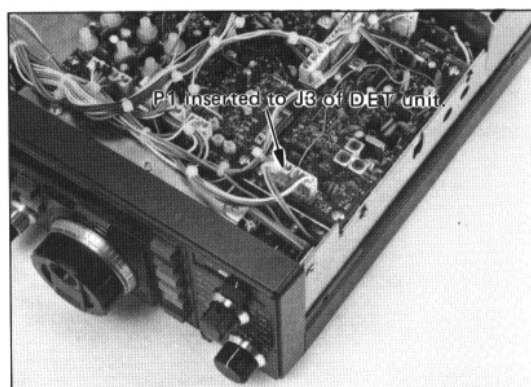

- ⑤ This unit does not require an adjustment, and provides 150Hz/6dB pass band when the set is in the CW mode.

-10-

3-3 INSTALLATION OF THE IC-EX202 (LDA UNIT)

3-3-1 PARTS LAYOUT

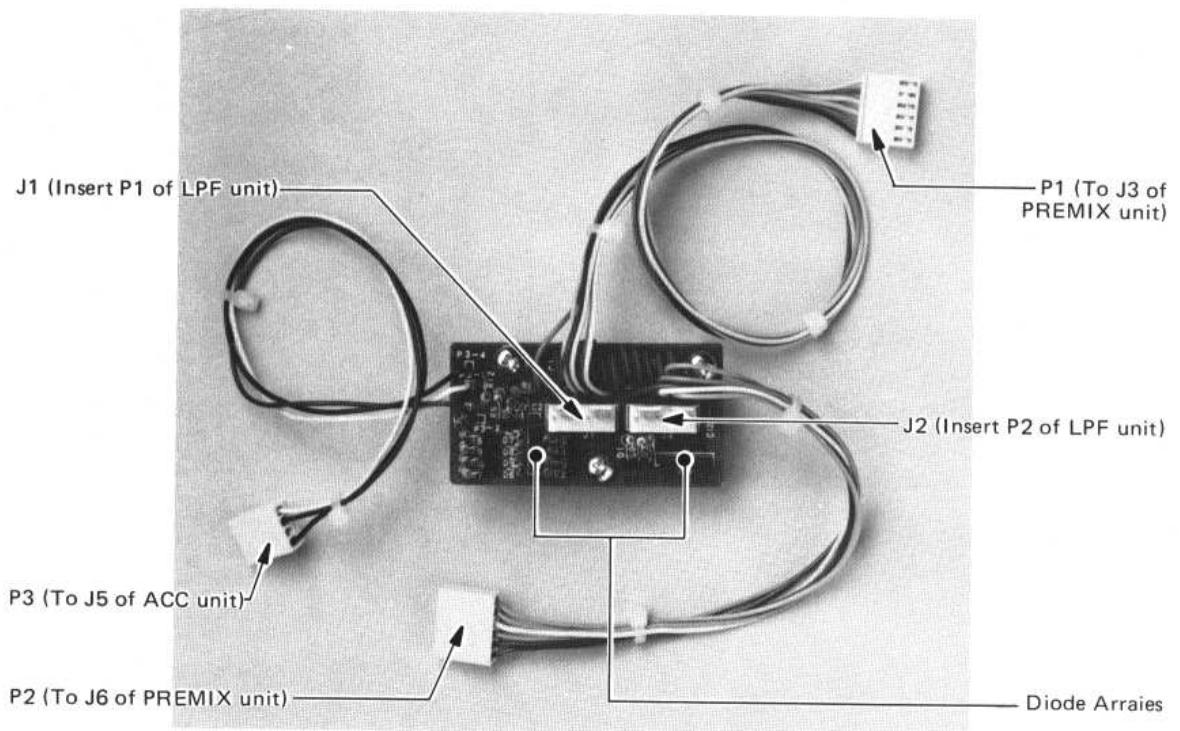

-11-

3-3-2 INSTALLATION PROCEDURE

- ① Loosen the two retaining screws of the upper sub-chassis, and turn the sub-chassis around hinges on the other end as shown in the photo.

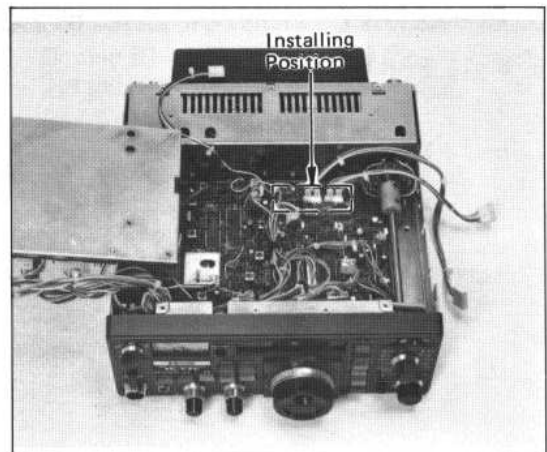
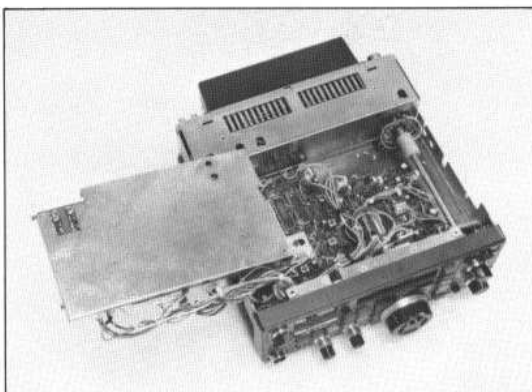

- ② Install this unit to the position shown in the photo using the screws that have been attached.
- ③ Unplug P1 and P2 from J3 and J6 of the PREMIX unit located the bottom side.

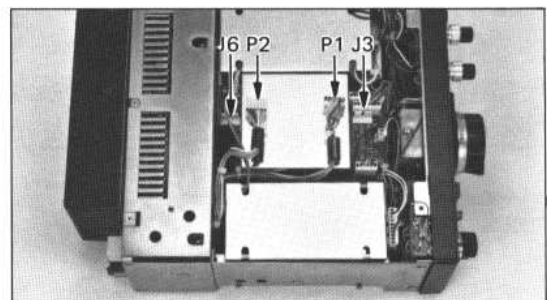

-12-

- ④ Loosen the screws of the shaft coupling sleeve of the band switch, and remove the shaft, sliding it towards the front side, then the sleeve and the spring pressing wafer of the band switch.

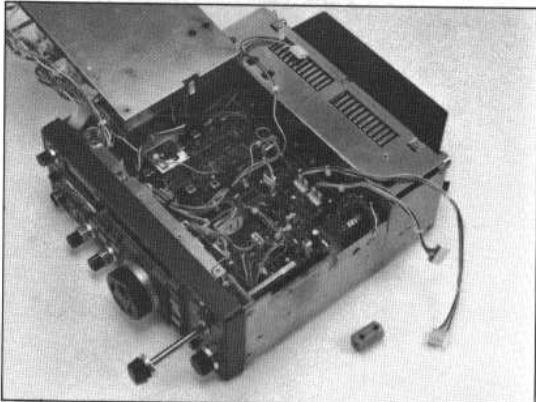

- ⑤ Remove the wafer of the band switch from its shaft, taking care not to damage the wafer.

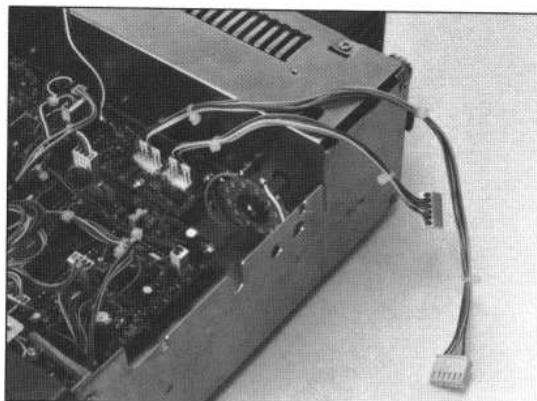

- ⑥ Remove the cover of the PLL unit, and unplug connectors inserted to the unit. Then unscrew the four screws retaining the unit, and remove the unit from the chassis.

- ⑦ Remove the wafer and its wiring harness through the slot under the band switch toward upper side.

-13-

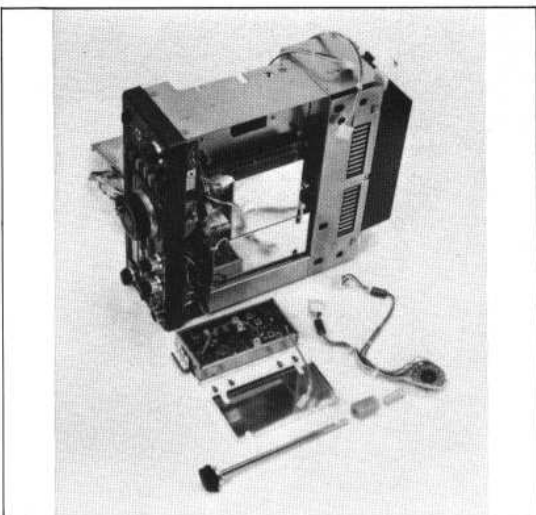

- ⑧ Run the cords with P1 and P2 of the LDA unit through the slot under the band switch. Plug P1 (6-pin plug attached to longer wires) to J3 and P2 (6-pin plug) to J6 of the PREMIX unit, so that the colors of the wires are the same order. Replace the PLL unit by the reverse procedure of ⑥.

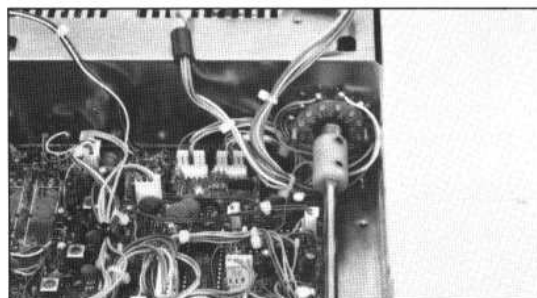
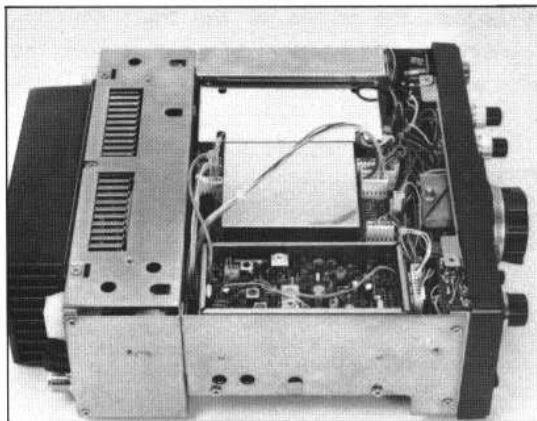

-14-

- ⑨ Replace the wafer, spring, shaft and shaft coupling sleeve by the reverse procedure of ④ and ⑤.
- ⑩ Plug P1 (6-pin plug attached to longer wires) of the switch wafer to J1 of the LDA unit and P2 (6-pin plug) to J2.

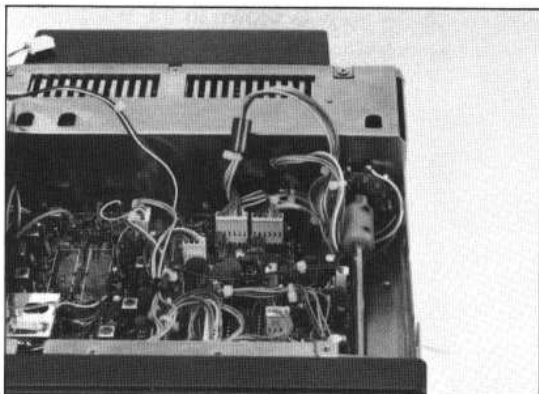

- ⑪ Remove the eight screws at each end of the rear panel.

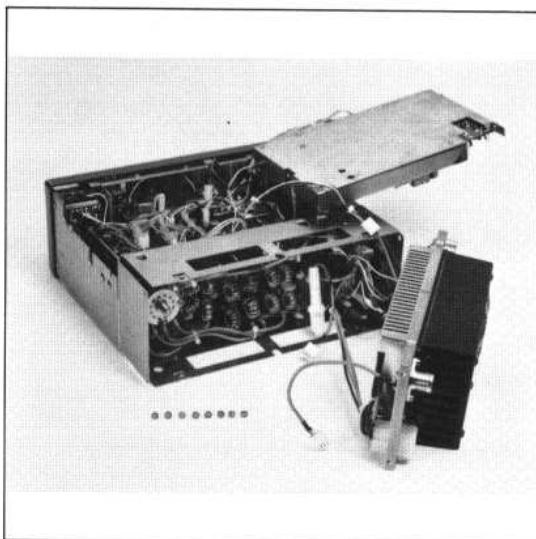
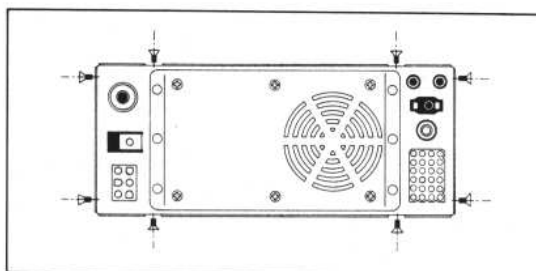

-15-

- ⑫ Turn over the rear panel right side, and unplug coaxial cables from J1 and J3 on the LPF board.

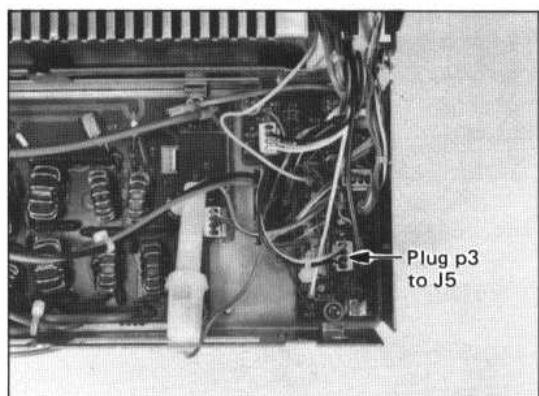

- ⑬ Run the cord with P3 (4-pin plug) of the LDA unit through the slot at the right corner of the rear box. Then plug P3 to J5 of the ACC unit.
- ⑭ Replace unplugged connectors and the rear panel by the reverse procedure of ⑪ and ⑫.

This unit has no requirement for adjustment for operation.

3 - 3 - 3 CHECKING THE OPERATION

Connect a multimeter across Pin 13 (+) and Pin 8 (-) of the accessory socket on the rear panel.

Make sure the voltage shown in the chart is put out across the pins on each band.

Band Control Voltage Chart

BAND (MHz)	Band Control Voltage
3.5	6.0 ~ 6.5V
7	5.0 ~ 5.5V
14	4.0 ~ 4.5V
18 - 21	3.0 ~ 3.5V
24 - 28	2.0 ~ 2.5V
10	0 ~ 1.2V

-16-

3 - 4 INSTALLATION OF IC-EX205 (TRV UNIT)

3 - 4 - 1 PARTS LAYOUT

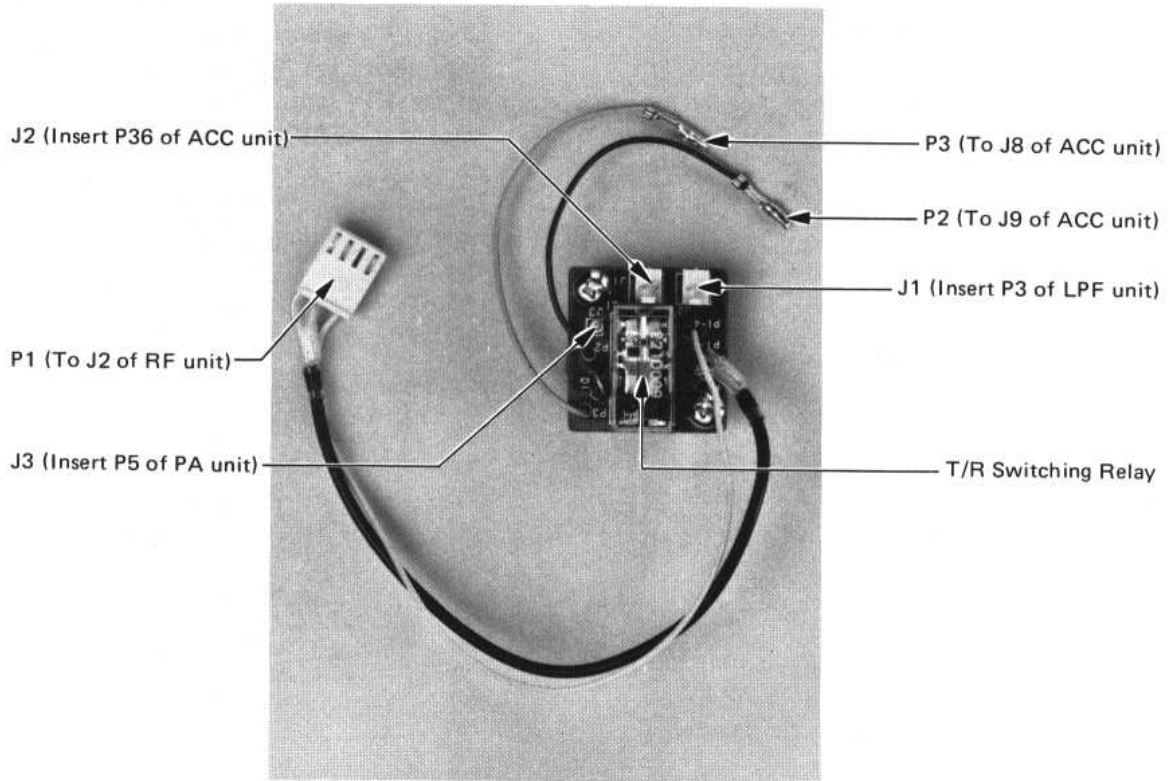

-17-

3 - 4 - 2 INSTALLATION PROCEDURE

- ① Remove the eight screws at each end of the rear panel. (Refer to the figure on page 15.)
- ② Turn over the rear panel right side or put it on the chassis, and unplug coaxial cables from J1 and J3 on the LPF unit.
- ③ Install this unit to the position shown in the photo using the screws that have been attached.

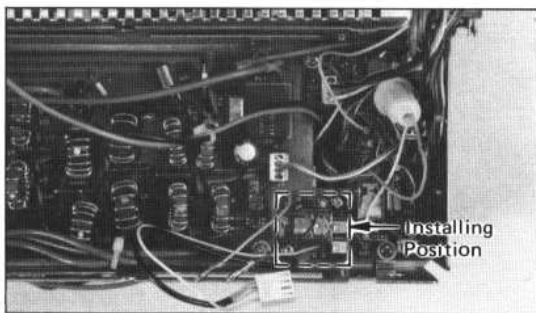

- ④ Connect P2 (with green wire) to J9 on the ACC unit, unplug P36 (2-pin plug) inserted

J2 on the ACC unit, and plug it to J2 on the TRV unit.

Unplug P5 (orange wire from the PA unit) from J8 on the ACC unit and plug it to J3 on the TRV unit, and plug P3 (with orange wire) of the TRV unit to J8 on the ACC unit.

Unplug P3 (2-pin plug with coaxial cable from the LPF unit) from J2 on the RF unit, and plug it to J1 on the TRV unit. Then plug P1 (4-pin plug) of the TRV unit to J2 on the RF unit.

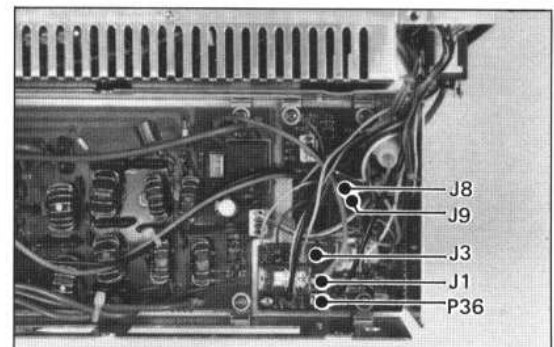

-18-

- ⑤ Replace unplugged connectors and the rear panel by the reverse procedure of ① and ②.

3-4-3 OPERATION

This unit has no requirement for adjustment for the operation.

When the transverter control signal (+8V) is applied to Pin 11 of the ACCESSORY socket, the ALC terminal on the rear panel can be used for a VHF/UHF transverter INPUT/OUTPUT terminal.

The transverter's input/output frequency and signal level should be as follows:

- Transverter INPUT/OUTPUT Frequency
28 ~ 30MHz
- Input/Output signal level
Transmit (Output): Max 150mV across a 50 ohm load
Receive (Input): 1 μ V for S/N 10dB

When the mechanical filter is "MF-455-11AZ", also remove C75 ~ C78 around the filter. (In the case of "MF-455-11GZ", C75 ~ C78 are not used.)

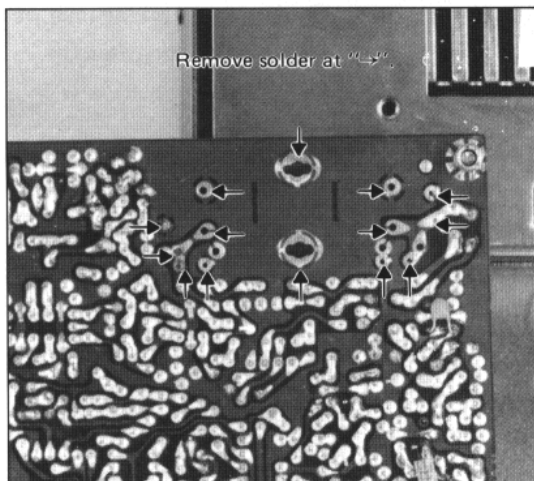

- ③ Insert the FL-44 to the position where the mechanical filter was installed and retain it by two supplied nuts then solder its terminal pins.

3-5 INSTALLATION OF THE FL-44

3-5-1 INSTALLATION PROCEDURE

- ① Unscrew the screws retaining the MAIN unit board and DET unit board, then turn them over so that foil side of the boards can be seen.

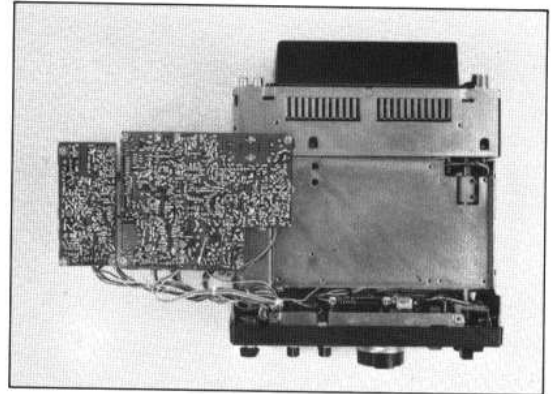

- ② Remove the solder of the mechanical filter's terminal Pins and legs on the foil of the MAIN unit, by a de-soldering braid, then take off the mechanical filter.

-19-

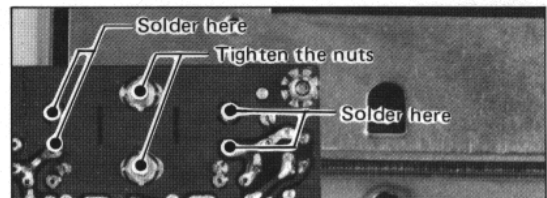

- ④ Replace the MAIN unit board and the DET unit board to the chassis by the reverse procedure of ①.
- ⑤ No adjustment is required for operation.

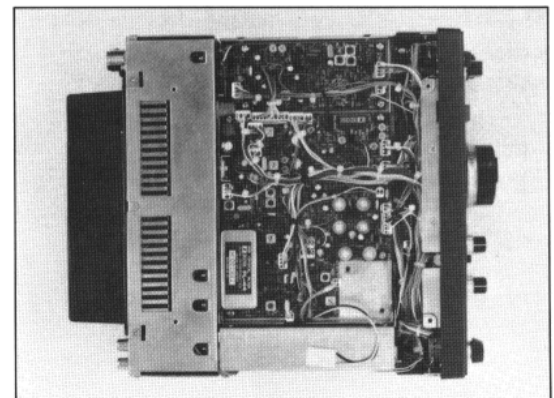

-20-

3 - 6 INSTALLATION OF THE FL-30

3 - 6 - 1 INSTALLATION PROCEDURE

- ① Loosen two retaining screws of the upper sub-chassis, and turn the sub-chassis over around hinges on the other end as shown in the photo.

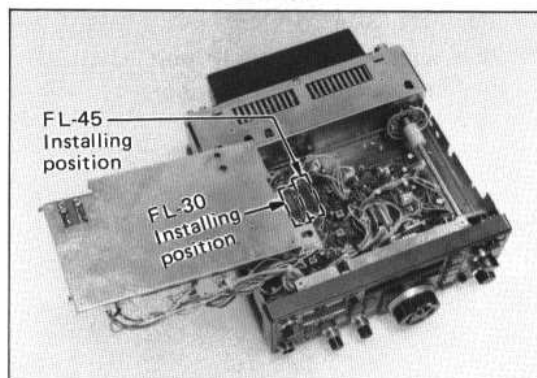

- ② Unscrew the screws retaining the 2nd IF unit board, then turn it over so that foil side of the board can be seen.

Trim the leads even with the solder points.
This completes the installation.

- ④ Replace the 2nd IF unit, and unplug P3 inserted to J7 on the unit, then plug it to J8.

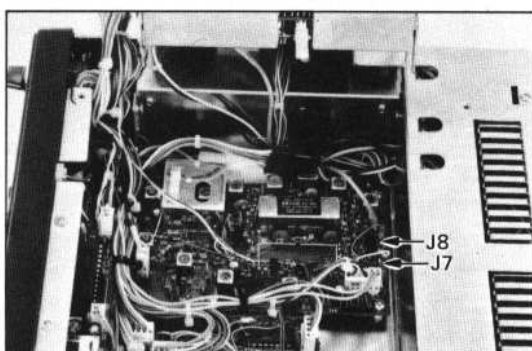

- ⑤ Replace the sub-chassis by the reverse procedure of ①.

No adjustment is required, and the filter provides the Pass-Band Tuning system.

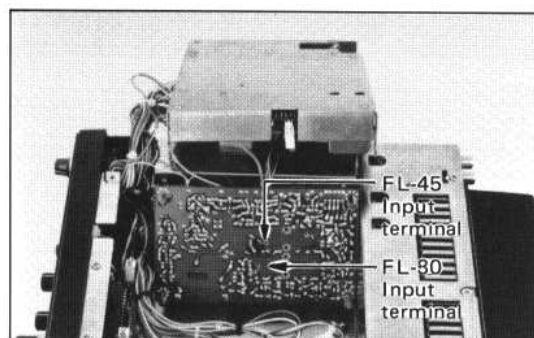

- ③ The location for the filter is shown in the photo. The holes for mounting the legs and the leads of the filter are predrilled.

Be sure to orient the filter so that the input terminal (indicated on the bottom) of the filter is facing the same direction as shown on the photo.

Insert the filter flush with the board, bend the leads and legs flush with the opposite side of the board and solder them in.

-21-

3 - 7 INSTALLATION OF THE FL-45

3 - 7 - 1 INSTALLATION PROCEDURE

- ① Install the filter by the same procedure of the FL-30.
- ② The location for the filter is shown on the photo of 3 - 6 - 1 on page 21.
- ③ After replacing the 2nd IF unit board, unplug P2 inserted to J5, then plug it to J6 on the 2nd IF unit board.

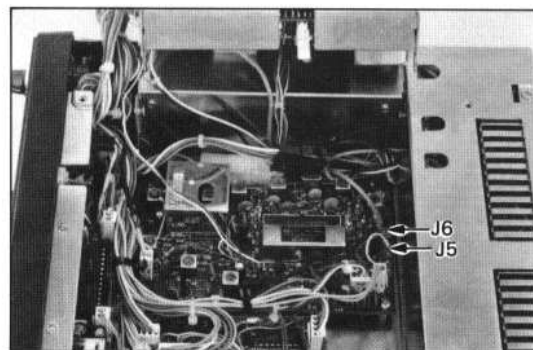

- ④ No adjustment is required, and the filter provides 500Hz/6 dB pass-band.

-22-

4. SCHEMATIC DIAGRAM

IC-EX195

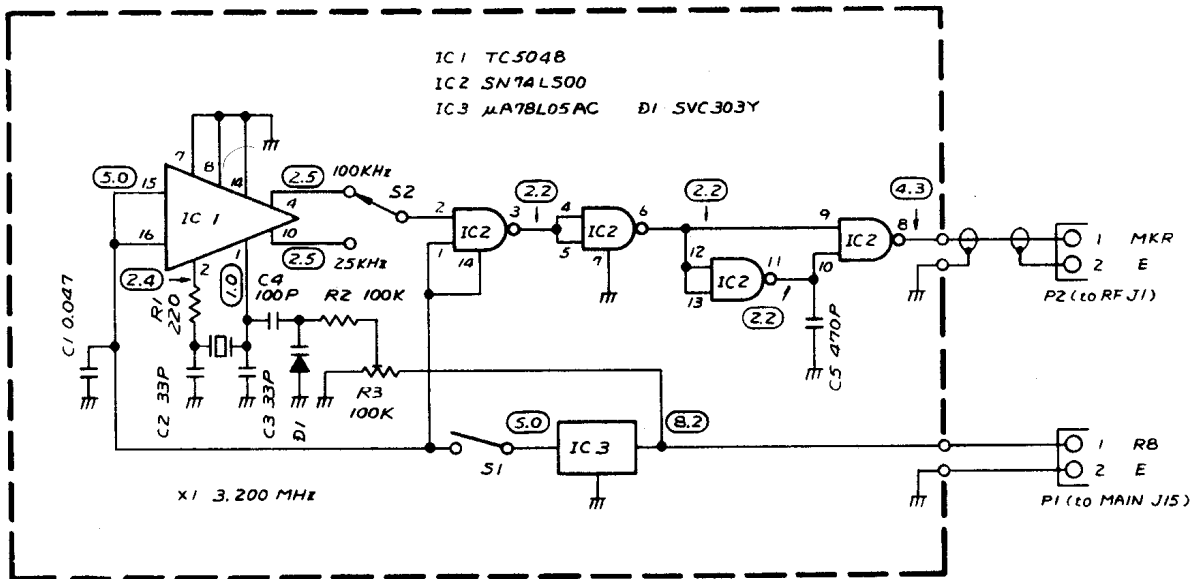

IC-EX205

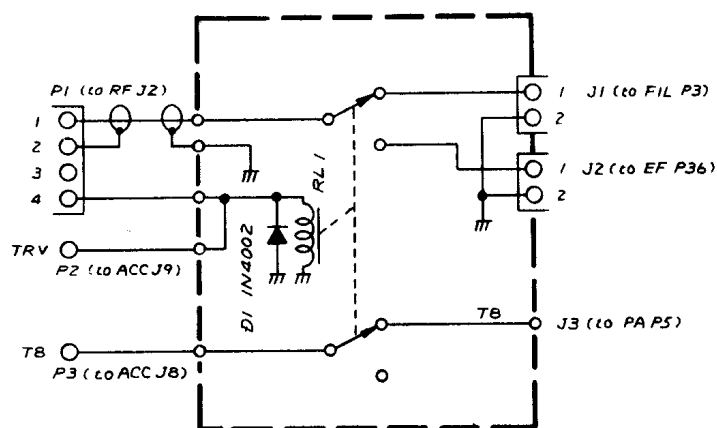

4. SCHEMATIC DIAGRAM

IC-EX202

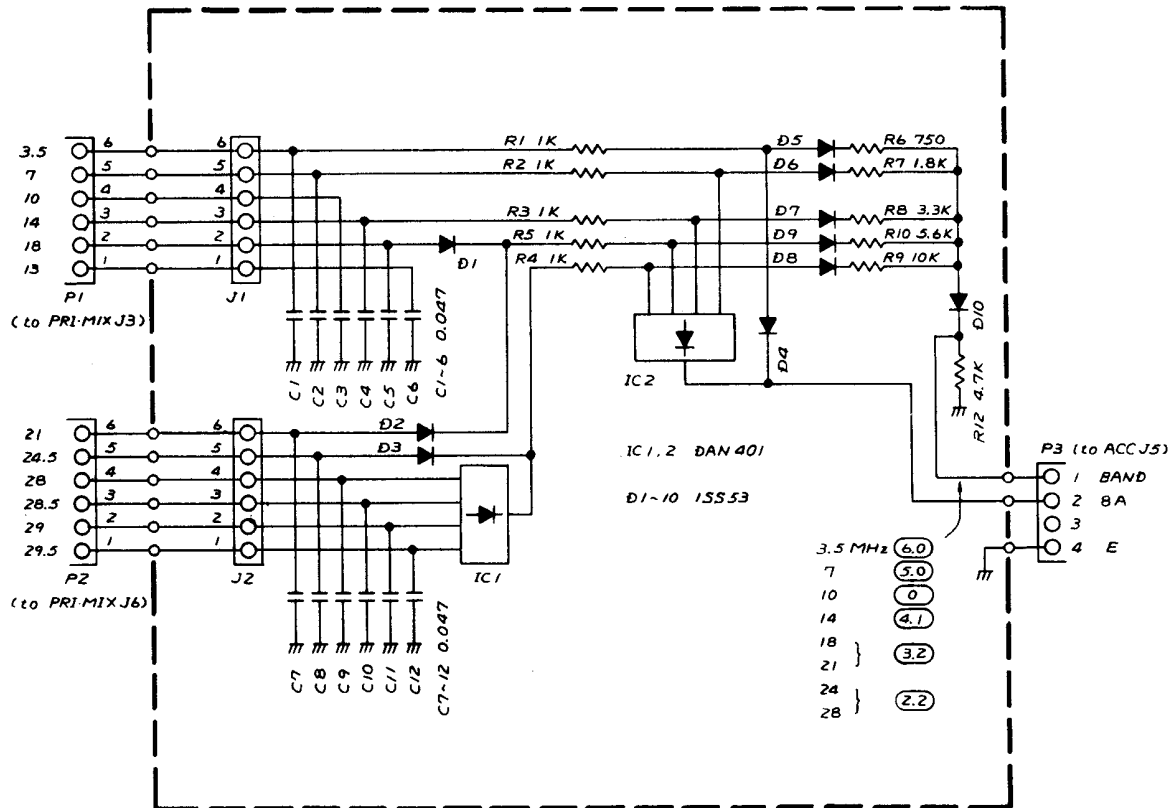

IC-EX203

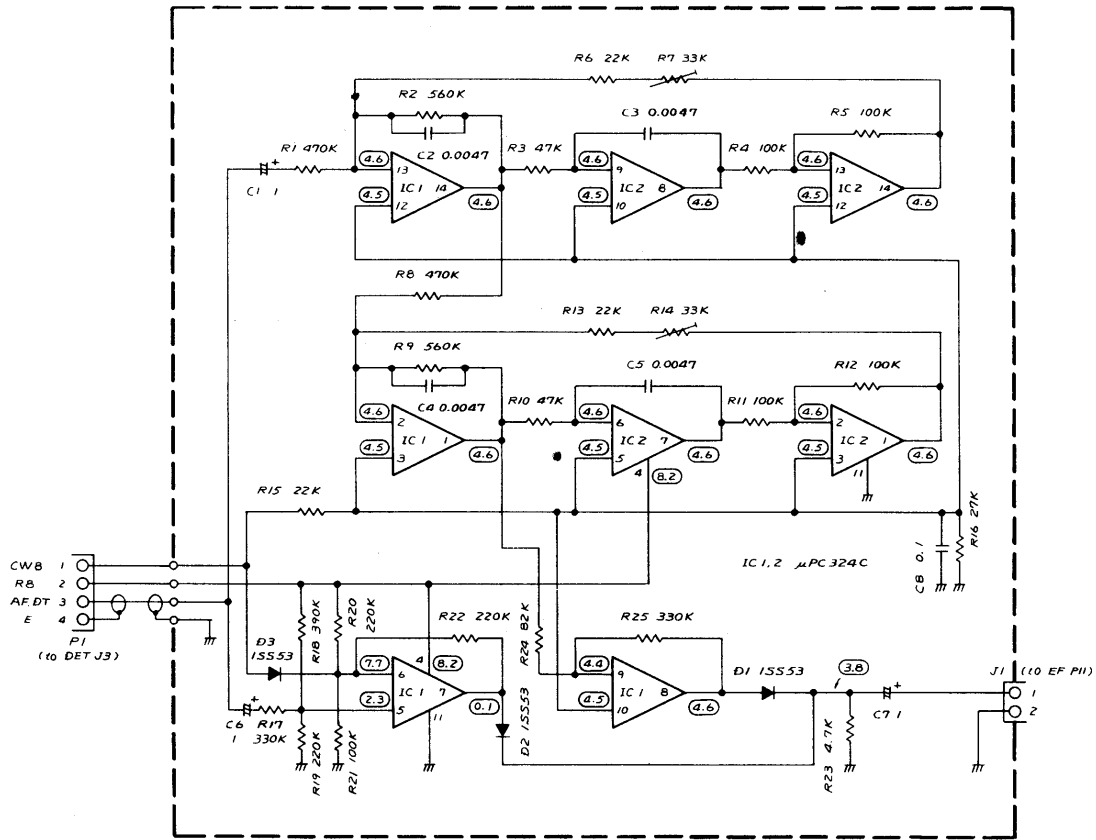

Some components subject to change for an improvement without notice.