



SERVICE MANUAL

HF/50MHz ALL BAND TRANSCEIVER

IC-756PRO

INTRODUCTION

This service manual describes the latest service information for the **IC-756PRO** HF/50MHz ALL BAND TRANSCEIVER.

MODEL	VERSION	SYMBOL
IC-756PRO	U.S.A.	USA
	Europe	EUR
	France	FRA

To upgrade quality, any electrical or mechanical parts and internal circuits are subject to change without notice or obligation.

DANGER

NEVER connect the transceiver to an AC outlet or to a DC power supply that uses more than 16 V. This will ruin the transceiver.

DO NOT expose the transceiver to rain, snow or any liquids.

DO NOT reverse the polarities of the power supply when connecting the transceiver.

DO NOT apply an RF signal of more than 20 dBm (100 mW) to the antenna connector. This could damage the transceiver's front end.



ORDERING PARTS

Be sure to include the following four points when ordering replacement parts:

1. 10-digit order numbers
2. Component part number and name
3. Equipment model name and unit name
4. Quantity required

<SAMPLE ORDER>

1110000960 S.IC NJM4558M IC-756PRO MAIN UNIT 5 pieces
8810005770 Screw BiH M3x8 ZK IC-756PRO Top cover 10 pieces
Addresses are provided on the inside back cover for your convenience.

REPAIR NOTES

1. Make sure a problem is internal before disassembling the transceiver.
2. **DO NOT** open the transceiver until the transceiver is disconnected from its power source.
3. **DO NOT** force any of the variable components. Turn them slowly and smoothly.
4. **DO NOT** short any circuits or electronic parts. An insulated tuning tool **MUST** be used for all adjustments.
5. **DO NOT** keep power ON for a long time when the transceiver is defective.
6. **DO NOT** transmit power into a signal generator or a sweep generator.
7. **ALWAYS** connect a 50 dB to 60 dB attenuator between the transceiver and a deviation meter or spectrum analyzer when using such test equipment.
8. **READ** the instructions of test equipment thoroughly before connecting equipment to the transceiver.

TABLE OF CONTENTS

SECTION 1	SPECIFICATIONS	
SECTION 2	INSIDE VIEWS	
SECTION 3	CIRCUIT DESCRIPTION	
3 - 1	RECEIVER CIRCUITS	3 - 1
3 - 2	TRANSMITTER CIRCUITS	3 - 4
3 - 3	PLL CIRCUITS	3 - 6
3 - 4	ANTENNA TUNER CIRCUITS	3 - 7
3 - 5	SCOPE CIRCUIT	3 - 8
3 - 6	POWER SUPPLY CIRCUITS	3 - 9
3 - 7	LOGIC CIRCUITS	3 - 10
SECTION 4	ADJUSTMENT PROCEDURES	
4 - 1	PREPARATION BEFORE SERVICING	4 - 1
4 - 2	PLL ADJUSTMENTS	4 - 2
4 - 3	RECEIVER ADJUSTMENTS	4 - 4
4 - 4	TRANSMITTER ADJUSTMENTS	4 - 8
4 - 5	TUNER ADJUSTMENT	4 - 10
SECTION 5	PARTS LIST	
SECTION 6	MECHANICAL PARTS	
SECTION 7	SEMI-CONDUCTOR INFORMATION	
SECTION 8	BOARD LAYOUTS	
8 - 1	PBT, RIT AND MIC BOARDS	8 - 1
8 - 2	DISPLAY BOARD	8 - 2
8 - 3	MODE, PHONE, KEY AND TEN-KEY BOARDS	8 - 4
8 - 4	RF UNIT	8 - 6
8 - 5	PLL UNIT	8 - 8
8 - 6	MAIN UNIT	8 - 10
8 - 7	DSP BOARD	8 - 12
8 - 8	MEMORY BOARD	8 - 13
8 - 9	PA UNIT	8 - 14
8 - 10	FILTER UNIT	8 - 15
8 - 11	TUNER BOARD	8 - 16
8 - 12	CTRL UNIT	8 - 17
SECTION 9	BLOCK DIAGRAM	
SECTION 10	VOLTAGE DIAGRAM	
10 - 1	FRONT UNIT	10 - 1
10 - 2	DSP BOARD	10 - 2
10 - 3	TUNER, MEMORY BOARDS AND CTRL UNIT	10 - 3
10 - 4	MAIN UNIT (1)	10 - 4
10 - 5	MAIN UNIT (2)	10 - 5
10 - 6	PLL UNIT	10 - 6
10 - 7	PA AND FILTER UNITS	10 - 7
10 - 8	RF UNIT	10 - 8

SECTION 1 SPECIFICATIONS

■ GENERAL

- Frequency coverage:
 - Receive 0.030–60.000 MHz^{*1, *2}
 - Transmit 1.800–1.999 MHz^{*2} 3.500–3.999 MHz^{*2}
 - 7.000–7.300 MHz^{*2} 10.100–10.150 MHz^{*2}
 - 14.000–14.350 MHz^{*2} 18.068–18.168 MHz^{*2}
 - 21.000–21.450 MHz^{*2} 24.890–24.990 MHz^{*2}
 - 28.000–29.700 MHz^{*2} 50.000–54.000 MHz^{*2}
- *1 Some frequency bands are not guaranteed.
- *2 Depending on version.
- Mode : USB, LSB, CW, RTTY, AM, FM
- Number of memory channels : 101 (99 regular, 2 scan edges)
- Antenna connector : SO-239 x 2 and phono [(RCA); 50 Ω]
- Usable temp. range: –10°C to +50°C (14°F to 122°F)
- Frequency stability : Less than ±0.5 ppm from 1 min. after power ON.
- Freq. resolution : 1 Hz
- Power supply : 13.8 V DC ±15 % (negative ground) requirement
- Current consumption:
 - Transmit max. power 23 A
 - Receive stand-by 3.0 A (typical)
 - max. audio 3.3 A (typical)
- Dimensions : 340 (W) x 111(H) x 285(D) mm
13³/₈(W) x 4³/₈(H) x 11⁷/₃₂(D) in
- Weight : 9.6 kg (21 lb 1 oz)
- ACC 1 connector : 8-pin DIN connector
- ACC 2 connector : 7-pin DIN connector
- CI-V connector : 2-conductor 3.5(d) mm (1/8")
- Display : 5-inch (diagonal) TFT color LCD

■ TRANSMITTER

- Output power :
 - SSB/CW/RTTY/FM 5–100 W
 - AM 5–40 W
- Modulation system :
 - SSB PSN modulation
 - AM Low power modulation
 - FM Phase modulation
- Spurious emission : Less than –50 dB (HF bands)
Less than –60 dB (50 MHz band)
- Carrier suppression: More than 40 dB
- Unwanted sideband suppression: More than 55 dB
- ΔTX variable range : ±9.999 kHz
- Mic. connector : 8-pin connector (600 Ω)
- ELE-KEY connector: 3-conductor 6.35(d) mm (1/4")
- KEY connector : 3-conductor 6.35(d) mm (1/4")
- SEND connector : Phono (RCA)
- ALC connector : Phono (RCA)

■ RECEIVER

- Receive system : Triple-conversion superheterodyne
- Intermediate frequencies:
 - 1st IF frequency 64.455 MHz
 - 2nd IF frequency 455 kHz
 - 3rd IF frequency 36 kHz
- Sensitivity :
 - SSB, CW, RTTY (at 2.4 kHz bandwidth)
 - 1.8–29.99 MHz^{*1} 0.16 μV (10 dB S/N)
 - 50.0–54.0 MHz^{*2} 0.13 μV (10 dB S/N)
 - AM (at 6.0 kHz bandwidth)
 - 0.5–1.799 MHz 13 μV (10 dB S/N)
 - 1.8–29.99 MHz^{*1} 2.0 μV (10 dB S/N)
 - 50.0–54.0 MHz^{*2} 1.0 μV (10 dB S/N)
 - FM (at 15 kHz bandwidth)
 - 28.0–29.99 MHz^{*1} 0.5 μV (12 dB SINAD)
 - 50.0–54.0 MHz^{*2} 0.32 μV (12 dB SINAD)
- *1 Pre-amp 1 ON *2 Pre-amp 2 ON
- Squelch sensitivity : (Pre-amp OFF)
 - SSB/CW/RTTY Less than 5.6 μV
 - FM Less than 1.0 μV
- Selectivity :
 - SSB/RTTY (at 2.4 kHz bandwidth)
 - More than 2.4 kHz/–6 dB
 - Less than 2.8 kHz/–60 dB
 - CW (at 500 Hz bandwidth)
 - More than 500 Hz/–6 dB
 - Less than 700 Hz/–60 dB
 - AM (at 6 kHz bandwidth)
 - More than 6.0 kHz/–6 dB
 - Less than 15.0 kHz/–60 dB
 - FM (at 15 kHz bandwidth)
 - More than 12 kHz/–6 dB
 - Less than 20 kHz/–60 dB
- Spurious and image: More than 70 dB rejection ratio (except IF through in 50 MHz band)
- RIT variable range : ±9.999 kHz
- Audio output power : More than 2.0 W at 10 % distortion (at 13.8 V DC) with an 8 Ω load
- PHONES connector: 3-conductor 6.35 (d) mm (1/4")
- EXT SP connector : 2-conductor 3.5 (d) mm (1/8") 8 Ω

■ ANTENNA TUNER

- Matching impedance range:
 - HF bands 16.7 to 150 Ω unbalanced^{*1}
 - 50 MHz band 20 to 125 Ω unbalanced^{*2}
- *1 Less than VSWR 3:1; *2 Less than VSWR 2.5:1
- Minimum operating input power:
 - HF bands : 8 W
 - 50 MHz band : 15 W
- Tuning accuracy : VSWR 1.5:1 or less
- Insertion loss : Less than 1.0 dB (after tuning)

All stated specifications are subject to change without notice or obligation.

SECTION 2 INSIDE VIEWS

• BOTTOM VIEW

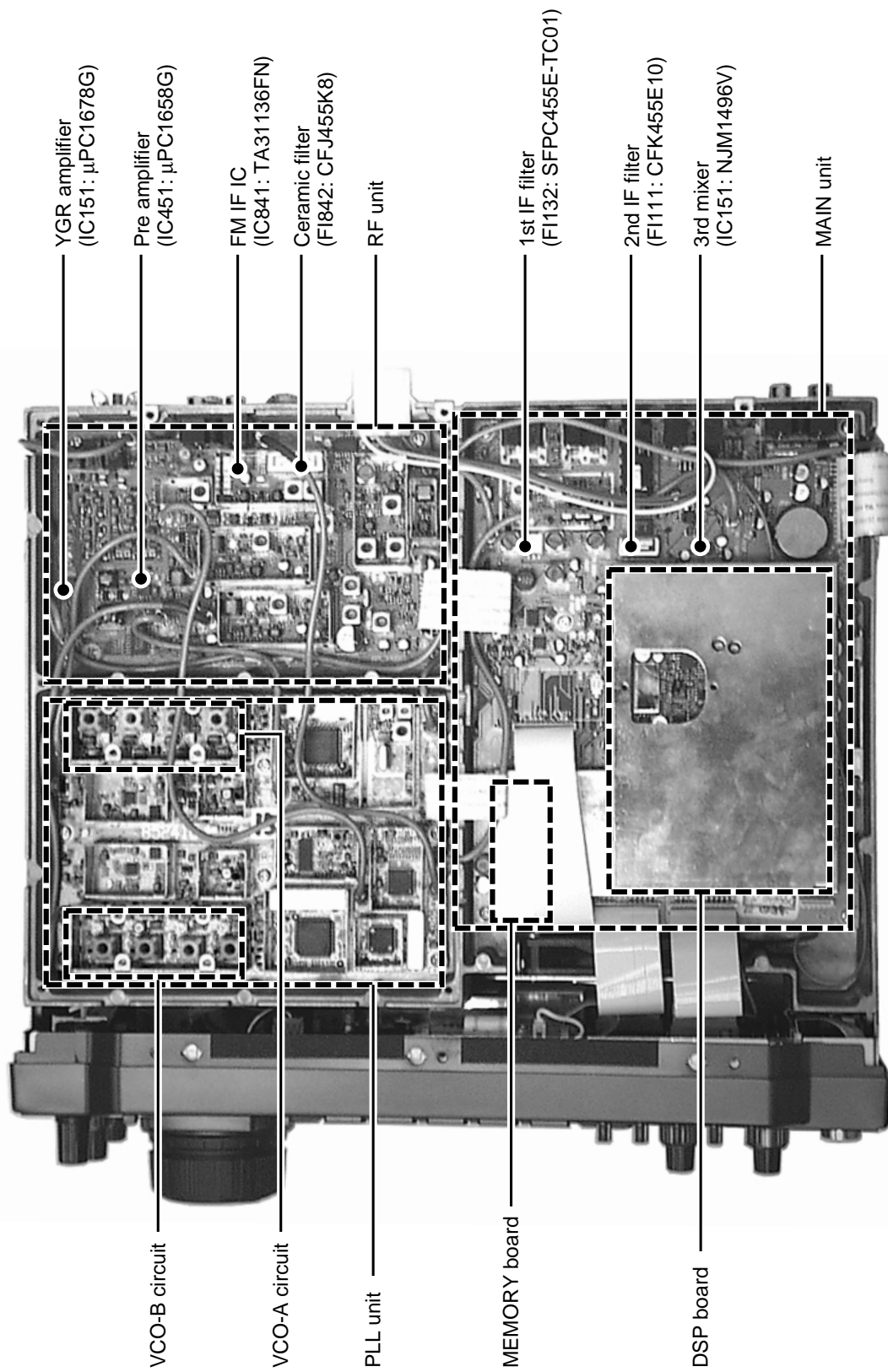

• TOP VIEW

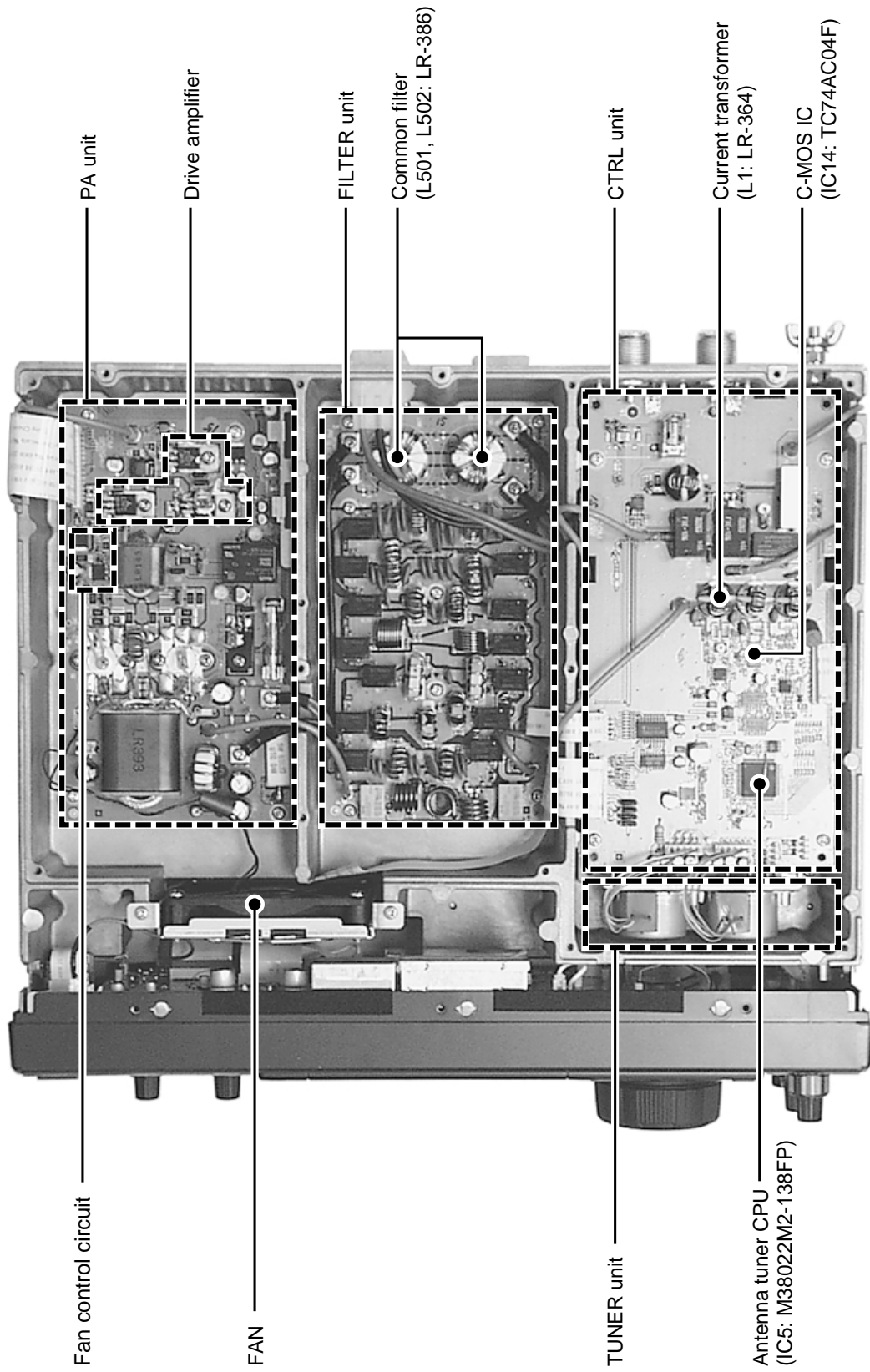

SECTION 3 CIRCUIT DESCRIPTION

3-1 RECEIVER CIRCUITS

3-1-1 RF SWITCHING CIRCUIT (CTRL AND RF UNITS)

The RF switching circuit leads receive signals to bandpass filters from an antenna connector while receiving. However, the circuit leads the signal from the RF power amplifier to the antenna connector while transmitting.

RF signals from [ANT 1] or [ANT 2] pass through the antenna selector (RL3), transmit/receive switching relays (RL1, RL2, RL4), and low-pass filter (L27, L28, C63–C66, C105), and are then applied to the RF unit via J2.

The signals from the CTRL unit either bypass or pass through the 6 dB (RF unit, RL121, R121) and/or 12 dB (RF unit, RL122, R123) attenuators via the antenna selector (RL101). By selecting the attenuators, 0 (bypass), 6, 12 and 18 dB attenuations are obtained. The signals are then applied to the RF filters.

When the [RX ANT] is selected, the RF signals are passed through the low-pass filter (RF unit, L112, L111, C111–C116), then applied to the antenna selector (RF unit, RL101).

3-1-2 RF BANDPASS FILTER CIRCUIT (RF UNIT)

RF bandpass filters pass only the desired band signals and suppress any undesired band signals. The RF circuit has 11 bandpass filters and 1 low-pass filter.

(1) 0.03–1.6 MHz

The signals pass through the low-pass filter (L181–L183, C181–C185), attenuator (R181–R183), and are then applied to the RF amplifiers (Q501, Q601).

(2) 1.6–60 MHz

The signals pass through the high-pass filter (L171–L174, C171–C174) to suppress excessively strong signals below 1.6 MHz. The filtered signals are applied to one of 11 bandpass filters as below, and then applied to or bypassed the pre-amplifier circuit.

• Used RF filter

Band	Control signal	Input diode	Band	Control signal	Input diode
0.03–1.6 MHz	B0	N/A	11–15 MHz	B7	D311
1.6–2 MHz	B1	D191	15–22 MHz	B8	D231
2–3 MHz	B2	D211	22–30 MHz	B9	D291½
3–4 MHz	B3	D231½	30–50 MHz	B10W	D391
4–6 MHz	B4	D231½	50–54 MHz	B10	D371
6–8 MHz	B5	D271	54–60 MHz	B10W	D391
8–11 MHz	B6	D291½			

3-1-3 PRE-AMPLIFIER CIRCUITS (RF UNIT)

The IC-756PRO has 2 gain levels of pre-amplifier circuits. One has 10 dB gain over a wide band frequency range and the other one has 16 dB gain for the 21–28 MHz bands.

When the [PREAMP] switch is set to [PRE1] or [PRE2], the signals are applied to the pre-amplifier 1 (Q441, Q442) or pre-amplifier 2 (IC451) circuit, respectively. Pre-amplified or bypassed signals are applied to the RF amplifier circuits (Q501, Q601).

3-1-4 RF AMPLIFIER AND 1ST MIXER CIRCUITS (RF UNIT)

The 1st mixer circuit mixes the receive signals with the 1st LO signal to convert the receive signal frequencies into a 64.455 MHz 1st IF signal. The IC-756PRO has two 1st mixer circuits for the dualwatch function.

The signals from the pre-amplifier circuit, or signals which bypass the pre-amplifiers, are divided at L491. Each signal is applied to a 60 MHz cut-off low-pass filter, RF amplifier (Q501, Q601) and then to a 1st mixer (Q511–Q514 or Q611–Q614).

Each 1st LO signal (64.4850–124.4550 MHz) enters the RF unit from the PLL unit via J561 or J661. The LO signals are amplified at the LO amplifier (Q561 or Q661), filtered by a low-pass filter, and then applied to each 1st mixer.

• Receiver construction

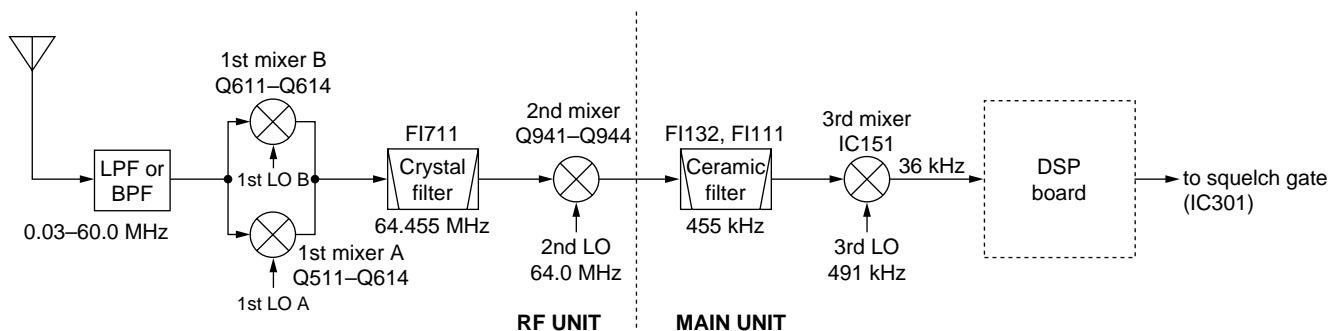

3-1-5 1ST IF CIRCUIT (RF UNIT)

The 1st IF circuit filters and amplifies the 1st IF signal. The 1st IF signal combined at L653 is applied to an MCF (Monolithic Crystal Filter; FI711a/b) to suppress out-of-band signals.

The converted 1st IF signal level is adjusted at PIN attenuators (D531–D533, D535 or D631–D632, D635) controlled by the [BAL] controller for the dualwatch function. The signal is applied to the 1st IF amplifier (Q551 or Q651) and then combined at L653.

The combined signal passes through the MCFs (FI711a/b) and PIN attenuator (D781, D783). The signal is amplified at the 1st IF amplifier (Q721). The amplified signal is then applied to the 2nd mixer circuit.

3-1-6 2ND MIXER CIRCUIT (RF UNIT)

The 2nd mixer circuit mixes the amplified 1st IF signal and 2nd LO signal (64.00 MHz) for conversion into the 2nd IF signal.

The 1st IF signal from the 1st IF amplifier (Q721) is converted into a 455 kHz 2nd IF signal at the 2nd mixer circuit (Q941–Q944).

The 2nd IF signal is applied to the ceramic filter (MAIN unit, FI131) to suppress un-desired signals, and then applied to the noise blanker gate.

3-1-7 NOISE BLANKER CIRCUIT (MAIN UNIT)

The noise blanker circuit detects pulse-type noise, and turns OFF the signal line when the noise appears.

The 2nd IF signal from the ceramic filter (FI132) is applied to the noise blanker gate (D112, D116). A portion of the signal from FI132 is amplified at the noise amplifiers (Q271–Q273), and is then detected at the noise detector (D271) to convert the noise components to DC voltages.

The signal is then applied to the noise blanker switch (Q276, Q278). At the moment the detected voltage exceeds Q276's threshold level, Q278 outputs a blanking signal to close the noise blanker gate (D112, D116). The PLL unlock signal are also applied to Q278, to control the noise blanker gate.

• DSP receiver circuit

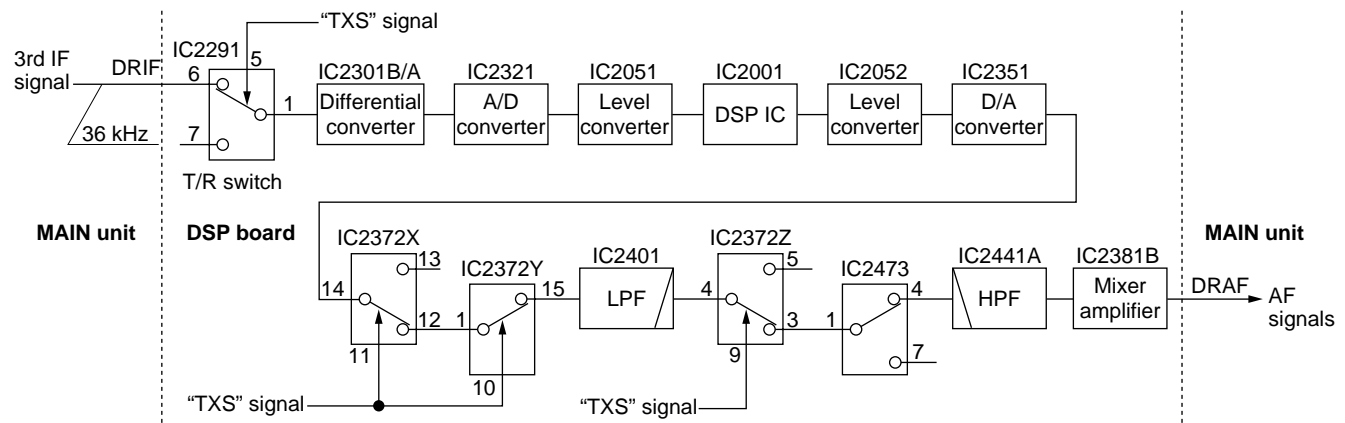

Some DC voltage from the noise detector circuit is fed back to the noise amplifiers (Q271–Q273) via the DC amplifiers (Q274, Q275). The DC amplifiers function as an AGC circuit to reduce average noise. Therefore, the noise blanker function shuts off pulse-type noise only.

3-1-8 2ND IF CIRCUIT (MAIN UNIT)

The 2nd IF circuit filters and applies the 2nd IF signal to the 3rd mixer circuit.

The 2nd IF signal from the noise blanker gate (D112, D116) is passed through the another ceramic filter (FI111). The filtered signal is applied to the 3rd mixer circuit.

3-1-9 3RD MIXER AND 3RD IF CIRCUITS (MAIN UNIT)

The 3rd mixer circuit mixes the 2nd IF signal and the 3rd LO signal to obtain the 3rd IF (36 kHz) signal.

The 2nd IF signal from the ceramic filter (FI111) is applied to the 3rd mixer circuit (IC151, pin 1). The 3rd LO signal from the PLL unit is applied to the 3rd mixer (IC151, pin 10). The mixed signal is output from pin 6.

The 3rd IF signal is amplified at the 3rd IF amplifier (IC201b), and is passed through the low-pass filter (IC201a). The filtered signal is then applied to the DSP board via DRIF line.

3-1-10 DSP RECEIVER CIRCUIT (DSP BOARD)

The DSP (Digital Signal Processor) board enables digital IF filter, digital noise reduction, digital PSN (Phase Shift Network)/Low Power/Phase demodulation, digital automatic notch, and etc.

The 36 kHz 3rd IF signal from the low-pass filter (MAIN unit, IC201a) is amplified at the differential amplifiers (IC2301a/b) after being passed through the T/R switch (IC2291), and is then applied to the A/D converter (IC2321). The converted signal is level shifted 5V to 3.3 V at the level converter (IC2051).

The level shifted signal is applied to the DSP IC (IC2001) for 36 kHz digital IF filter, demodulation, automatic notch and noise reduction, etc. The output signal is level shifted 3.3 V to 5V at the level converter (IC2052), and is applied to the D/A converter (IC2351) to convert into the analog audio signals.

The converted audio signals are passed through the active filter (IC2371a), AF amplifier (IC2371b), analog switches (IC2372, pins 14, 13 and pins 1, 15) then applied to the low-pass filter (IC2401). The filtered signals are passed through the analog switches (IC2372, pins 4, 3 and IC2473), high-pass filter (IC2441A) and mixer amplifier (IC2471A), and then applied to the MAIN unit via J2001 (pin 13) as the DTAF signal.

3-1-11 TWIN PBT CIRCUIT (DSP BOARD)

General PBT (Passband Tuning) circuit shifts the center frequency of IF signal to electronically narrow the passband width. The IC-756PRO uses the DSP circuit for the digital PBT function and actually shifts the both lower and higher passbands of 3rd IF filter within ± 1.8 kHz.

The twin PBT circuit in DSP IC (IC2001) controlled by the [TWIN PBT] controller adjusts the 3rd IF passband width and rejects interference.

3-1-12 AGC CIRCUIT (DSP BOARD)

The AGC (Automatic Gain Control) circuit reduces IF amplifier gain and attenuates IF signal to keep the audio output at a constant level.

The receiver gain is determined by the voltage on the AGC line (IC2461, pin 4). The D/A converter for AGC (IC2461) supplies control voltage to the AGC line and sets the receiver gain with the [RF/SQ] control.

The 3rd IF signal from the level converter (IC2051) is detected at the AGC detector section in DSP IC (IC2001), and is applied to the D/A converter for AGC via the level converter (IC2052). The AGC voltage is amplified at the buffer amplifier (IC2471b) and is applied to the MAIN unit to control the AGC line.

When receiving strong signals, the detected voltage increases and the AGC voltage decreases via the buffer amplifier (IC2471b). As the AGC voltage is used for the bias voltage of the IF amplifier (RF unit; Q721), IF amplifier gain is decreased. And also AGC voltage is amplified at the AGC amplifier (RF unit; IC871c) and applied to the ATT driver (Q781, D784) to drive the PIN attenuator (D781, D783).

• AF amplifier circuit

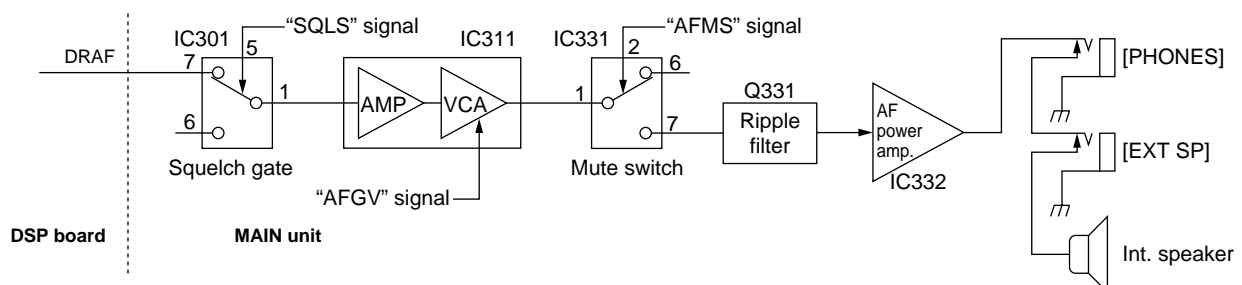

3-1-13 S-METER CIRCUIT (MAIN UNIT)

The S-meter circuit indicates the relative received signal strength while receiving by utilizing the AGC voltage which changes depending on the received signal strength.

A portion of the AGC bias voltage from the DSP board is applied to the differential amplifier (IC101a, pin 2) where the difference between the AGC and reference voltage is detected.

The detected voltage is passed through the analog switch (IC3631, pins 12, 14) as the SML signal and applied to the main CPU (IC3501, pin 108) to activate the S/Rf meter via the sub CPU (IC401) on the DISPLAY board.

3-1-14 SQUELCH CIRCUIT (MAIN UNIT)

The squelch circuit mutes audio output when the S-meter signal is lower than the [RF/SQ] setting level.

The S-meter signal is applied to the main CPU (IC3501, pin 108) and is compared with the threshold level set by the [RF/SQ] control. The [RF/SQ] setting signal is applied to the main CPU via the sub CPU (DISPLAY board; IC401, pin 91). The main CPU analyzes the compared signal and outputs control signal to the squelch gate (IC301, pin 5) via the interface IC (IC3653, pin 19) to open or close the squelch as the SQLS signal.

3-1-15 AF AMPLIFIER CIRCUIT (MAIN UNIT)

The AF amplifier amplifies the audio signals to a suitable driving level for the speaker.

The AF signals (DRAF) from the DSP board are passed through the squelch gate (IC301) and amplified at the AF amplifier section of IC311 (pins 2, 4) and volume is controlled by the AFGV signal at the VCA section (pins 7-9). The volume controlled AF signals are passed through the AF mute gate (IC331, pins 1, 7), then applied to the AF power amplifier (IC332, pin 1) via the ripple filter (Q331).

The amplified audio signals are passed through the [PHONES] and [EXT SP] jacks then applied to the internal speaker when no plug is connected to the jacks. The AF mute gate is controlled by the [AF] control via the sub and main CPUs.

3-2 TRANSMITTER CIRCUITS

3-2-1 MICROPHONE AMPLIFIER CIRCUIT (MAIN UNIT)

The microphone amplifier circuit amplifies microphone audio signals to a level needed for the DSP.

Audio signals from the [MIC] connector (MIC board; J1, pin 1) are amplified at the audio amplifier section in IC451 (pins 21–23) via the analog switch (IC3002, pins 12, 14), then applied to the buffer amplifier section (IC451, pin 5) and VCA section. The gain controlled signals are output from (IC451, pin 9) and passed through the analog switch (IC3005, pins 14, 12) and then applied to the DSP circuit as the DTAF signal.

The VCA section in IC451 (pins 7–9) controls microphone input gain according to the [MIC GAIN] control level using the MIGV signal coming from the main CPU via the I/O expander (IC3751, pin 4).

3-2-2 VOX CIRCUIT (MAIN UNIT)

The VOX (Voice-Operated Transmission) circuit sets transmitting conditions according to voice input.

A portion of the amplified audio signals from the AF amplifier section in IC451 are again amplified at the VOX amplifier section IC451 (pin 9), also gain controlled signals at the VCA section (pin 9) are amplified at the AF amplifier (IC3004b, pins 6, 7), and then applied to the main CPU (IC3501, pin 106) after passing through the analog switch (IC362, pins 6, 1) as the VOXL signal.

The VOGV signal is applied to the VCA section in IC3003 (pin 7–9) from the main CPU via the I/O expander (IC3751, pin 9) to adjust VOX actionable sensitivity. This is controlled by the VOX gain set in the VOX SET mode.

3-2-3 DSP TRANSMITTER CIRCUIT (DSP BOARD)

The microphone audio signals from the MAIN unit via the DTAF line are passed through the analog switch (IC2201, pins 4 and 3 or 5) and applied to the each modulation circuits.

(1) When SSB mode

The audio signals from the analog switch (IC2201, pin 5) are amplified at the limiter amplifier (IC2281b) and applied to the low-pass filter (IC2281d/c) to limit the transmit passband width.

The filtered signals are then applied to the differential amplifiers (IC2301a/b) via the analog switch (IC2201) and T/R switch (IC2291).

(2) When FM/AM modes

The audio signals from the analog switch (IC2201, pin 3) are applied to the deviation adjustment pots (R2227: FM mode, R2229: AM mode) via the limiter amplifier, pre-emphasis circuit (only FM mode) and splatter filter consist of IC2211.

The level adjusted signals are applied to the differential amplifiers (IC2301a/b) after being passed through the analog switch (IC2201) and T/R switch (IC2291). When AM mode the pre-emphasis circuit is cancelled by Q2201, Q2202, Q2211.

The amplified signals at the differential amplifiers (IC2301a/b) are applied to the A/D converter (IC2321). The converted signals are level shifted 5V to 3.3 V at the level converter (IC2051).

The level shifted signal is applied to the DSP IC (IC2001) and modulated at the DSP IC to produce the 36 kHz transmit IF signal. The modulated IF signal from the DSP IC is level shifted 3.3 V to 5V at the level converter (IC2052), and is applied to the D/A converter (IC2351) to convert into the analog IF signal.

The converted IF signal is passed through the active filter (IC2371a), buffer amplifier (IC2371b), analog switch (IC2372, pins 14, 12) then applied to the low-pass filter (IC2381c/d). The filtered signal is applied to the MAIN unit via J2001 (pin 28) as the DTIF signal.

A portion of the filtered signal from the low-pass filter (IC2381c/d) is amplified at the IF amplifier (IC2381b) and applied to the transmit monitor circuit for the monitor function.

3-2-4 SPEECH COMPRESSOR CIRCUIT (DSP BOARD)

The speech compressor compresses the transmitter audio input signals to increase the average output level (average talk power).

When the [COMP] switch is ON, the level shifted signal from the level converter (IC2051) is applied to the DSP IC (IC2001) and compressed at the DSP IC to obtain an average audio level.

At the same time, the compressed signals are modulated at the DSP IC and applied to the level converter (IC2052).

• Transmitter construction

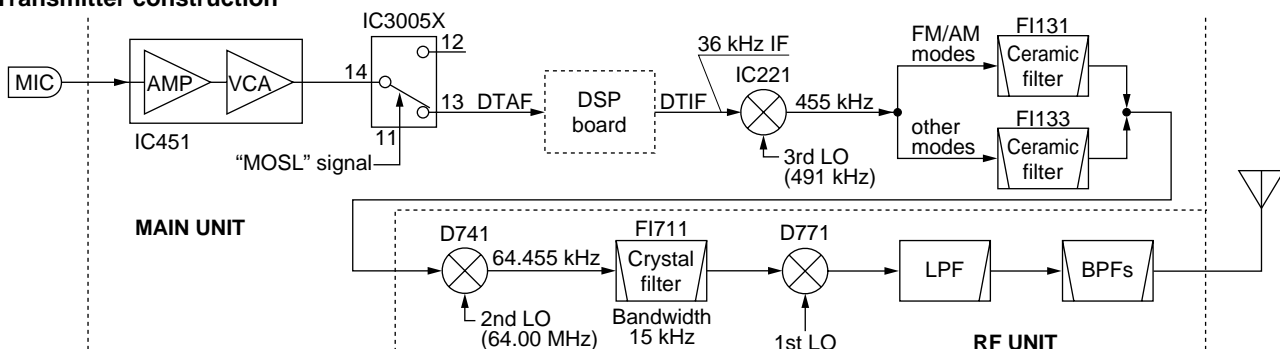

3-2-5 IF AMPLIFIER AND MIXER CIRCUITS (MAIN AND RF UNITS)

The modulated 3rd IF signal from the DSP board (DTIF: 36 kHz) is applied to the 3rd mixer circuit (MAIN unit; IC221). The applied 3rd IF signal is mixed with the 3rd LO signal from the DDS circuit (PLL unit; IC701) to produce a 455 kHz 2nd IF signal.

The 2nd IF signal is output from pin 6 and amplified at the IF amplifier (MAIN unit; Q241). The amplified signal is passed through the ceramic bandpass filter (MAIN unit; F1131: FM/AM modes, F1133: other modes) for unwanted signals are suppressed. The filtered 2nd IF signal is amplified at IF amplifier (MAIN unit; Q261) and applied to the 2nd mixer circuit on the RF unit via J101.

The 2nd IF signal is mixed with the 64 MHz 2nd LO signal, coming from the PLL unit, at the 2nd mixer circuit (RF unit; D741) to obtain a 64.455 MHz 1st IF signal. The 1st IF signal is passed through the MCF (RF unit; F1711) to cut-off the undesired signals then amplified at the IF amplifier (RF unit; Q751) via the T/R switch (RF unit; D711). The amplified 1st IF signal is applied to the 1st IF mixer circuit (RF unit; D771).

The operating (transmitting) frequency is produced at the 1st IF mixer circuit (RF unit; D771) by mixing the 1st IF and 1st LO signals. The mixed signal is then applied to the RF circuit.

3-2-6 RF CIRCUIT (RF AND PA UNITS)

The RF circuit amplifies operating (transmitting) frequency to obtain 100 W of RF output.

The signal from the 1st IF mixer is passed through the low-pass filter (RF unit; L961, L962, C961–C966) and amplified at the RF amplifier (RF unit; IC961). The amplified signal is again amplified at the wide-band YGR amplifier (RF unit; IC151) after passing through one of 11 bandpass (Refer to page 3-1 for bandpass filters used) and high-pass filters, and is then applied to the PA unit via J151.

The signal applied from the RF unit is amplified at the pre-drive (Q1), drive (Q2, Q3) and power amplifiers (Q4, Q5) in sequence to obtain a stable 100 W of RF output power. The

amplified signal is applied to one of 8 low-pass filters in the FILTER unit.

3-2-7 LOW-PASS FILTER CIRCUIT (FILTER UNIT)

The low-pass filter circuit contains 8 Chebyshev low-pass filters to suppress the higher harmonic components.

The signal from the power amplifiers in the PA unit is applied to one of the low-pass filters, which is selected by the I/O expander (IC11) in the CTRL unit via the buffer-amplifier (CTRL unit; IC12).

The filtered signal is then applied to one of 2 antenna connectors via the CTRL only/and TUNER unit/s.

3-2-8 ALC CIRCUIT (MAIN UNIT)

The ALC (Automatic Level Control) circuit controls the gain of IF amplifiers in order for the transceiver to output a constant RF power set by the [RF POWER] control even when the supplied voltage shifts, etc.

The RF power level is detected at one of the APC detector circuits (CTRL unit; D2) to be converted into DC voltage and applied to the MAIN unit as the FORV signal.

The FORV signal from the CTRL unit is applied to the comparator (IC551b, pin 6). The POCV signal, controlled by the [RF POWER] control via the I/O expander (IC3751, pin 5), is also applied to the other input (pin 5) for reference. The compared signal is output from pin 7 and applied to the IF amplifiers in the MAIN (Q261) and RF (Q751) units to control amplifying gain.

When the FORV signal exceeds the POCV voltage, ALC bias voltage from the comparator controls the IF amplifiers. This adjusts the output power to a specified level from the [RF POWER] control until the FORV and POCV voltages are equalized.

In AM mode, the comparator operates as an averaging ALC amplifier. Q502 turns ON and the POCV voltage is shifted for 40 W AM output power (maximum) through R510.

• DSP Transmitter circuit

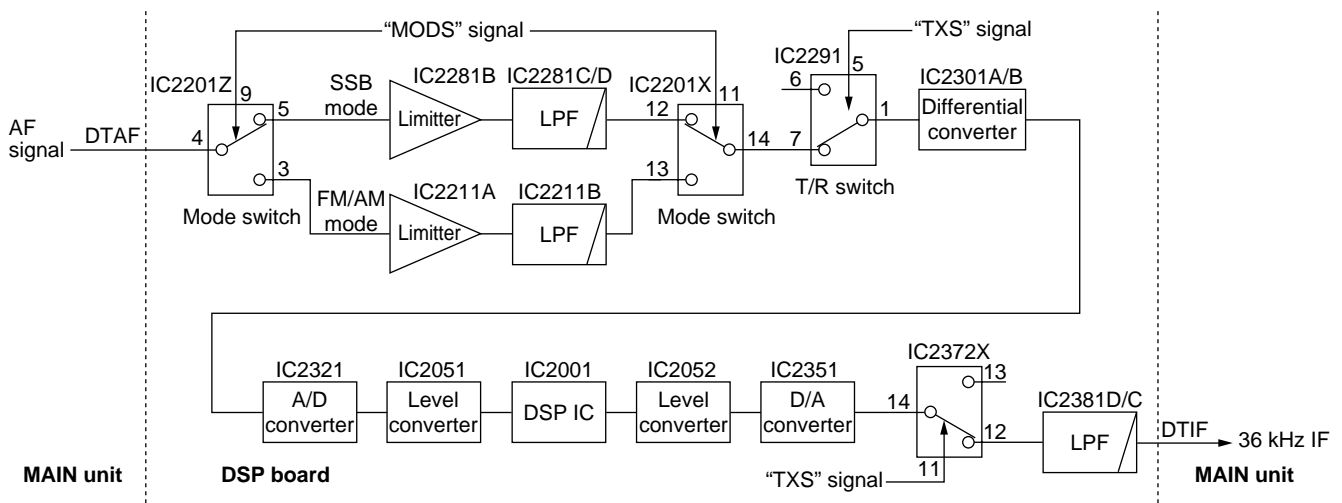

The ALC bias voltage is also applied to the ALC meter amplifier (IC551a, pin 2) to obtain an ALC meter signal (ALCL). The amplified signal is passed through the analog switch (IC3631, pins 13, 14) and applied to the main CPU (IC3501, pin 108) to drive the S/Rf meter via the sub CPU (IC401) on the DISPLAY board.

An external ALC input from the [ALC] jack or [ACC] sockets is applied to the buffer amplifier (Q521). External ALC operation is identical to that of the internal ALC.

The FORV signal is also applied to the power meter amplifier (IC571a, pin 3). The amplified signal is passed through the analog switch (IC3631, pins 1, 15) as an FORL signal and applied to the main CPU (IC3501, pin 109) to drive the S/Rf meter when the power meter is selected.

3-2-9 APC CIRCUIT (MAIN UNIT)

The APC (Automatic Power Control) circuit protects the power amplifiers on the PA unit from high SWR and excessive current.

The reflected wave signal appears and increases when the connected antenna is mismatched to 50 Ω. The APC detector circuit (CTRL unit; D1 and L1) detects the reflected signal, and applies it to the APC circuit (IC551c, pin 9) as a REFV signal.

When the REFV signal level increases, the APC circuit decreases the ALC voltage to activate the APC.

For the current APC, the power transistor current is obtained by detecting the voltages (ICH and ICL) which appear at both terminals of the current detector (PA unit, R28). The detected voltages are applied to the differential amplifier (IC551d, pins 12, 13). When the current of transistors is increased, the amplifier controls the ALC line to prevent excessive current flow.

A portion of the REFV signal is applied to the SWR meter amplifier (IC571b, pin 5). The amplified signal is passed through the analog switch (IC3631, pins 3, 4) as an REFL signal and applied to the main CPU (IC3501, pin 110) to drive the S/Rf meter when the SWR meter is selected.

3-2-10 TEMPERATURE PROTECTION CIRCUIT (PA UNIT)

The cooling fan (MF1) is activated while transmitting or when the temperature of the power amplifier exceeds the preset value. The temperature protection circuit consists of Q10–Q13 and R50.

While transmitting, Q10 and Q12 are turned ON, and provide a voltage to the cooling fan to rotate at medium speed. The thermistor detects the temperature of Q5, and activates Q11 and Q13 to accelerate the cooling fan when the detected temperature exceeds 70°C (158°F). The cooling fan rotates at high speed at 80°C (176°F) or more.

The thermistor keeps the cooling fan rotating even while receiving until the Q5 temperature drops to 60°C (140°F) or below.

3-2-11 MONITOR CIRCUIT (DSP BOARD AND MAIN UNIT)

The microphone audio signals can be monitored to check voice characteristics.

(1) When FM/AM modes (MAIN UNIT)

A portion of the microphone audio signals from the VCA section in IC451 are applied to the analog switch (IC361). The selected audio signals are applied to IC371 (pin 2), and the output signals from pin 9 are applied to the AF amplifier circuit (IC311, pin 7).

(2) When SSB/RTTY modes (DSP BOARD)

A portion of the transmit IF signal from the low-pass filter (IC2381c/d) is amplified at the IF (IC2381b) and buffer (IC2381a) amplifiers and applied to the digital mixer circuit (IC2302). The applied signal is mixed with a 36 kHz LO signal from IC2347 to demodulate into the AF signals. The demodulated signals are passed through the buffer amplifier (IC2381a), low-pass filter (IC2441b/c) and AF amplifier (IC2441d), and then applied to the MAIN unit as the DMAF signal.

The DMAF signal from the DSP board is amplified at ALC amplifier (MAIN unit; IC372) and applied to the VCA section of IC371 (MAIN unit). The volume controlled AF signals is applied to the AF amplifier circuit (MAIN unit; IC311, pin 7).

3-3 PLL CIRCUITS

3-3-1 GENERAL

The PLL unit generates a pair of 1st LO frequencies (64.485–124.455 MHz) for dualwatch and spectrum scope functions; a 2nd LO frequency (64 MHz), 3rd LO frequency (491 kHz) and sweep LO frequency for the spectrum scope function.

The 1st LO PLLs adopt a mixer-less dual loop PLL system and has 4 VCO circuits. The LOs, except the 2nd, use DDSs while the 2nd LO uses the fixed frequency of the crystal oscillator.

3-3-2 1ST LO PLL CIRCUIT

The 1st LO PLLs contain a main and reference loop as a dual loop system. Both PLLs have equivalent circuits— this manual describes only the 1st LO PLL A circuit.

The reference loop generates a 10.747 to 10.865 MHz frequency using a DDS circuit, and the main loop generates a 64.485 to 124.455 MHz frequency using the reference loop frequency.

(1) REFERENCE LOOP PLL

The oscillated signal at the reference VCO (Q151, D151) is amplified at the amplifiers (Q152, Q102) and is then applied to the DDS IC (IC101, pin 46). The signal is then divided and detected on phase with the DDS generated frequency.

The detected signal output from the DDS IC (pin 56) is converted into DC voltage (lock voltage) at the loop filter (R135–R137, C121, C151) and then fed back to the reference VCO circuit (Q151, D151).

(2) MAIN LOOP PLL

The oscillated signal at one of the main loop VCOs (Q201, D201, D202), (Q221, D221, D222), (Q251, D251–D254) and (Q271, D271–D274) is amplified at the buffer amplifiers (Q301, IC320) and is then applied to the PLL IC (IC381, pin 6). The signal is then divided and detected on phase with the reference loop output frequency.

The detected signal output from the PLL IC (pin 2) is converted into a DC voltage (lock voltage) at the loop filter and then fed back to one of the VCO circuits (Q201, D201, D202), (Q221, D221, D222), (Q251, D251–D254) and (Q271, D271–D274).

The oscillated signal is amplified at the buffer amplifiers (Q301, IC320) and then applied to the RF unit as a 1st LO A signal after being passed through the bandpass filter (L303, L351–L354, C304–C307, C351–C356, C358–C360).

3-3-3 2ND LO AND REFERENCE OSCILLATOR CIRCUITS

The reference oscillator (X52, Q51) generates a 32.00056 MHz frequency for the 4 DDS circuits as a system clock and for the LO output. The oscillated signal is doubled at the doubler circuit (Q71, Q81) and the 64.0 MHz frequency is picked up at the double tuned filter (L81, L82). The 64.0 MHz signal is applied to the RF unit as a 2nd LO signal.

• PLL CIRCUIT

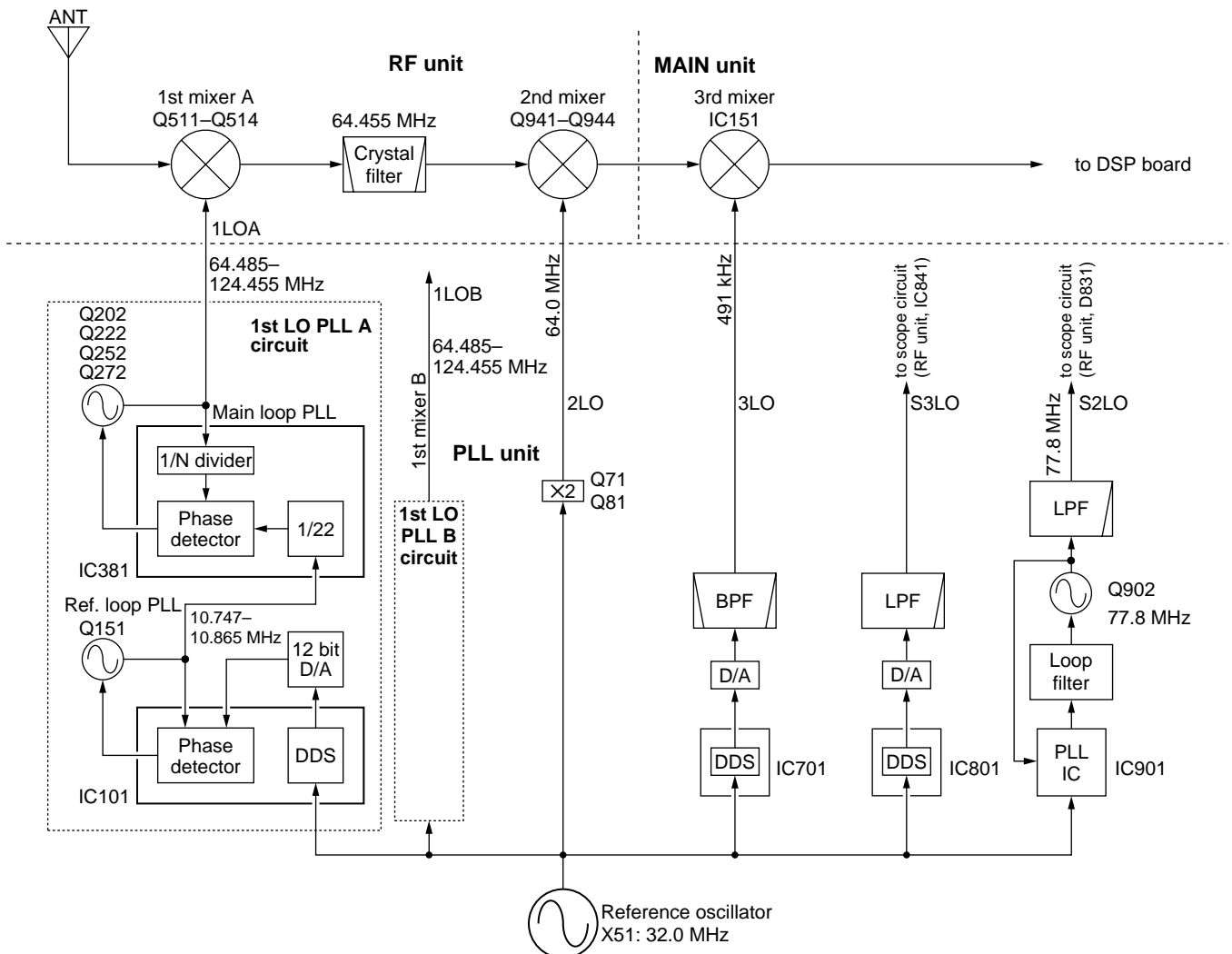

3-3-4 3RD LO CIRCUIT

The DDS IC (IC701) generates a 10-bit digital signal using the 32 MHz system clock. The digital signal is converted into an analog wave signal at the D/A converter (R701–R720). The converted analog wave is passed through the bandpass filter (L702, L703, C709–C713) and then applied to the MAIN unit as the 3rd LO signal.

3-3-5 MARKER CIRCUIT

The divided signal at the DDS circuit (IC101) is used for the marker signals with the IC-756PRO.

The reference signal for the DDS circuit (32.0 MHz) is divided to produce an acceptable frequency signal, 16 MHz, with the programmable divider then divided again by 160 to obtain 100 kHz cycle square-wave signals.

The generated marker signals are output from pin 66 of the DDS IC (IC101), and are then applied to the RF unit via the mute switch (IC192) and J851 as the MKR signal.

3-4 ANTENNA TUNER CIRCUITS

3-4-1 MATCHING CIRCUIT (TUNER UNIT)

The matching circuit is a T-network. Using 2 tuning motors, the matching circuit obtains rapid overall tuning speed.

Using relays (RL1–RL15), the relay control signals from the antenna tuner CPU (CTRL unit; IC5) via the buffer-amplifier (IC1, IC2) ground one of the taps of L3–L12 and add capacitors (C27–C43). After selecting the coils and capacitors, 2 motors (CTRL unit; MF1, MF2) adjust C44 and C45 using the antenna tuner CPU (CTRL unit; IC5) and the motor controller (CTRL unit; Q211–Q218, D211–D217) to obtain a low SWR (Standing Wave Ratio).

3-4-2 DETECTOR CIRCUIT (CTRL UNIT)

(1) SWR detector

Forward and reflected power are picked up by a current transformer (L1), detected by D2 and D1, and then amplified at IC1a and IC1b, respectively. The amplified voltages are applied to the antenna tuner CPU (IC5, pins 2, 3). The tuner CPU detects the SWR.

(2) Reactance components detector

Reactance components are picked up by comparing the phases of the RF current and RF voltage. The RF current is detected by L4 and R16 and buffer-amplified at IC14e and IC2a and then applied to the phase comparator (IC3a). RF voltages are detected by C12–C14 and then applied to the phase comparator (IC3b) after being amplified at the buffer-amplifiers (IC14c, IC2b). The output signal from the phase comparator (IC3a, pin 6 for RF current, IC3b pin 7 for RF voltage) is rectified at D7 and D6 for conversion into DC voltage. The rectified voltage signals are combined, then amplified at the inverter amplifier (IC4b), then applied to the antenna tuner CPU (IC5, pin 64).

A C-MOS IC is used for the buffer-amplifier (IC14) to improve functional sensitivity; the inverter amplifier (IC4) is very responsive even with a low signal level input. Together, these ensure quick and stable signal detection even at low RF signal level input.

(3) Resistance components detector

Resistance components are picked up by L8, and detected by D8, D9 and Q5. The detected resistance components are amplified at the inverter amplifier (IC4a), and then applied to the antenna tuner CPU (IC5, pin 1).

3-4-3 MOTOR CONTROL CIRCUIT (CTRL AND TUNER UNITS)

The control circuit of the internal antenna tuner consists of the CPU, EEPROM*, tuning motors and tuning relays.

*Electronically-Erasable Programmable Read Only Memory

(1) CPU and EEPROM (CTRL unit)

The antenna tuner CPU (IC5) controls the tuning motors via the motor controller (Q211–Q218, D211–D217) and tuning relays, and memorizes the best preset position in 100 kHz steps. The memory contents are stored in the EEPROM (IC6) without a backup battery.

(2) Tuning motors (CTRL and TUNER units)

A motor controller (Q211–Q218, D211–D217) rotates the tuning motors (TUNER unit; MF1, MF2) to obtain a low SWR.

(3) Tuning relays (TUNER unit)

According to the operating frequency band and antenna condition, tuning relays select the capacitors and coils.

3-4-4 ANTENNA TUNER CPU PORT ALLOCATION (CTRL unit; IC5)

Pin number	Port name	Description
1	R	Input port for the resistance components detection voltage.
2	REF	Input port for the reflected RF power voltage.
3	FOR	Input port for the forward RF power voltage.
4	PWRS	Input port for the transceiver power OFF.
6	STDU	Inputs low level signal when operating the antenna tuner in 50 MHz band.
7	SETI	Input port for reference voltage setting.
13	KEY	Outputs tuner data signal.
15	START	Input port for the serial signal.
17	THRU	Input port for the [TUNER] ON/OFF signal.
21	SEND	Input port for the TX/RX switching signal.
22, 23	CL1, CL2	Input port for the antenna tuner CPU system clock.
26	DUAL	Outputs the coil selection signal. High : While 46–60 MHz band is displayed.
27–32	L24M, L18M, L14M, L10M, L7M, L3.5M	Output the coil selection signal.
34–40	CO3, CO2, CO1, CI3, CI2, CI1	Output the capacitor selection signal.
41–48	PZ, PY, PX, PW, RZ, RY, RX, RW	Output pulse-type control signals for the tuning motors (M1, M2).
64	P	Input port for the reactance components detection voltage.

3-5 SCOPE CIRCUITS

3-5-1 SCOPE RECEIVER CIRCUIT (RF UNIT)

A portion of the 64.455 MHz 1st IF signal from the 1st mixer circuit (Q511–Q514: while receiving) or IF amplifier (Q751: while transmitting) is amplified at the IF amplifiers (Q811, Q812), then mixed with the 77.8 MHz scope 2nd LO signal at the mixer circuit (D831) to produce the 13.345 MHz IF signal. The mixed IF signal is passed through the ceramic bandpass filters (F1843, F1841) to suppress unwanted signals. The filtered IF signal is applied to the FM IF IC (IC841, pin 16).

The applied 13 MHz IF signal is mixed with the sweep LO signals from the PLL unit at the FM IF IC (IC841), which includes the RSSI terminal. The mixed IF signals are filtered at the ceramic bandpass filter (F1842) then applied to the limiter amplifier section in the FM IF IC (IC841, pin 5). The applied IF signals are converted into DC voltages according to the applied IF signal strength at the RSSI section in the IC.

The converted voltages are amplified at IC871b then applied to the MAIN unit as the SCPL signal.

Some of the DC voltages from the FM IF IC are amplified at IC871a to produce AGC voltages for the IF amplifiers (Q811, Q812), producing wider dynamic range.

By sweeping LO signals (S3LO) are applied to the mixer section in the FM IF IC, the spectrum scope function is activated.

3-5-2 SWEEP LO CIRCUIT (PLL UNIT)

The sweep LO signals (S3LO) are generated by the DDS IC (IC801) using the 32 MHz system clock. A 10-bit digital signal is converted into analog wave signals at the D/A converter (R801–R820). The converted analog wave is passed through the bandpass filter (L802, L803, C809–C813) then applied to the RF unit after being amplified at the buffer amplifier (Q802).

• SCOPE CIRCUIT DIAGRAM

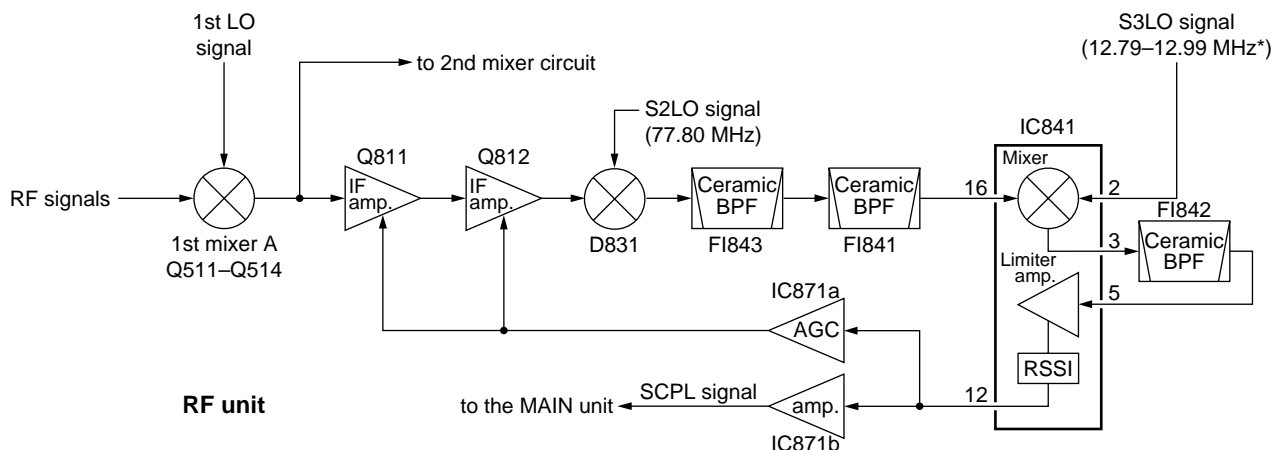

*depending on sweeping passband width

3-6 POWER SUPPLY CIRCUITS

3-6-1 PA UNIT

LINE	DESCRIPTION
PHV	The voltage from an external power supply via the common filter circuit (FILTER unit, L501, L502).
HV	The same voltage as the PHV line passed through a fuse (F1).
14 V	The same voltage as the HV line passed through the switching relay (RL1).
14 VA	The same voltage as the 14 V line is applied to the AF power amplifier (MAIN unit, IC332).
8 V	Common 8 V converted from the 14 V line and regulated by the +8 regulator circuit (IC3).
5 V	Common 5 V converted from the 14 V line and regulated by the +5 regulator circuit (IC2).
H5V	Common 5 V converted from the 14 V line and regulated by the H5V regulator circuit (IC1).

3-6-2 FRONT UNIT

LINE	DESCRIPTION
5V	Common 5 V converted from the 14 V line and regulated by the +5 regulator circuit (IC861).
-15V	Common -15 V converted from the 14 V line and converted by the -15 DC-DC converter circuit (IC841, Q841, D841). The voltage is applied to the -7 V, -8 V regulator circuits and etc.
-7V	Common -7 V converted from the 14 V line and regulated by the -7 regulator circuit (IC501).
-8V	Common -8 V converted from the 14 V line and regulated by the -8V regulator circuit (IC881).
+18V	Common 18 V converted from the 14 V line and converted by the 18 V DC-DC converter circuit (IC821, Q821, D822).

3-6-3 MAIN UNIT

LINE	DESCRIPTION
R8V	Receive 8 V converted from the 14 V line and regulated by the R8V regulator circuit (Q601, Q602, D601).
T8V	Transmit 8 V converted from the 14 V line and regulated by the T8V regulator circuit (Q611, Q612, D611).

3-6-4 CTRL AND PLL UNITS

LINE	DESCRIPTION
5V	Common 5 V for the antenna tuner CPU (CTRL unit; IC5) and the EEPROM (CTRL unit; IC6), converted from the 14 V line and regulated by the +5 regulator circuit (CTRL unit; IC13).
5V	Common 5 V for each of the PLL-A and PLL-B circuits regulated from the 8 V line and regulated by the +5 regulator circuit (PLL unit; IC382: PLL-A, IC682: PLL-B).

3-7 LOGIC CIRCUITS

3-7-1 BAND SELECTION DATA (RF, CTRL AND PLL UNITS)

To select the correct bandpass, low-pass filters and VCOs on the RF, FILTER and PLL units, the main CPU (MAIN unit, IC3501) outputs the following band selection data via the I/O expander (RF unit, IC901, IC902, CTRL unit, IC11) or DDS IC (PLL unit, IC101, IC401) depending on the displayed frequency.

Frequency [MHz]	IC901, IC902 (RF unit)	IC11 (CTRL)	IC101 (PLL)	IC401 (PLL)
	BPF	LPF	VCO-A	VCO-B
0.003–1.599999	B0	L1S	VA1S	VB1S
1.6–1.999999	B1			
2.0–2.999999	B2	L2S		
3.0–3.999999	B3			
4.0–5.999999	B4			
6.0–7.999999	B5	L3S		
8.0–10.999999	B6	L4S	VA2S	VB2S
11.0–14.999999	B7			
15.0–19.999999	B8	L5S		
20.0–21.999999				
22.0–29.999999	B9	L6S	VA3S	VB3S
30.0–44.999999	B10W	L7	VA4S	VB4S
45.0–49.999999				
50.0–54.000000	B10			
54.000001– 60.000000	B10W			

The D/A convertor (MAIN unit, IC3751) output signal from pin 7 is amplified at IC101b (pins 5–7) to obtain the band voltage for external equipment via the [ACC 2] connector pin 4.

SECTION 4 ADJUSTMENT PROCEDURES

4-1 PREPARATION BEFORE SARVICING

■ REQUIRED TEST EQUIPMENT

EQUIPMENT	GREDE AND RANGE	EQUIPMENT	GREDE AND RENGE
DC power supply	Output voltage : 13.8 V DC Current capacity : 30 A or more	Audio generator	Frequency range : 300–3000 Hz Measuring range : 1–500 mV
RF power meter (terminated type)	Measuring range : 10–200 W Frequency range : 1.8–100 MHz Impedance : 50 Ω SWR : Less than 1.2 : 1	Standard signal generator (SSG)	Frequency range : 0.1–100 MHz Output level : 0.1 μV–32 mV (–127 to –17 dBm)
Frequency counter	Frequency range : 0.1–100 MHz Frequency accuracy : ±0.5 ppm or better Sensitivity : 100 mV or better	Digital multimeter	Imput impedance : 10 MΩ/DC or beter
RF voltmeter	Frequency range : 0.1–100 MHz Measuring range : 0.01–10 V	AC millivoltmeter	Measuring range : 10 mV–10 V
FM deviation meter	Frequency range : DC–500 MHz Measuring range : 0 to ±5 kHz	DC voltmeter	Input impedance : 50 kΩ/V DC or better
Modulation analyzer	Frequency range : At least 90 MHz Measuring range : 0–100 %	DC ammeter	Measurement capability: 1 A/30 A
Distortion meter	Frequency range : 1 kHz ±10 % Measuring range : 1–100 %	Spectram analyzer	Frequency range : At least 90 MHz Spectraum bandwidth : 100 kHz or more
Oscilloscope	Frequency range : DC–20 MHz Measuring range : 0.01–20 V	Attenuator	Power attenuation : 50 or 60 dB Capacity : 150 W or more
		External speaker	Input impedance : 8 Ω Capacity : 5 W or more
		Terminator	Resistance : 50 and 150 Ω Capacity : 150 W or more

■ CONNECTIONS

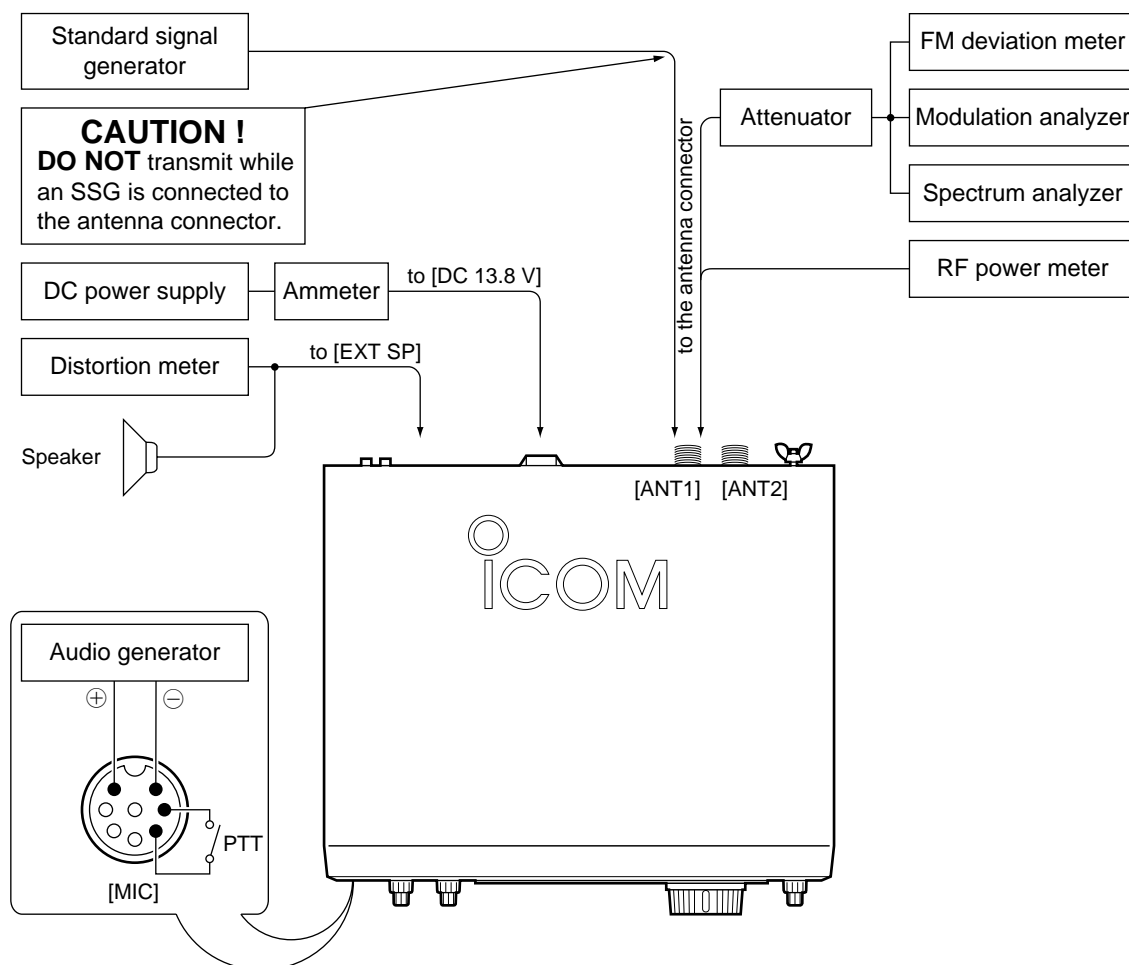

4-2 PLL ADJUSTMENTS

ADJUSTMENT	ADJUSTMENT CONDITION	MEASUREMENT		VALUE	ADJUSTMENT POINT		
		UNIT	LOCATION		UNIT	ADJUST	
REFERENCE FREQUENCY	1	<ul style="list-style-type: none"> • Display frequency: Any • Turn L52 on the PLL unit to 4 rotation downside for presetting. 	PLL	Connect a frequency counter to check point P81.	64.000000 MHz	PLL	L52 (R33 for critical adjustment)
	2						<ul style="list-style-type: none"> • Receiving
LPL-A LOCK VOLTAGE	1	<ul style="list-style-type: none"> • Display frequency: 0.030000 MHz • Mode : USB • Receiving 	PLL	Connect a digital multimeter or oscilloscope to check point LPA.	2.0 V	PLL	C154
VCO-A LOCK VOLTAGE	1	<ul style="list-style-type: none"> • Display frequency: 14.999999 MHz • Mode : USB • Receiving 	PLL	Connect a digital multimeter or oscilloscope to check point LVA.	4.3 V	PLL	C278
	2	<ul style="list-style-type: none"> • Display frequency: 19.999999 MHz • Mode : USB • Receiving 			4.3 V		C258
	3	<ul style="list-style-type: none"> • Display frequency: 44.999999 MHz • Mode : USB • Receiving 			4.3 V		C228
	4	<ul style="list-style-type: none"> • Display frequency: 60.000000 MHz • Mode : USB • Receiving 			4.3 V		C208
1LO-A OUTPUT LEVEL	1	<ul style="list-style-type: none"> • Display frequency: 0.030000 MHz, 7.999999 MHz, 8.000000 MHz, 19.999999 MHz, 20.000000 MHz, 44.999999 MHz, 45.000000 MHz, 60.000000 MHz • Receiving 	PLL	Connect an RF voltmeter to check point P351.	0 dBm or more		Verify
LPL-B LOCK VOLTAGE	1	<ul style="list-style-type: none"> • Sub display freq. : 0.030000 MHz • Mode : USB • Receiving 	PLL	Connect a digital multimeter or oscilloscope to check point LPB.	2.0 V	PLL	C454
VCO-B LOCK VOLTAGE	1	<ul style="list-style-type: none"> • Sub display freq. : 7.999999 MHz • Mode : USB • Receiving 	PLL	Connect a digital multimeter or oscilloscope to check point LVB.	4.3 V	PLL	C578
	2	<ul style="list-style-type: none"> • Sub display freq. : 19.999999 MHz • Mode : USB • Receiving 			4.3 V		C558
	3	<ul style="list-style-type: none"> • Display frequency: 44.999999 MHz • Mode : USB • Receiving 			4.3 V		C528
	4	<ul style="list-style-type: none"> • Display frequency: 60.000000 MHz • Mode : USB • Receiving 			4.3 V		C508
1LO-B OUTPUT LEVEL	1	<ul style="list-style-type: none"> • Sub display freq. : 0.030000 MHz, 7.999999 MHz, 8.000000 MHz, 19.999999 MHz, 20.000000 MHz, 44.999999 MHz, 45.000000 MHz, 60.000000 MHz • Receiving 	PLL	Connect an RF voltmeter to check point P651.	0 dBm or more		Verify
3LO OUTPUT LEVEL	1	<ul style="list-style-type: none"> • Display frequency: Any • Receiving 	PLL	Connect an RF voltmeter to check point P701.	-16 dBm or more		Verify
S3LO OUTPUT LEVEL	1	<ul style="list-style-type: none"> • Display frequency: Any • Receiving 	PLL	Connect an RF voltmeter to check point P801.	-7 dBm or more		Verify

PLL ADJUSTMENTS—continued

ADJUSTMENT	ADJUSTMENT CONDITION	MEASUREMENT		VALUE	ADJUSTMENT POINT	
		UNIT	LOCATION		UNIT	ADJUST
S2LO OUTPUT LEVEL	1 • Display frequency: Any • Receiving	PLL	Connect an RF voltmeter to check point P901.	0 dBm or more		Verify
MARKER OUTPUT LEVEL	1 • Display frequency: Any • Receiving	PLL	Connect an oscilloscope to check point P851.	4 Vp-p or more		Verify

• PLL unit

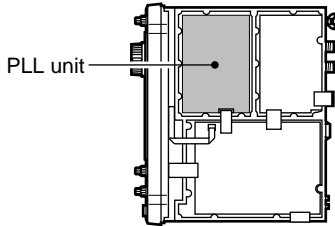

Bottom view of the transceiver

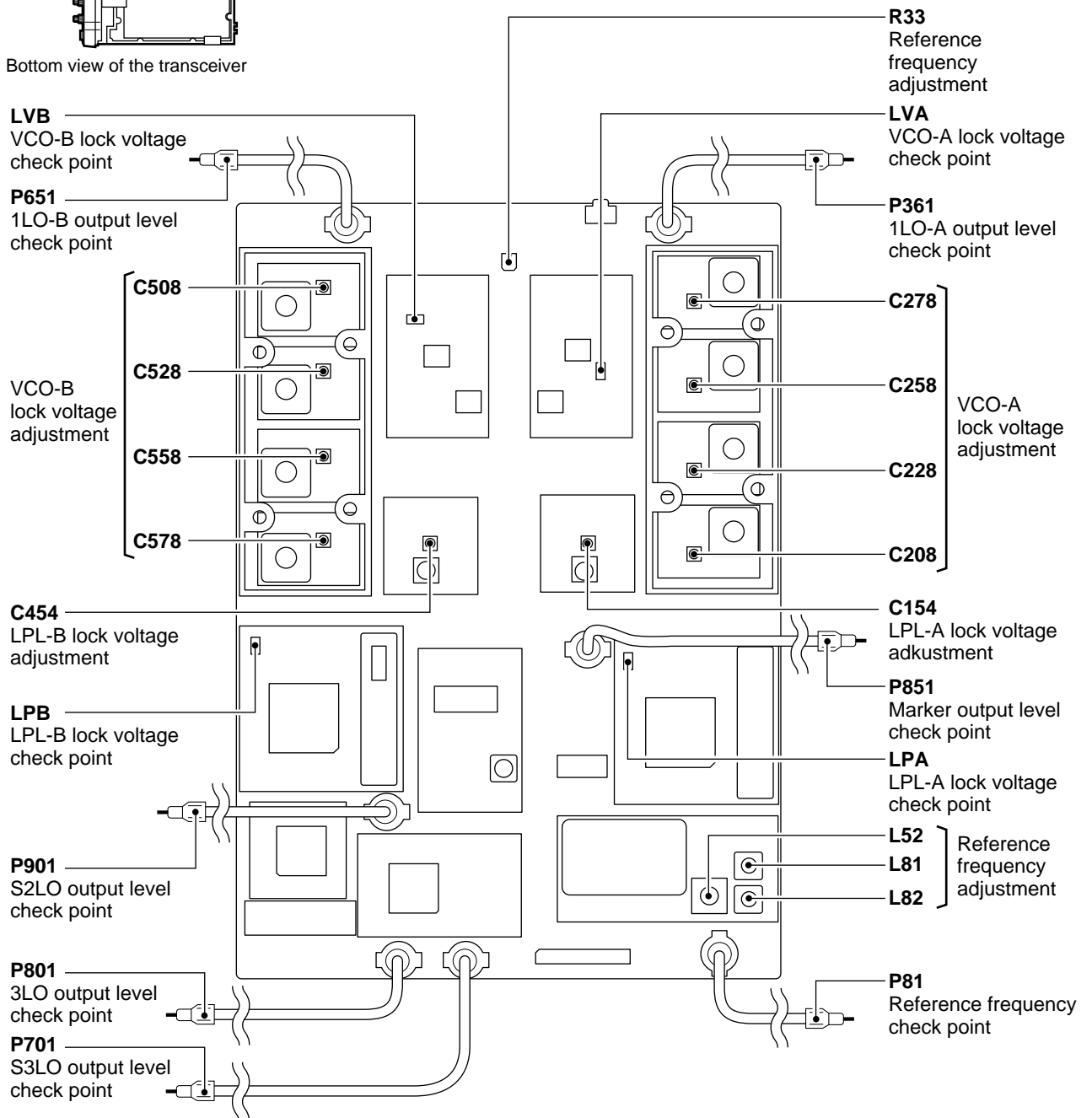

4-3 RECEIVER ADJUSTMENTS

ADJUSTMENT	ADJUSTMENT CONDITION	MEASUREMENT		VALUE	ADJUSTMENT POINT		
		UNIT	LOCATION		UNIT	ADJUST	
RX PEAK	1	<ul style="list-style-type: none"> • Display frequency: 14.100000 MHz • Mode : USB • Filter : 2.4 kHz • [P.AMP] : P.AMP1 • [ATT] : OFF • Connect an SSG to [ANT1] connector and set as : Frequency : 14.101500 MHz Level : 10 μV* (-87 dBm) Modulation: 1 kHz/\pm7.5 kHz dev. • Receiving 	Rear panel	Connect an AC millivolt meter to [EXT SP] connector with an 8 Ω load.	Maximum audio output level	RF	L513, L721, L722, L943
	2	<ul style="list-style-type: none"> • [DUAL WATCH] : ON • Sub display freq. : 14.100000 MHz • Mode : USB • [BAL] : Max. CW • Set an SSG as : Level : 10 μV* (-87 dBm) • Receiving 					L613
	3	<ul style="list-style-type: none"> • Display frequency: 14.100000 MHz • Mode : USB • [DUAL WATCH] : OFF • Set following selections, controls and functions as : Filter : 2.4 kHz, [ATT] : OFF [AGC]: MID , [BAL] : Center PBT1 : Center , PBT2 : Center [NB] : OFF , [RIT] : OFF [P.AMP] : P.AMP1 [RF/SQ] : Center [AUTO NOTCH]: OFF [NOTCH] : Center [NR] switch : OFF [NR] level : Max. CCW [MONITOR] : OFF • Connect an SSG to [ANT1] connector and set as : Frequency : 14.101500 MHz Level : 1 μV* (-107 dBm) Modulation: OFF • Receiving 				MAIN	L111, L112, L113
MIXER BALANCE	1	<ul style="list-style-type: none"> • Display frequency: 0.030000 MHz • Sub display freq. : 0.030000 MHz • Mode : USB • [BAL] : Max. CCW • Apply no no RF signal to [ANT1] connector. • Receiving 	Rear panel	Connect an AC millivolt meter to [EXT SP] connector with an 8 Ω load.	Minimum noise output level	RF	R516
	2	<ul style="list-style-type: none"> • [BAL] : Max. CW • Receiving 					R616
FM DISTORTION	1	<ul style="list-style-type: none"> • Display frequency: 14.100000 MHz • Sub display freq. : 14.100000 MHz • Mode : FM • [BAL] : Max. CCW • Connect an SSG to [ANT1] connector and set as : Frequency : 14.100000 MHz Level : 500 μV* (-53 dBm) Modulation: 1 kHz/\pm7.5 kHz Dev. • Receiving 	Rear panel	Connect an distortion meter to [EXT SP] connector with an 8 Ω load.	Minimum distortion level	RF	C555
	2	<ul style="list-style-type: none"> • [BAL] : Max. CW • Receiving 					C655

*This output level of a standard signal generator (SSG) is indicated as SSG's open circuit.

• **RF unit**

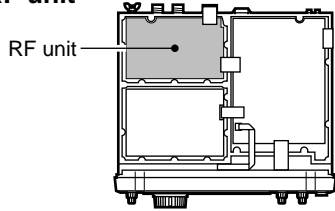

Bottom view of the transceiver

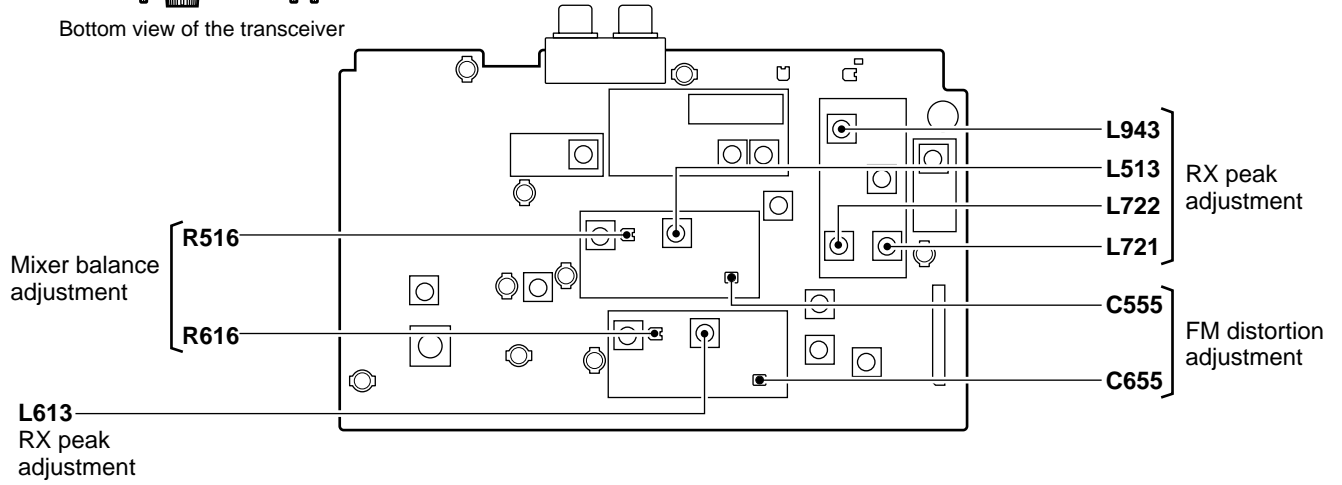

• **MAIN unit**

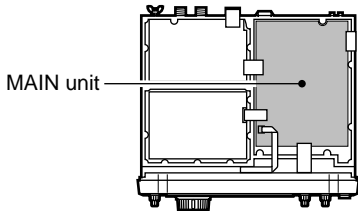

Bottom view of the transceiver

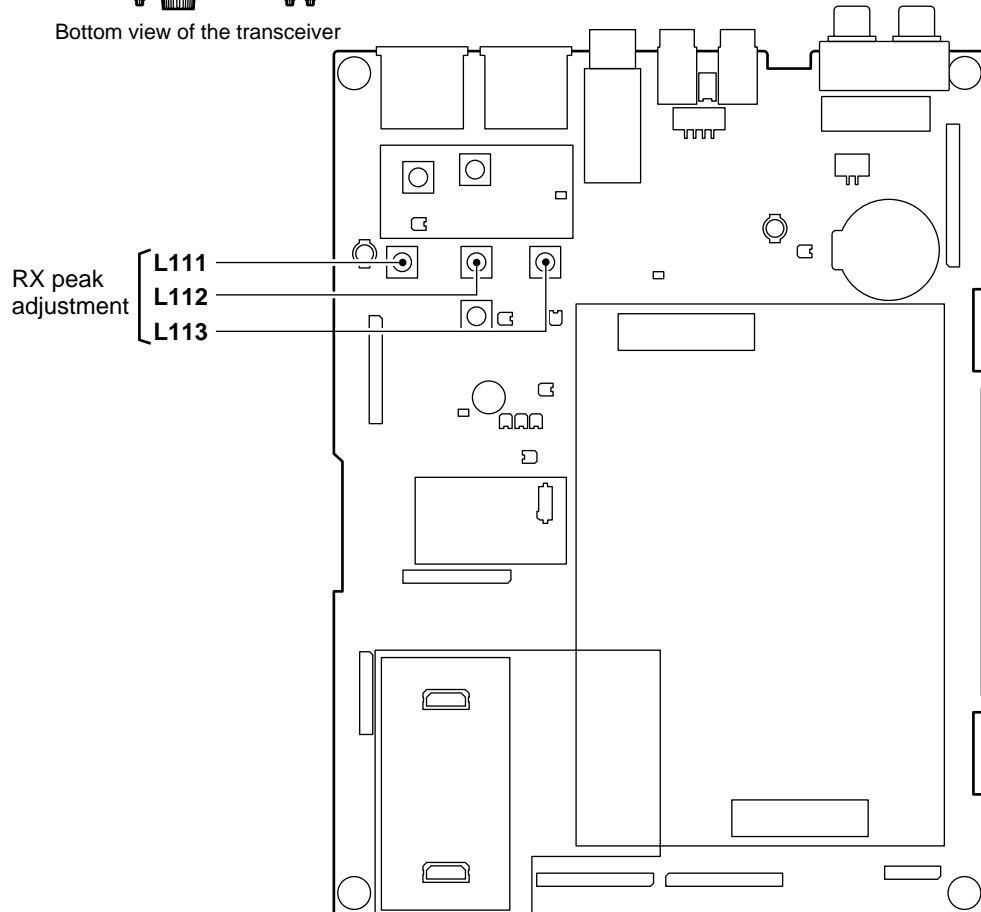

RECEIVER ADJUSTMENTS—continued

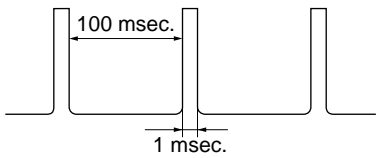
ADJUSTMENT	ADJUSTMENT CONDITION	MEASUREMENT		VALUE	ADJUSTMENT POINT			
		UNIT	LOCATION		UNIT	ADJUST		
RECEIVER TOTAL GAIN	1 <ul style="list-style-type: none"> • Display frequency: 14.100000 MHz • Mode : USB • Filter : 2.4 kHz • [P.AMP] : OFF • Connect an SSG to [ANT1] connector and set as : <ul style="list-style-type: none"> Frequency : 14.101500 MHz Level : 500 μV* (-53 dBm) Modulation: OFF • Receiving 	Rear panel	Connect an AC millivolt meter to [EXT SP] connector with an 8 Ω load.	1.0 V (0 dB)	Front unit	[AF] control		
	2 <ul style="list-style-type: none"> • Set an SSG output level to OFF. • Receiving 						32 mV (-30 dB)	MAIN
NOISE BLANKER	1 <ul style="list-style-type: none"> • Display frequency: 14.100000 MHz • Mode : USB • [P.AMP] : P.AMP1 • [NB] : OFF • Connect an SSG to [ANT1] connector and set as : <ul style="list-style-type: none"> Frequency : 14.101500 MHz Level : 10 μV* (-87 dBm) Modulation: OFF and apply following signal to [ANT1] connector.  <ul style="list-style-type: none"> • Preset R271 on the MAIN unit to the 12 o'clock position. • Receiving 	MAIN	Connect an oscilloscope to check point CP271.	Maximum noise level	MAIN	L271, L272		
	2 <ul style="list-style-type: none"> • [NB] : ON • Receiving 						At the point where the voltage just reduces.	R271
SPECTRUM SCOPE	1 <ul style="list-style-type: none"> • Display frequency: 14.100000 MHz • Mode : USB • [DUAL WATCH] : OFF • [P.AMP] : OFF • [SCOPE] : ON • [SCOPE ATT] : OFF • Verify the connection of J841 on the RF unit and P801 (S3LO: 12.89000 MHz/-7 dBm) from the PLL unit. • Connect an SSG to [ANT1] connector and set as : <ul style="list-style-type: none"> Frequency : 14.101500 MHz Level : 1 μV* (-107 dBm) Modulation: OFF • Receiving 	RF	Connect a digital multimeter or oscilloscope to check point CP871.	Muximum voltage	RF	L812, L813, L833		
	2 <ul style="list-style-type: none"> • Set an SSG output level to OFF. • Receiving 						0.05 V-0.15 V	R872
	3 <ul style="list-style-type: none"> • Set an SSG output level as: <ul style="list-style-type: none"> Level : 50 mV* (-13 dBm) • Receiving 						4.35 V- 4.45 V	R863

*This output level of a standard signal generator (SSG) is indicated as SSG's open circuit.

• MAIN unit

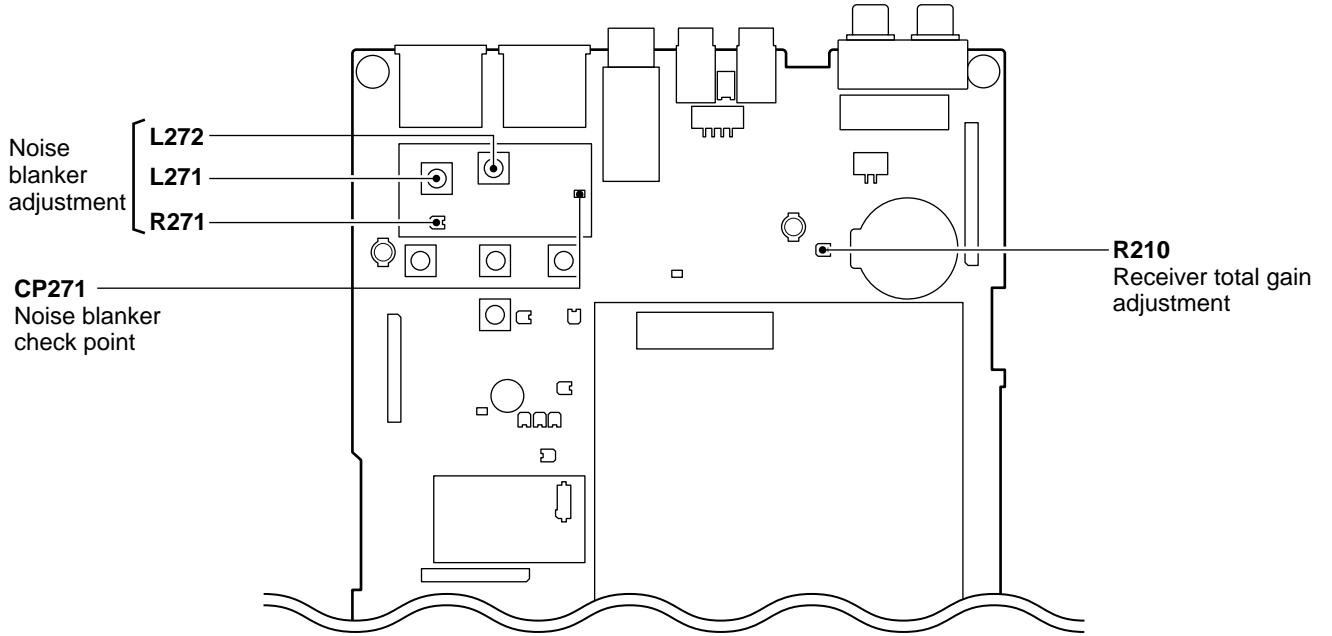
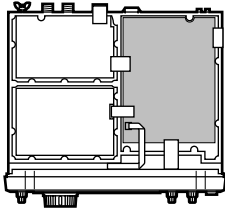

• RF unit

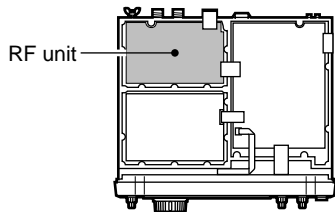

RF unit

Bottom view of the transceiver

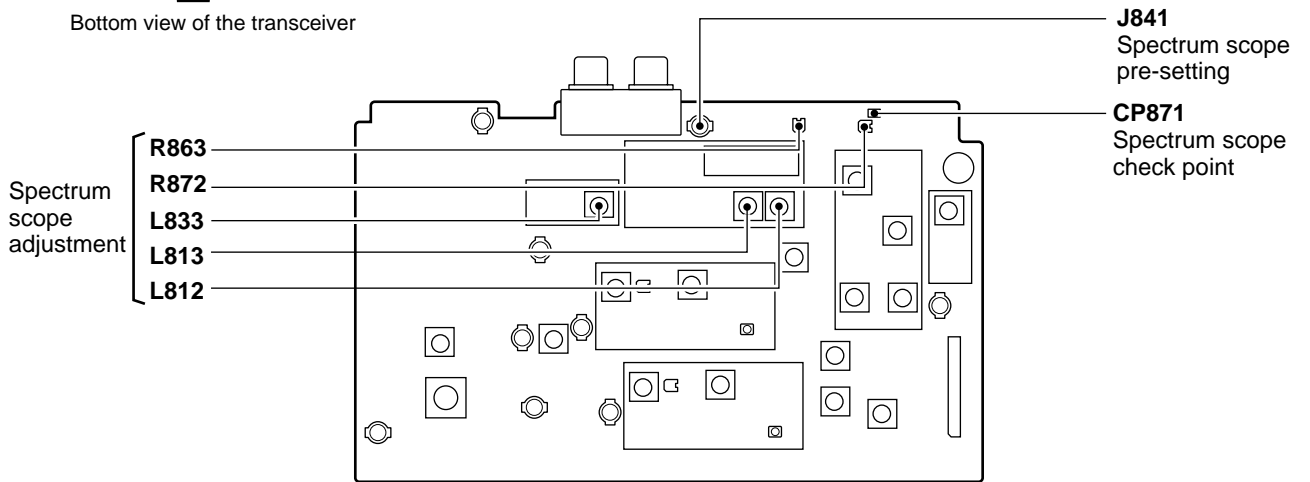

4-4 TRANSMITTER ADJUSTMENTS

ADJUSTMENT	ADJUSTMENT CONDITION	MEASUREMENT		VALUE	ADJUSTMENT POINT		
		UNIT	LOCATION		UNIT	ADJUST	
IDLING CURRENT (for driver)	1	<ul style="list-style-type: none"> • Display frequency: 14.100000 MHz • Mode : CW (key up) • Preset R11, R18 on the PA unit to max. CCW. • [RF POWER] : Max. CW • [TUNER] : OFF • Transmitting (without key) 	PA	Unsolder W29. Connect an ammeter to the unsoldering points of W29.	100 mA	PA	R11
	After adjustment, re-solder the lead wire (W29) on the PA board.						
(for final amplifier)	2	<ul style="list-style-type: none"> • Transmitting (without key) 	PA	Unsolder R28 (L8 side). Connect an ammeter to the unsoldering points of R28.	500 mA	PA	R18
	After adjustment, re-solder the resistor (R28) on the PA board.						
TX PEAK	1	<ul style="list-style-type: none"> • Display frequency: 14.100000 MHz • Mode : USB • [RF POWER] : Max. CW • Apply no audio signals to [MIC] connector. • Transmitting 	MAIN	Connect a digital multimeter or oscilloscope to check point CP243.	0.13 V	MAIN	R247
	2	<ul style="list-style-type: none"> • Connect an audio generator to [MIC] connector and set as: Frequency : 1.5 kHz Level : 1 mVrms • Transmitting 	Rear panel	Connect an RF power meter to [ANT1] connector.	50 W	Front panel	[MIC GAIN] control
	3	<ul style="list-style-type: none"> • Transmitting 			Maximum output power	MAIN	L261
	4	<ul style="list-style-type: none"> • Transmitting 	RF	Connect an RF voltmeter to check point J151.	Maximum level	RF	L752
TRANSMITTER TOTAL GAIN	1	<ul style="list-style-type: none"> • Display frequency: 14.100000 MHz • Mode : USB • [MIC GAIN] : Center • Connect an audio generator to [MIC] connector and set as: Frequency : 1.5 kHz Level : 1 mVrms • Transmitting 	Rear panel	Connect an RF power meter to [ANT1] connector.	50 W	MAIN	R263
Ic APC	1	<ul style="list-style-type: none"> • Display frequency: 3.550000 MHz • Mode : RTTY • Connect CP501 to GND. • Transmitting 	Rear panel	Connect an ammeter between power supply and the IC-756PRO.	23 A	MAIN	R545
HF BANDS OUTPUT POWER	1	<ul style="list-style-type: none"> • Display frequency: 14.100000 MHz • Mode : RTTY • [RF POWER] : Max. CW • [TUNER] : OFF • Transmitting 	Rear panel	Connect an RF power meter to [ANT1] connector.	100 W	MAIN	R507
50 MHz BAND OUTPUT POWER	1	<ul style="list-style-type: none"> • Display frequency: 51.000000 MHz • Mode : RTTY • [RF POWER] : Max. CW • [TUNER] : OFF • Transmitting 	Rear panel	Connect an RF power meter to [ANT1] connector.	100 W	MAIN	R509
AM CARRIER	1	<ul style="list-style-type: none"> • Display frequency: 29.60000 MHz • Mode : AM • [RF POWER] : Max. CW • [MIC GAIN] : Center • Apply no audio signals to [MIC] connector. • Transmitting 	MAIN	Connect an RF power meter to [ANT1] connector.	40 W	MAIN	R510

• PA unit

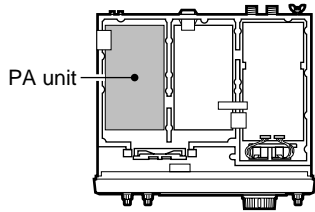

Top view of the transceiver

- W29**
Idling current check point
for drivers
- R18**
Idling current adjustment
for finals
- R11**
Idling current adjustment
for drivers
- R28**
Idling current check point
for finals

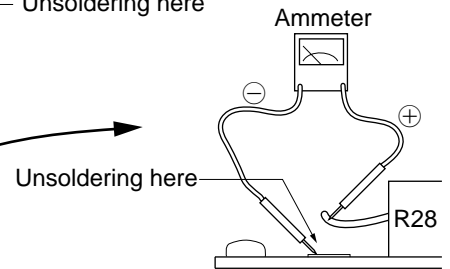
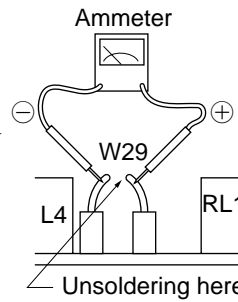
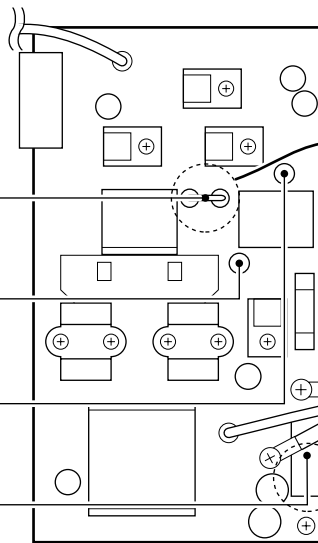

• RF unit

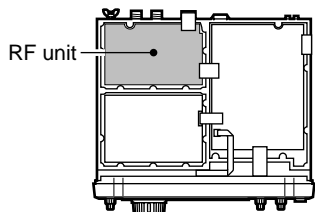

Bottom view of the transceiver

- J151**
TX peak check point

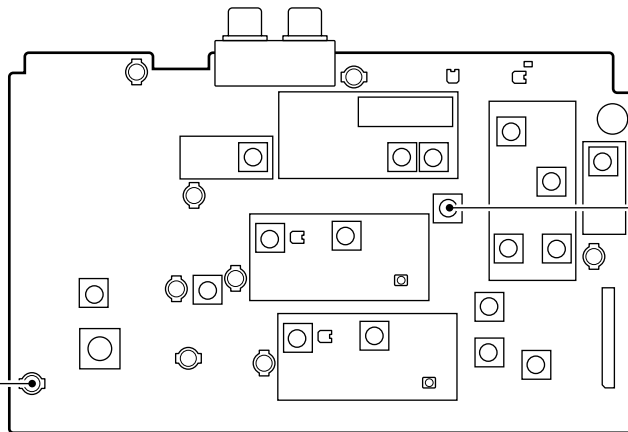

- L307**
TX peak
adjustment

• MAIN unit

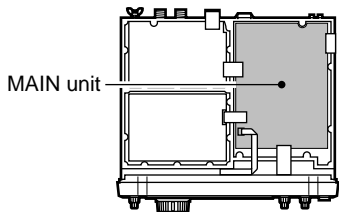

Bottom view of the transceiver

- L261**
TX peak
adjustment
- R509**
50 MHz band output power
adjustment
- R507**
HF bands output power
adjustment
- R545**
Ic APC adjustment

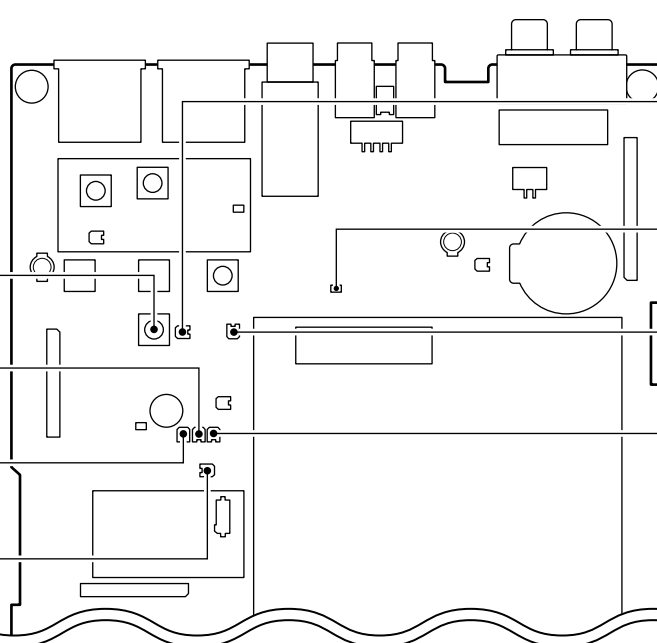

- R263**
Transmitter
total gain
adjustment
- CP243**
TX peak
check point
- R247**
TX peak
adjustment
- R510**
AM carrier
adjustment

TRANSMITTER ADJUSTMENTS—continued

ADJUSTMENT	ADJUSTMENT CONDITION	MEASUREMENT		VALUE	ADJUSTMENT POINT	
		UNIT	LOCATION		UNIT	ADJUST
RESIDUAL AM	1 <ul style="list-style-type: none"> • Display frequency: 29.60000 MHz • Mode : FM • Filter : 15 kHz • [RF POWER] : Max. CW • [MIC GAIN] : Max. CW and CCW • [MONI] : OFF • Connect CP503 on the MAIN unit to GND. • Connect an audio generator to [MIC] connector and set as: <ul style="list-style-type: none"> Frequency : 1 kHz Level : 10 mVrms • Transmitting 	Rear panel	Connect an RF power meter to [ANT1] connector.	Minimum power difference with minimum MIC GAIN and maximum MIC GAIN.	RF	L713, L712, L711
FM DEVIATION	1 <ul style="list-style-type: none"> • Displayed freq. : 29.60000 MHz • Mode : FM • Filter : 15 kHz • [RF POWER] : Max. CW • [MIC GAIN] : Center • Connect an audio generator to [MIC] connector and set as: <ul style="list-style-type: none"> Frequency : 1 kHz Level : 10 mVrms • Transmitting 	Rear panel	Connect an FM deviation meter to [ANT1] connector through an attenuator.	±4.5 kHz	DSP	R2227
AM MODULATION	1 <ul style="list-style-type: none"> • Display frequency: 14.10000 MHz • Mode : AM • [MIC GAIN] : Center • [RF POWER] : Max. CCW • Connect an audio generator to [MIC] connector and set as: <ul style="list-style-type: none"> Frequency : 1 kHz Level : 10 mVrms • Transmitting 	Rear panel	Connect a modulation analyzer to [ANT1] connector through an attenuator.	90%	DSP	R2229

4-5 TUNER ADJUSTMENT

ADJUSTMENT	ADJUSTMENT CONDITION	MEASUREMENT		VALUE	ADJUSTMENT POINT	
		UNIT	LOCATION		UNIT	ADJUST
SWR DETECTOR	1 <ul style="list-style-type: none"> • Display frequency: 29.70000 MHz • Mode : FM • [RF POWER] : Max. CW • [TUNER] : Through • Connect J12 on the CTRL unit to GND. • Connect a 50 Ω terminator to [ANT1] connector. • Transmitting 	CTRL	Connect a digital multimeter or oscilloscope to J14.	Minimum voltage	CTRL	C3
	2 <ul style="list-style-type: none"> • Terminate [REMOTE] jack with a 3.5(d) mm mini-plug. 			<ul style="list-style-type: none"> • While pushing [SSB] and [CW], turn power ON. • Verify the display shows "SETUP START". 		
	3			<ul style="list-style-type: none"> • Push [F-5 (TUNER)]. • Verify the display shows "TUNER CAL". 		
	4			<ul style="list-style-type: none"> • Push [F-5 (START)]. • Verify the display shows "END". 		
	After adjustment, disconnect J12 on the CTRL board from GND.					

• RF unit

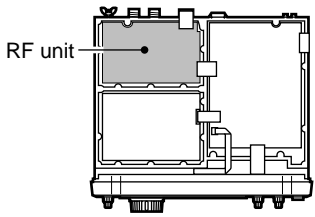

Bottom view of the transceiver

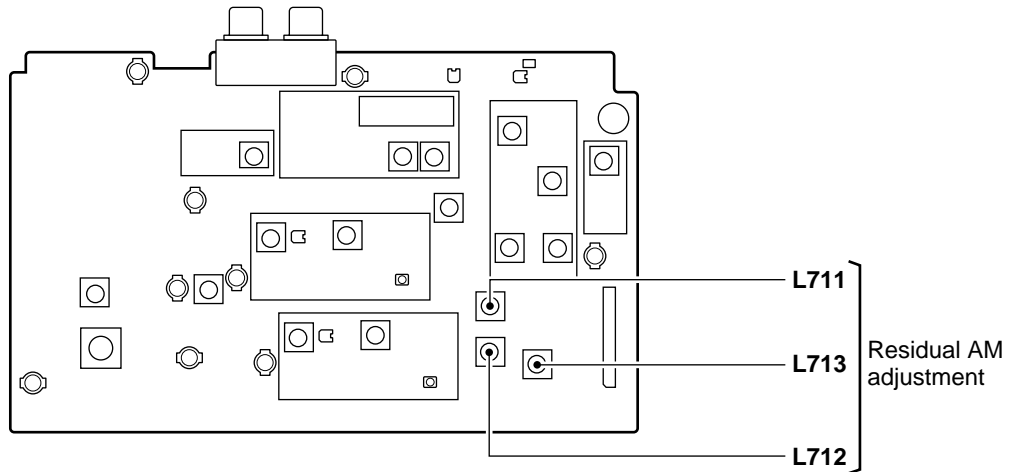

• MAIN unit and DSP board

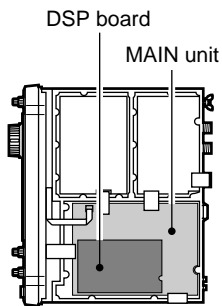

Bottom view of the transceiver

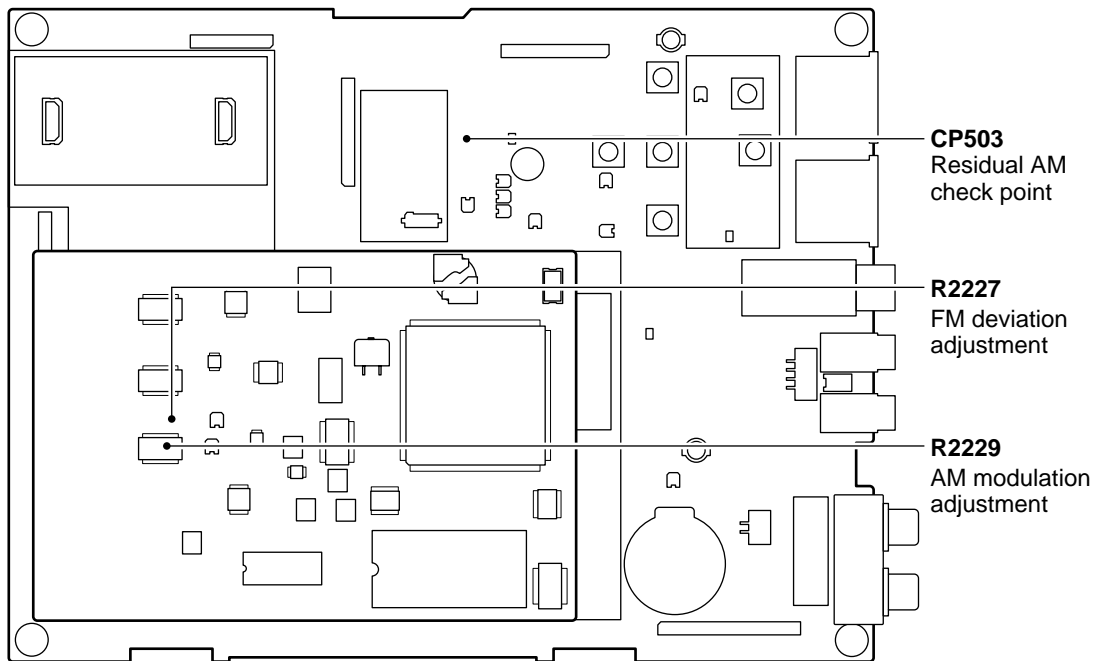

• CTRL unit

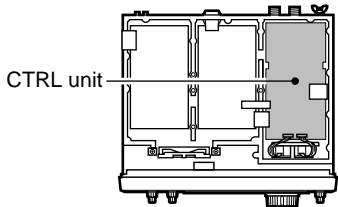

Top view of the transceiver

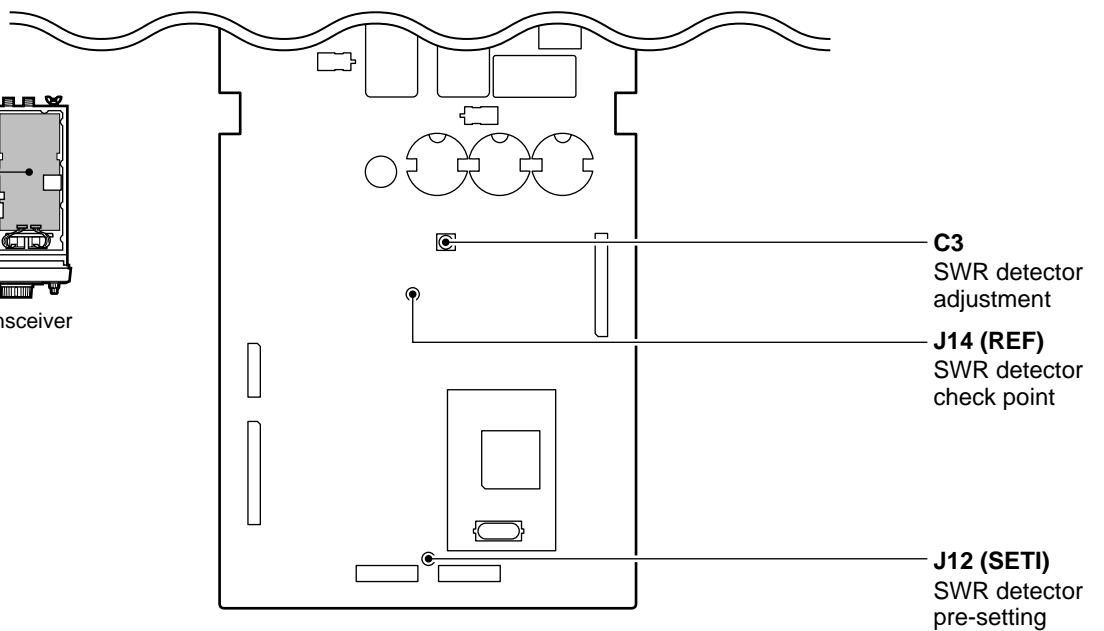

SECTION 5 PARTS LIST

[FRONT UNIT]

REF NO.	ORDER NO.	DESCRIPTION	
DS1	5080000450	LAMP	SLU2LC1EX5B-TH
ME1	5510000480	METER	ME-40 (KL-293S-10)
W1	8900009230	CABLE	OPC-908
W2	8900009660	CABLE	OPC-964
W3	8900009230	CABLE	OPC-908
W4	8900009240	CABLE	OPC-909
W5	8900009240	CABLE	OPC-909
W6	8900009260	CABLE	OPC-911
W7	8900009260	CABLE	OPC-911
W8	8900009400	CABLE	OPC-926
EP1	6910011090	SENSOR UNIT	RMS20-250-201-P
EP2	6450001230	E.OTHER	HLJ0999-01-480
EP3	6450001230	E.OTHER	HLJ0999-01-480
EP4	6910012500	UNIT BOARD	TFD50W40-A

[DISPLAY BOARD]

REF NO.	ORDER NO.	DESCRIPTION	
IC101	1130002660	S.IC	μPD4030BG-T1
IC102	1130008650	S.IC	MC14071BF-EL
IC401	1140003670	S.IC	HD6473834H (Z-TAT)
IC411	1130009640	S.IC	BU4051BCFV-E2
IC431	1130009490	S.IC	TC74HC4050AF (EL)
IC490	1130009110	S.IC	S-80942ANMP-DD6-T2
IC492	1130003760	S.IC	TC4S81F (TE85R)
IC501	1180001920	S.IC	TA79L08F (TE12L)
IC511	1110003780	S.IC	NJM2902V-TE1
IC542	1120002740	S.IC	TK16105MTL
IC821	1110002350	S.IC	BA6161F
IC841	1110004200	S.IC	NJM2360M-TE3
IC861	1180001070	S.IC	TA7805F (TE16L)
IC881	1180001920	S.IC	TA79L08F (TE12L)
IC1401	1120002580	S.IC	M52338FP
IC1521	1110003750	S.IC	M5218AFP 600C
Q321	1590002310	S.TRANSISTOR	DTC114EE TL
Q511	1590002310	S.TRANSISTOR	DTC114EE TL
Q512	1520000460	S.TRANSISTOR	2SB1132 T100 R
Q513	1590002310	S.TRANSISTOR	DTC114EE TL
Q514	1520000460	S.TRANSISTOR	2SB1132 T100 R
Q515	1590002310	S.TRANSISTOR	DTC114EE TL
Q622	1590002310	S.TRANSISTOR	DTC114EE TL
Q623	1590002310	S.TRANSISTOR	DTC114EE TL
Q624	1590002310	S.TRANSISTOR	DTC114EE TL
Q625	1590002310	S.TRANSISTOR	DTC114EE TL
Q701	1590002310	S.TRANSISTOR	DTC114EE TL
Q801	1530002060	S.TRANSISTOR	2SC4081 T107 R
Q802	1520000650	S.TRANSISTOR	2SB1201-S-TL
Q803	1530003300	S.TRANSISTOR	2SC3647S-TD
Q804	1530003300	S.TRANSISTOR	2SC3647S-TD
Q805	1590002310	S.TRANSISTOR	DTC114EE TL
Q821	1530002060	S.TRANSISTOR	2SC4081 T107 R
Q841	1520000580	S.TRANSISTOR	2SB1124S-TD
Q901	1590002310	S.TRANSISTOR	DTC114EE TL
Q902	1590002310	S.TRANSISTOR	DTC114EE TL
Q903	1590002310	S.TRANSISTOR	DTC114EE TL
Q904	1530002060	S.TRANSISTOR	2SC4081 T107 R
Q905	1520000650	S.TRANSISTOR	2SB1201-S-TL
Q1201	1510000510	S.TRANSISTOR	2SA1576A T106R
Q1211	1510000510	S.TRANSISTOR	2SA1576A T106R
Q1221	1510000510	S.TRANSISTOR	2SA1576A T106R
Q1301	1530002060	S.TRANSISTOR	2SC4081 T107 R
Q1551	1530002060	S.TRANSISTOR	2SC4081 T107 R
Q1552	1510000510	S.TRANSISTOR	2SA1576A T106R

[DISPLAY BOARD]

REF NO.	ORDER NO.	DESCRIPTION	
Q1553	1510000510	S.TRANSISTOR	2SA1576A T106R
Q1554	1530002060	S.TRANSISTOR	2SC4081 T107 R
D421	1750000520	S.DIODE	DAN222TL
D422	1750000520	S.DIODE	DAN222TL
D423	1750000520	S.DIODE	DAN222TL
D424	1750000520	S.DIODE	DAN222TL
D425	1750000520	S.DIODE	DAN222TL
D431	1750000520	S.DIODE	DAN222TL
D432	1750000520	S.DIODE	DAN222TL
D501	1750000190	S.DIODE	1SS322 (TE85R)
D509	1750000190	S.DIODE	1SS322 (TE85R)
D511	1730002260	S.ZENER	MA8030-H (TX)
D512	1730000410	S.ZENER	RD5.1M-T2B2
D531	1730002260	S.ZENER	MA8030-H (TX)
D701	1750000520	S.DIODE	DAN222TL
D801	1730002260	S.ZENER	MA8030-H (TX)
D821	1750000190	S.DIODE	1SS322 (TE85R)
D822	1730001050	S.ZENER	RD20M-T2B1
D841	1750000560	S.DIODE	RB050L-40 TE-25
D901	1730000410	S.ZENER	RD5.1M-T2B2
D1201	1730002260	S.ZENER	MA8030-H (TX)
D1211	1730002260	S.ZENER	MA8030-H (TX)
D1221	1730002260	S.ZENER	MA8030-H (TX)
X401	6050009870	S.XTAL	CR-567 (9.8304 MHz)
L321	6200003950	S.COIL	HF50ACC 322513-T
L322	6200003950	S.COIL	HF50ACC 322513-T
L323	6200003950	S.COIL	HF50ACC 322513-T
L401	6200003950	S.COIL	HF50ACC 322513-T
L801	6180000990	COIL	LAL 04NA 101K
L802	6190001190	S.COIL	D10F-A814AY-101K=P3
L803	6190001180	S.COIL	BLC13H-D818HN-1107
L821	6200003950	S.COIL	HF50ACC 322513-T
L822	6200009190	S.COIL	NLFC565050T-472K
L823	6200003520	S.COIL	ELJFB 102K-F
L841	6190001190	S.COIL	D10F-A814AY-101K=P3
L842	6180003250	S.COIL	SLF12565T-680M2R0
L843	6190001190	S.COIL	D10F-A814AY-101K=P3
R101	7030003320	S.RESISTOR	ERJ3GEYJ 101 V (100 Ω)
R102	7030003580	S.RESISTOR	ERJ3GEYJ 153 V (15 kΩ)
R103	7030003580	S.RESISTOR	ERJ3GEYJ 153 V (15 kΩ)
R104	7030003640	S.RESISTOR	ERJ3GEYJ 473 V (47 kΩ)
R105	7030003320	S.RESISTOR	ERJ3GEYJ 101 V (100 Ω)
R106	7030003720	S.RESISTOR	ERJ3GEYJ 224 V (220 kΩ)
R107	7030003720	S.RESISTOR	ERJ3GEYJ 224 V (220 kΩ)
R121	7030003680	S.RESISTOR	ERJ3GEYJ 104 V (100 kΩ)
R122	7030003720	S.RESISTOR	ERJ3GEYJ 224 V (220 kΩ)
R123	7030003680	S.RESISTOR	ERJ3GEYJ 104 V (100 kΩ)
R124	7030003800	S.RESISTOR	ERJ3GEYJ 105 V (1 MΩ)
R125	7030003680	S.RESISTOR	ERJ3GEYJ 104 V (100 kΩ)
R126	7030003720	S.RESISTOR	ERJ3GEYJ 224 V (220 kΩ)
R127	7030003680	S.RESISTOR	ERJ3GEYJ 104 V (100 kΩ)
R128	7030003800	S.RESISTOR	ERJ3GEYJ 105 V (1 MΩ)
R201	7030003440	S.RESISTOR	ERJ3GEYJ 102 V (1 kΩ)
R202	7030003440	S.RESISTOR	ERJ3GEYJ 102 V (1 kΩ)
R203	7030003440	S.RESISTOR	ERJ3GEYJ 102 V (1 kΩ)
R204	7030003440	S.RESISTOR	ERJ3GEYJ 102 V (1 kΩ)
R205	7030003440	S.RESISTOR	ERJ3GEYJ 102 V (1 kΩ)
R206	7030003440	S.RESISTOR	ERJ3GEYJ 102 V (1 kΩ)
R207	7030003440	S.RESISTOR	ERJ3GEYJ 102 V (1 kΩ)
R208	7030003440	S.RESISTOR	ERJ3GEYJ 102 V (1 kΩ)
R209	7030003440	S.RESISTOR	ERJ3GEYJ 102 V (1 kΩ)
R210	7030003440	S.RESISTOR	ERJ3GEYJ 102 V (1 kΩ)
R211	7030003440	S.RESISTOR	ERJ3GEYJ 102 V (1 kΩ)
R212	7030003640	S.RESISTOR	ERJ3GEYJ 473 V (47 kΩ)
R213	7030003640	S.RESISTOR	ERJ3GEYJ 473 V (47 kΩ)
R214	7030003640	S.RESISTOR	ERJ3GEYJ 473 V (47 kΩ)
R215	7030003640	S.RESISTOR	ERJ3GEYJ 473 V (47 kΩ)
R221	7030003440	S.RESISTOR	ERJ3GEYJ 102 V (1 kΩ)

S.=Surface mount

[DISPLAY BOARD]

REF NO.	ORDER NO.	DESCRIPTION	
R222	7030003440	S.RESISTOR	ERJ3GEYJ 102 V (1 kΩ)
R223	7030003440	S.RESISTOR	ERJ3GEYJ 102 V (1 kΩ)
R224	7030003440	S.RESISTOR	ERJ3GEYJ 102 V (1 kΩ)
R225	7030003440	S.RESISTOR	ERJ3GEYJ 102 V (1 kΩ)
R226	7030003440	S.RESISTOR	ERJ3GEYJ 102 V (1 kΩ)
R227	7030003440	S.RESISTOR	ERJ3GEYJ 102 V (1 kΩ)
R228	7030003440	S.RESISTOR	ERJ3GEYJ 102 V (1 kΩ)
R229	7030003440	S.RESISTOR	ERJ3GEYJ 102 V (1 kΩ)
R230	7030003440	S.RESISTOR	ERJ3GEYJ 102 V (1 kΩ)
R231	7030003440	S.RESISTOR	ERJ3GEYJ 102 V (1 kΩ)
R232	7030003440	S.RESISTOR	ERJ3GEYJ 102 V (1 kΩ)
R233	7030003440	S.RESISTOR	ERJ3GEYJ 102 V (1 kΩ)
R234	7030003440	S.RESISTOR	ERJ3GEYJ 102 V (1 kΩ)
R235	7030003440	S.RESISTOR	ERJ3GEYJ 102 V (1 kΩ)
R241	7030003440	S.RESISTOR	ERJ3GEYJ 102 V (1 kΩ)
R242	7030003440	S.RESISTOR	ERJ3GEYJ 102 V (1 kΩ)
R243	7030003440	S.RESISTOR	ERJ3GEYJ 102 V (1 kΩ)
R244	7030003440	S.RESISTOR	ERJ3GEYJ 102 V (1 kΩ)
R245	7030003440	S.RESISTOR	ERJ3GEYJ 102 V (1 kΩ)
R246	7030003440	S.RESISTOR	ERJ3GEYJ 102 V (1 kΩ)
R247	7030003440	S.RESISTOR	ERJ3GEYJ 102 V (1 kΩ)
R248	7030003440	S.RESISTOR	ERJ3GEYJ 102 V (1 kΩ)
R249	7030003440	S.RESISTOR	ERJ3GEYJ 102 V (1 kΩ)
R250	7030003440	S.RESISTOR	ERJ3GEYJ 102 V (1 kΩ)
R251	7030003440	S.RESISTOR	ERJ3GEYJ 102 V (1 kΩ)
R252	7030003440	S.RESISTOR	ERJ3GEYJ 102 V (1 kΩ)
R253	7030003440	S.RESISTOR	ERJ3GEYJ 102 V (1 kΩ)
R254	7030003440	S.RESISTOR	ERJ3GEYJ 102 V (1 kΩ)
R255	7030003440	S.RESISTOR	ERJ3GEYJ 102 V (1 kΩ)
R256	7030003440	S.RESISTOR	ERJ3GEYJ 102 V (1 kΩ)
R301	7030003440	S.RESISTOR	ERJ3GEYJ 102 V (1 kΩ)
R312	7030003440	S.RESISTOR	ERJ3GEYJ 102 V (1 kΩ)
R313	7030003440	S.RESISTOR	ERJ3GEYJ 102 V (1 kΩ)
R315	7030003280	S.RESISTOR	ERJ3GEYJ 470 V (47 Ω)
R316	7030003280	S.RESISTOR	ERJ3GEYJ 470 V (47 Ω)
R317	7030003280	S.RESISTOR	ERJ3GEYJ 470 V (47 Ω)
R318	7030003440	S.RESISTOR	ERJ3GEYJ 102 V (1 kΩ)
R319	7030003440	S.RESISTOR	ERJ3GEYJ 102 V (1 kΩ)
R321	7030003560	S.RESISTOR	ERJ3GEYJ 103 V (10 kΩ)
R401	7030003800	S.RESISTOR	ERJ3GEYJ 105 V (1 MΩ)
R402	7030003440	S.RESISTOR	ERJ3GEYJ 102 V (1 kΩ)
R403	7030003680	S.RESISTOR	ERJ3GEYJ 104 V (100 kΩ)
R404	7030003640	S.RESISTOR	ERJ3GEYJ 473 V (47 kΩ)
R405	7030003640	S.RESISTOR	ERJ3GEYJ 473 V (47 kΩ)
R406	7030003640	S.RESISTOR	ERJ3GEYJ 473 V (47 kΩ)
R407	7030003640	S.RESISTOR	ERJ3GEYJ 473 V (47 kΩ)
R408	7030003640	S.RESISTOR	ERJ3GEYJ 473 V (47 kΩ)
R409	7030003640	S.RESISTOR	ERJ3GEYJ 473 V (47 kΩ)
R410	7030003640	S.RESISTOR	ERJ3GEYJ 473 V (47 kΩ)
R411	7030003640	S.RESISTOR	ERJ3GEYJ 473 V (47 kΩ)
R412	7030003640	S.RESISTOR	ERJ3GEYJ 473 V (47 kΩ)
R413	7030003640	S.RESISTOR	ERJ3GEYJ 473 V (47 kΩ)
R414	7030003640	S.RESISTOR	ERJ3GEYJ 473 V (47 kΩ)
R415	7030003640	S.RESISTOR	ERJ3GEYJ 473 V (47 kΩ)
R416	7030003640	S.RESISTOR	ERJ3GEYJ 473 V (47 kΩ)
R421	7030003440	S.RESISTOR	ERJ3GEYJ 102 V (1 kΩ)
R424	7030003440	S.RESISTOR	ERJ3GEYJ 102 V (1 kΩ)
R431	7030003480	S.RESISTOR	ERJ3GEYJ 222 V (2.2 kΩ)
R432	7030003640	S.RESISTOR	ERJ3GEYJ 473 V (47 kΩ)
R441	7030003560	S.RESISTOR	ERJ3GEYJ 103 V (10 kΩ)
R442	7030003640	S.RESISTOR	ERJ3GEYJ 473 V (47 kΩ)
R443	7030003640	S.RESISTOR	ERJ3GEYJ 473 V (47 kΩ)
R444	7030003560	S.RESISTOR	ERJ3GEYJ 103 V (10 kΩ)
R445	7030003560	S.RESISTOR	ERJ3GEYJ 103 V (10 kΩ)
R446	7030003560	S.RESISTOR	ERJ3GEYJ 103 V (10 kΩ)
R447	7030003320	S.RESISTOR	ERJ3GEYJ 101 V (100 Ω)
R490	7030003630	S.RESISTOR	ERJ3GEYJ 393 V (39 kΩ)
R491	7030003640	S.RESISTOR	ERJ3GEYJ 473 V (47 kΩ)
R492	7030003560	S.RESISTOR	ERJ3GEYJ 103 V (10 kΩ)
R493	7030003440	S.RESISTOR	ERJ3GEYJ 102 V (1 kΩ)
R494	7030003680	S.RESISTOR	ERJ3GEYJ 104 V (100 kΩ)
R501	7030003440	S.RESISTOR	ERJ3GEYJ 102 V (1 kΩ)
R502	7030003580	S.RESISTOR	ERJ3GEYJ 153 V (15 kΩ)
R503	7030003440	S.RESISTOR	ERJ3GEYJ 102 V (1 kΩ)
R511	7030003560	S.RESISTOR	ERJ3GEYJ 103 V (10 kΩ)
R512	7030003480	S.RESISTOR	ERJ3GEYJ 222 V (2.2 kΩ)
R513	7030003450	S.RESISTOR	ERJ3GEYJ 122 V (1.2 kΩ)
R514	7030003430	S.RESISTOR	ERJ3GEYJ 821 V (820 Ω)
R515	7030003560	S.RESISTOR	ERJ3GEYJ 103 V (10 kΩ)
R518	7030003720	S.RESISTOR	ERJ3GEYJ 224 V (220 kΩ)
R519	7030003720	S.RESISTOR	ERJ3GEYJ 224 V (220 kΩ)
R520	7030003720	S.RESISTOR	ERJ3GEYJ 224 V (220 kΩ)

[DISPLAY BOARD]

REF NO.	ORDER NO.	DESCRIPTION	
R521	7030003470	S.RESISTOR	ERJ3GEYJ 182 V (1.8 kΩ)
R531	7030003470	S.RESISTOR	ERJ3GEYJ 182 V (1.8 kΩ)
R532	7030003630	S.RESISTOR	ERJ3GEYJ 393 V (39 kΩ)
R533	7030003560	S.RESISTOR	ERJ3GEYJ 103 V (10 kΩ)
R541	7030003560	S.RESISTOR	ERJ3GEYJ 103 V (10 kΩ)
R544	7030003200	S.RESISTOR	ERJ3GEYJ 100 V (10 Ω)
R601	7030003640	S.RESISTOR	ERJ3GEYJ 473 V (47 kΩ)
R602	7030003640	S.RESISTOR	ERJ3GEYJ 473 V (47 kΩ)
R621	7030003480	S.RESISTOR	ERJ3GEYJ 222 V (2.2 kΩ)
R622	7030003540	S.RESISTOR	ERJ3GEYJ 682 V (6.8 kΩ)
R623	7030003480	S.RESISTOR	ERJ3GEYJ 222 V (2.2 kΩ)
R624	7030003520	S.RESISTOR	ERJ3GEYJ 472 V (4.7 kΩ)
R625	7030003580	S.RESISTOR	ERJ3GEYJ 153 V (15 kΩ)
R626	7030009950	S.RESISTOR	ERJ8GEYJ 681V (680 Ω)
R627	7030009950	S.RESISTOR	ERJ8GEYJ 681V (680 Ω)
R628	7030009950	S.RESISTOR	ERJ8GEYJ 681V (680 Ω)
R629	7030009950	S.RESISTOR	ERJ8GEYJ 681V (680 Ω)
R701	7210002890	VARIABLE	RV-308
R702	7210002890	VARIABLE	RV-308
R703	7030003640	S.RESISTOR	ERJ3GEYJ 473 V (47 kΩ)
R704	7030003640	S.RESISTOR	ERJ3GEYJ 473 V (47 kΩ)
R705	7030003640	S.RESISTOR	ERJ3GEYJ 473 V (47 kΩ)
R706	7030003640	S.RESISTOR	ERJ3GEYJ 473 V (47 kΩ)
R707	7030003510	S.RESISTOR	ERJ3GEYJ 392 V (3.9 kΩ)
R708	7030003480	S.RESISTOR	ERJ3GEYJ 222 V (2.2 kΩ)
R709	7030003560	S.RESISTOR	ERJ3GEYJ 103 V (10 kΩ)
R711	7030003640	S.RESISTOR	ERJ3GEYJ 473 V (47 kΩ)
R712	7210002630	VARIABLE	EVU-FLAE02 B14 (10KB)
R713	7030003640	S.RESISTOR	ERJ3GEYJ 473 V (47 kΩ)
R714	7210002630	VARIABLE	EVU-FLAE02 B14 (10KB)
R715	7030003640	S.RESISTOR	ERJ3GEYJ 473 V (47 kΩ)
R716	7210002630	VARIABLE	EVU-FLAE02 B14 (10KB)
R717	7030003640	S.RESISTOR	ERJ3GEYJ 473 V (47 kΩ)
R718	7210002630	VARIABLE	EVU-FLAE02 B14 (10KB)
R719	7030003640	S.RESISTOR	ERJ3GEYJ 473 V (47 kΩ)
R720	7210002630	VARIABLE	EVU-FLAE02 B14 (10KB)
R801	7030003620	S.RESISTOR	ERJ3GEYJ 333 V (33 kΩ)
R802	7030003620	S.RESISTOR	ERJ3GEYJ 333 V (33 kΩ)
R803	7030000300	S.RESISTOR	MCR10EZHZ 220 Ω (221)
R804	7030003500	S.RESISTOR	ERJ3GEYJ 332 V (3.3 kΩ)
R805	7030003500	S.RESISTOR	ERJ3GEYJ 332 V (3.3 kΩ)
R806	7030003640	S.RESISTOR	ERJ3GEYJ 473 V (47 kΩ)
R807	7030008380	S.RESISTOR	ERJ1WYJ270H (27 Ω)
R808	7030008380	S.RESISTOR	ERJ1WYJ270H (27 Ω)
R821	7030003450	S.RESISTOR	ERJ3GEYJ 122 V (1.2 kΩ)
R824	7030003560	S.RESISTOR	ERJ3GEYJ 103 V (10 kΩ)
R841	7030009740	S.RESISTOR	ERJ12RQJ0R33U (0.33 Ω)
R842	7030009740	S.RESISTOR	ERJ12RQJ0R33U (0.33 Ω)
R845	7030006580	S.RESISTOR	RR0816P-122-D (1.2 kΩ)
R846	7030008070	S.RESISTOR	RR0816P-273-D (27 kΩ)
R847	7030008070	S.RESISTOR	RR0816P-273-D (27 kΩ)
R848	7030006260	S.RESISTOR	ERJ12YJ471H (470 Ω)
R849	7030006260	S.RESISTOR	ERJ12YJ471H (470 Ω)
R850	7030003380	S.RESISTOR	ERJ3GEYJ 331 V (330 Ω)
R861	7030007120	S.RESISTOR	ERJ1WYJ120H (12 Ω)
R862	7030007120	S.RESISTOR	ERJ1WYJ120H (12 Ω)
R863	7030007120	S.RESISTOR	ERJ1WYJ120H (12 Ω)
R881	7030006140	S.RESISTOR	ERJ1WYJ560H (56 Ω)
R882	7030006140	S.RESISTOR	ERJ1WYJ560H (56 Ω)
R904	7030003520	S.RESISTOR	ERJ3GEYJ 472 V (4.7 kΩ)
R905	7030003540	S.RESISTOR	ERJ3GEYJ 682 V (6.8 kΩ)
R906	7030003580	S.RESISTOR	ERJ3GEYJ 153 V (15 kΩ)
R907	7030003580	S.RESISTOR	ERJ3GEYJ 153 V (15 kΩ)
R908	7030003520	S.RESISTOR	ERJ3GEYJ 472 V (4.7 kΩ)
R909	7030003400	S.RESISTOR	ERJ3GEYJ 471 V (470 Ω)
R910	7030000350	S.RESISTOR	MCR10EZHZ 560 Ω (561)
R912	7030009940	S.RESISTOR	ERJ8GEYJ 331V (330 Ω)
R914	7030009940	S.RESISTOR	ERJ8GEYJ 331V (330 Ω)
R915	7030003560	S.RESISTOR	ERJ3GEYJ 103 V (10 kΩ)
R916	7030003480	S.RESISTOR	ERJ3GEYJ 222 V (2.2 kΩ)
R917	7030003520	S.RESISTOR	ERJ3GEYJ 472 V (4.7 kΩ)
R1101	7030003640	S.RESISTOR	ERJ3GEYJ 473 V (47 kΩ)
R1103	7030003560	S.RESISTOR	ERJ3GEYJ 103 V (10 kΩ)
R1104	7030003600	S.RESISTOR	ERJ3GEYJ 223 V (22 kΩ)
R1106	7030003590	S.RESISTOR	ERJ3GEYJ 183 V (18 kΩ)
R1107	7030003570	S.RESISTOR	ERJ3GEYJ 123 V (12 kΩ)
R1109	7030003620	S.RESISTOR	ERJ3GEYJ 333 V (33 kΩ)
R1110	7030003660	S.RESISTOR	ERJ3GEYJ 683 V (68 kΩ)
R1112	7030003620	S.RESISTOR	ERJ3GEYJ 333 V (33 kΩ)
R1113	7030003610	S.RESISTOR	ERJ3GEYJ 273 V (27 kΩ)
R1121	7030003610	S.RESISTOR	ERJ3GEYJ 273 V (27 kΩ)
R1122	7030003520	S.RESISTOR	ERJ3GEYJ 472 V (4.7 kΩ)

S.=Surface mount

[DISPLAY BOARD]

REF NO.	ORDER NO.	DESCRIPTION	
R1127	7030003490	S.RESISTOR	ERJ3GEYJ 272 V (2.7 kΩ)
R1128	7030003670	S.RESISTOR	ERJ3GEYJ 823 V (82 kΩ)
R1201	7030003340	S.RESISTOR	ERJ3GEYJ 151 V (150 Ω)
R1202	7030003450	S.RESISTOR	ERJ3GEYJ 122 V (1.2 kΩ)
R1203	7030003490	S.RESISTOR	ERJ3GEYJ 272 V (2.7 kΩ)
R1211	7030003340	S.RESISTOR	ERJ3GEYJ 151 V (150 Ω)
R1212	7030003450	S.RESISTOR	ERJ3GEYJ 122 V (1.2 kΩ)
R1213	7030003490	S.RESISTOR	ERJ3GEYJ 272 V (2.7 kΩ)
R1221	7030003340	S.RESISTOR	ERJ3GEYJ 151 V (150 Ω)
R1222	7030003450	S.RESISTOR	ERJ3GEYJ 122 V (1.2 kΩ)
R1223	7030003490	S.RESISTOR	ERJ3GEYJ 272 V (2.7 kΩ)
R1526	7030003320	S.RESISTOR	ERJ3GEYJ 101 V (100 Ω)
R1527	7030003320	S.RESISTOR	ERJ3GEYJ 101 V (100 Ω)
R1541	7030003560	S.RESISTOR	ERJ3GEYJ 103 V (10 kΩ)
R1542	7030003600	S.RESISTOR	ERJ3GEYJ 223 V (22 kΩ)
R1543	7030003600	S.RESISTOR	ERJ3GEYJ 223 V (22 kΩ)
R1544	7030003480	S.RESISTOR	ERJ3GEYJ 222 V (2.2 kΩ)
R1545	7030003480	S.RESISTOR	ERJ3GEYJ 222 V (2.2 kΩ)
R1551	7030003320	S.RESISTOR	ERJ3GEYJ 101 V (100 Ω)
R1552	7030003320	S.RESISTOR	ERJ3GEYJ 101 V (100 Ω)
R1553	7030003720	S.RESISTOR	ERJ3GEYJ 224 V (220 kΩ)
R1554	7030003720	S.RESISTOR	ERJ3GEYJ 224 V (220 kΩ)
R1555	7030003600	S.RESISTOR	ERJ3GEYJ 223 V (22 kΩ)
R1556	7030003600	S.RESISTOR	ERJ3GEYJ 223 V (22 kΩ)
R1560	7030003530	S.RESISTOR	ERJ3GEYJ 562 V (5.6 kΩ)
R1561	7030003610	S.RESISTOR	ERJ3GEYJ 273 V (27 kΩ)
C101	4030011600	S.CERAMIC	C1608 JB 1C 104KT-N
C102	4030006860	S.CERAMIC	C1608 JB 1H 102K-T-A
C103	4030006860	S.CERAMIC	C1608 JB 1H 102K-T-A
C104	4030006860	S.CERAMIC	C1608 JB 1H 102K-T-A
C105	4030011600	S.CERAMIC	C1608 JB 1C 104KT-N
C121	4030006860	S.CERAMIC	C1608 JB 1H 102K-T-A
C122	4030006860	S.CERAMIC	C1608 JB 1H 102K-T-A
C241	4030011600	S.CERAMIC	C1608 JB 1C 104KT-N
C242	4030011600	S.CERAMIC	C1608 JB 1C 104KT-N
C331	4030006850	S.CERAMIC	C1608 JB 1H 471K-T-A
C332	4030006880	S.CERAMIC	C1608 JB 1H 472K-T-A
C401	4030007020	S.CERAMIC	C1608 CH 1H 120J-T-A
C402	4030007020	S.CERAMIC	C1608 CH 1H 120J-T-A
C403	4030011600	S.CERAMIC	C1608 JB 1C 104KT-N
C404	4030011600	S.CERAMIC	C1608 JB 1C 104KT-N
C405	4030011600	S.CERAMIC	C1608 JB 1C 104KT-N
C406	4510006650	S.ELECTROLYTIC	ECEV1EA100SR
C411	4030011600	S.CERAMIC	C1608 JB 1C 104KT-N
C431	4030011600	S.CERAMIC	C1608 JB 1C 104KT-N
C490	4030011600	S.CERAMIC	C1608 JB 1C 104KT-N
C491	4030007020	S.CERAMIC	C1608 CH 1H 120J-T-A
C492	4030006880	S.CERAMIC	C1608 JB 1H 472K-T-A
C501	4510006650	S.ELECTROLYTIC	ECEV1EA100SR
C502	4030011600	S.CERAMIC	C1608 JB 1C 104KT-N
C503	4030011600	S.CERAMIC	C1608 JB 1C 104KT-N
C504	4510005310	S.ELECTROLYTIC	ECEV1CA220SR
C513	4030011600	S.CERAMIC	C1608 JB 1C 104KT-N
C531	4030006880	S.CERAMIC	C1608 JB 1H 472K-T-A
C542	4030011600	S.CERAMIC	C1608 JB 1C 104KT-N
C545	4510006650	S.ELECTROLYTIC	ECEV1EA100SR
C601	4030006880	S.CERAMIC	C1608 JB 1H 472K-T-A
C602	4030006880	S.CERAMIC	C1608 JB 1H 472K-T-A
C603	4030006860	S.CERAMIC	C1608 JB 1H 102K-T-A
C604	4030006860	S.CERAMIC	C1608 JB 1H 102K-T-A
C605	4030006860	S.CERAMIC	C1608 JB 1H 102K-T-A
C606	4030006860	S.CERAMIC	C1608 JB 1H 102K-T-A
C621	4030011600	S.CERAMIC	C1608 JB 1C 104KT-N
C701	4030011600	S.CERAMIC	C1608 JB 1C 104KT-N
C702	4030011600	S.CERAMIC	C1608 JB 1C 104KT-N
C703	4030006880	S.CERAMIC	C1608 JB 1H 472K-T-A
C704	4030006880	S.CERAMIC	C1608 JB 1H 472K-T-A
C711	4030006880	S.CERAMIC	C1608 JB 1H 472K-T-A
C712	4030006880	S.CERAMIC	C1608 JB 1H 472K-T-A
C713	4030006880	S.CERAMIC	C1608 JB 1H 472K-T-A
C714	4030006880	S.CERAMIC	C1608 JB 1H 472K-T-A
C715	4030006880	S.CERAMIC	C1608 JB 1H 472K-T-A
C801	4510006650	S.ELECTROLYTIC	ECEV1EA100SR
C802	4510006650	S.ELECTROLYTIC	ECEV1EA100SR
C803	4510006230	S.ELECTROLYTIC	ECEV1EA470UP
C804	4340000170	S.MYLAR	MMX-E 2A 473J
C805	4030016880	S.CERAMIC	C4520 CH 3F 150KT-A
C821	4030011600	S.CERAMIC	C1608 JB 1C 104KT-N
C822	4510006230	S.ELECTROLYTIC	ECEV1EA470UP
C823	4030006880	S.CERAMIC	C1608 JB 1H 472K-T-A

[DISPLAY BOARD]

REF NO.	ORDER NO.	DESCRIPTION	
C824	4030006880	S.CERAMIC	C1608 JB 1H 472K-T-A
C825	4030006880	S.CERAMIC	C1608 JB 1H 472K-T-A
C826	4510005360	S.ELECTROLYTIC	ECEV1HA4R7SR
C827	4510005360	S.ELECTROLYTIC	ECEV1HA4R7SR
C828	4510006650	S.ELECTROLYTIC	ECEV1EA100SR
C829	4510005360	S.ELECTROLYTIC	ECEV1HA4R7SR
C830	4510006650	S.ELECTROLYTIC	ECEV1EA100SR
C841	4510006240	S.ELECTROLYTIC	ECEV1CA221P
C842	4030011600	S.CERAMIC	C1608 JB 1C 104KT-N
C843	4030010760	S.CERAMIC	C1608 CH 1H 331J-T-A
C844	4510006240	S.ELECTROLYTIC	ECEV1CA221P
C845	4030011600	S.CERAMIC	C1608 JB 1C 104KT-N
C846	4510006240	S.ELECTROLYTIC	ECEV1CA221P
C847	4510006240	S.ELECTROLYTIC	ECEV1CA221P
C848	4030011600	S.CERAMIC	C1608 JB 1C 104KT-N
C849	4510006240	S.ELECTROLYTIC	ECEV1CA221P
C850	4510006240	S.ELECTROLYTIC	ECEV1CA221P
C861	4510006650	S.ELECTROLYTIC	ECEV1EA100SR
C862	4030011600	S.CERAMIC	C1608 JB 1C 104KT-N
C863	4030011600	S.CERAMIC	C1608 JB 1C 104KT-N
C864	4510005310	S.ELECTROLYTIC	ECEV1CA220SR
C881	4510006650	S.ELECTROLYTIC	ECEV1EA100SR
C882	4030011600	S.CERAMIC	C1608 JB 1C 104KT-N
C883	4030011600	S.CERAMIC	C1608 JB 1C 104KT-N
C884	4510005310	S.ELECTROLYTIC	ECEV1CA220SR
C901	4510005360	S.ELECTROLYTIC	ECEV1HA4R7SR
C921	4030006880	S.CERAMIC	C1608 JB 1H 472K-T-A
C922	4030006880	S.CERAMIC	C1608 JB 1H 472K-T-A
C1101	4030011600	S.CERAMIC	C1608 JB 1C 104KT-N
C1102	4030011600	S.CERAMIC	C1608 JB 1C 104KT-N
C1103	4030011600	S.CERAMIC	C1608 JB 1C 104KT-N
C1104	4030011600	S.CERAMIC	C1608 JB 1C 104KT-N
C1105	4030011600	S.CERAMIC	C1608 JB 1C 104KT-N
C1106	4030011600	S.CERAMIC	C1608 JB 1C 104KT-N
C1107	4030011600	S.CERAMIC	C1608 JB 1C 104KT-N
C1108	4030011600	S.CERAMIC	C1608 JB 1C 104KT-N
C1109	4030011600	S.CERAMIC	C1608 JB 1C 104KT-N
C1110	4030011600	S.CERAMIC	C1608 JB 1C 104KT-N
C1201	4030011600	S.CERAMIC	C1608 JB 1C 104KT-N
C1211	4030011600	S.CERAMIC	C1608 JB 1C 104KT-N
C1221	4030011600	S.CERAMIC	C1608 JB 1C 104KT-N
C1307	4030011600	S.CERAMIC	C1608 JB 1C 104KT-N
C1308	4030011600	S.CERAMIC	C1608 JB 1C 104KT-N
C1309	4030011600	S.CERAMIC	C1608 JB 1C 104KT-N
C1401	4030011600	S.CERAMIC	C1608 JB 1C 104KT-N
C1402	4030011600	S.CERAMIC	C1608 JB 1C 104KT-N
C1403	4030011600	S.CERAMIC	C1608 JB 1C 104KT-N
C1404	4030011600	S.CERAMIC	C1608 JB 1C 104KT-N
C1405	4030011600	S.CERAMIC	C1608 JB 1C 104KT-N
C1406	4030011600	S.CERAMIC	C1608 JB 1C 104KT-N
C1407	4030011600	S.CERAMIC	C1608 JB 1C 104KT-N
C1408	4030011600	S.CERAMIC	C1608 JB 1C 104KT-N
C1409	4030011600	S.CERAMIC	C1608 JB 1C 104KT-N
C1521	4030011600	S.CERAMIC	C1608 JB 1C 104KT-N
C1522	4030011600	S.CERAMIC	C1608 JB 1C 104KT-N
C1541	4510006650	S.ELECTROLYTIC	ECEV1EA100SR
C1551	4510006650	S.ELECTROLYTIC	ECEV1EA100SR
C1552	4510006650	S.ELECTROLYTIC	ECEV1EA100SR
C1553	4510006650	S.ELECTROLYTIC	ECEV1EA100SR
C1554	4510006650	S.ELECTROLYTIC	ECEV1EA100SR
C1555	4030011600	S.CERAMIC	C1608 JB 1C 104KT-N
C1556	4030011600	S.CERAMIC	C1608 JB 1C 104KT-N
J101	6510003400	CONNECTOR	B04B-EH-S
J120	6510019970	S.CONNECTOR	52808-1090
J201	6510019980	S.CONNECTOR	52808-1690
J221	6510019980	S.CONNECTOR	52808-1690
J241	6510021560	S.CONNECTOR	52808-2490
J301	6510021560	S.CONNECTOR	52808-2490
J321	6510021560	S.CONNECTOR	52808-2490
J322	6510019970	S.CONNECTOR	52808-1090
J451	6510003400	CONNECTOR	B04B-EH-S
J452	6510003390	CONNECTOR	B03B-EH-S
J531	6510021560	S.CONNECTOR	52808-2490
J601	6510019970	S.CONNECTOR	52808-1090
J801	6510018960	S.CONNECTOR	B2B-PH-SM3-TB
J802	6510018960	S.CONNECTOR	B2B-PH-SM3-TB
J921	6510019970	S.CONNECTOR	52808-1090
J941	6510019970	S.CONNECTOR	52808-1090

S.=Surface mount

[DISPLAY BOARD]

REF NO.	ORDER NO.	DESCRIPTION	
DS621	5040002110	S.LED	CL-200HR-C-TU
DS622	5040002080	S.LED	CL-200YG-C-TU
DS623	5040002080	S.LED	CL-200YG-C-TU
DS624	5040002080	S.LED	CL-200YG-C-TU
DS625	5040002080	S.LED	CL-200YG-C-TU
DS901	5040002080	S.LED	CL-200YG-C-TU
DS902	5040002080	S.LED	CL-200YG-C-TU
DS903	5040002080	S.LED	CL-200YG-C-TU
DS904	5040002080	S.LED	CL-200YG-C-TU
S621	2260001890	S.SWITCH	SKQDPA
S622	2260001890	S.SWITCH	SKQDPA
S623	2260001890	S.SWITCH	SKQDPA
S624	2260001890	S.SWITCH	SKQDPA
S625	2260001890	S.SWITCH	SKQDPA
S626	2260001890	S.SWITCH	SKQDPA
W502	7030003860	S.JUMPER	ERJ3GE JPW V
W504	7030003860	S.JUMPER	ERJ3GE JPW V
W506	7030003860	S.JUMPER	ERJ3GE JPW V
W512	7030003860	S.JUMPER	ERJ3GE JPW V
W801	7030008240	S.JUMPER	ERJ12YJ0R00H
EP1	0910051843	PCB	B 5328C

[PHONE BOARD]

REF NO.	ORDER NO.	DESCRIPTION	
L1	6200003950	S.COIL	HF50ACC 322513-T
L2	6200003950	S.COIL	HF50ACC 322513-T
R1	7030008180	S.RESISTOR	ERJ12YJ331H (330 Ω)
R2	7030008180	S.RESISTOR	ERJ12YJ331H (330 Ω)
C1	4030006880	S.CERAMIC	C1608 JB 1H 472K-T-A
C2	4030006880	S.CERAMIC	C1608 JB 1H 472K-T-A
C3	4030006880	S.CERAMIC	C1608 JB 1H 472K-T-A
J1	6510019970	S.CONNECTOR	52808-1090
J2	6450001980	CONNECTOR	HLJ5815-01-030
EP1	0910052281	PCB	B 5331A

[MIC BOARD]

REF NO.	ORDER NO.	DESCRIPTION	
L1	6200003260	S.COIL	NL 322522T-101J
L3	6200003260	S.COIL	NL 322522T-101J
L4	6200003260	S.COIL	NL 322522T-101J
L6	6200003950	S.COIL	HF50ACC 322513-T
C2	4030006880	S.CERAMIC	C1608 JB 1H 472K-T-A
C3	4030006880	S.CERAMIC	C1608 JB 1H 472K-T-A
C4	4030006880	S.CERAMIC	C1608 JB 1H 472K-T-A
C5	4030006880	S.CERAMIC	C1608 JB 1H 472K-T-A
C6	4030006880	S.CERAMIC	C1608 JB 1H 472K-T-A
C7	4030007130	S.CERAMIC	C1608 CH 1H 101J-T-A
J1	6510000190	CONNECTOR	FM214-8SS (P)
J2	6510019970	S.CONNECTOR	52808-1090
EP1	0910052322	PCB	B 5407B

[MODE BOARD]

REF NO.	ORDER NO.	DESCRIPTION	
R1	7030003540	S.RESISTOR	ERJ3GEYJ 682 V (6.8 kΩ)
R2	7030003480	S.RESISTOR	ERJ3GEYJ 222 V (2.2 kΩ)
R3	7030003520	S.RESISTOR	ERJ3GEYJ 472 V (4.7 kΩ)
R4	7030003580	S.RESISTOR	ERJ3GEYJ 153 V (15 kΩ)
R5	7030003540	S.RESISTOR	ERJ3GEYJ 682 V (6.8 kΩ)
R6	7030003480	S.RESISTOR	ERJ3GEYJ 222 V (2.2 kΩ)
R7	7030003520	S.RESISTOR	ERJ3GEYJ 472 V (4.7 kΩ)
C1	4030011600	S.CERAMIC	C1608 JB 1C 104KT-N
C2	4030011600	S.CERAMIC	C1608 JB 1C 104KT-N
J1	6510019980	S.CONNECTOR	52808-1690
S1	2260001890	S.SWITCH	SKQDPA
S2	2260001890	S.SWITCH	SKQDPA
S3	2260001890	S.SWITCH	SKQDPA
S4	2260001890	S.SWITCH	SKQDPA
S5	2260001890	S.SWITCH	SKQDPA
S6	2260001890	S.SWITCH	SKQDPA
S7	2260001890	S.SWITCH	SKQDPA
S8	2260001890	S.SWITCH	SKQDPA
S9	2260001890	S.SWITCH	SKQDPA
S10	2260001890	S.SWITCH	SKQDPA
S11	2260001890	S.SWITCH	SKQDPA
S12	2260001890	S.SWITCH	SKQDPA
S13	2260001890	S.SWITCH	SKQDPA
S14	2260001890	S.SWITCH	SKQDPA
S15	2260001890	S.SWITCH	SKQDPA
S16	2260001890	S.SWITCH	SKQDPA
S17	2260001890	S.SWITCH	SKQDPA
S18	2260001890	S.SWITCH	SKQDPA
EP1	0910052292	PCB	B 5404B

[KEY BOARD]

REF NO.	ORDER NO.	DESCRIPTION	
C1	4030006880	S.CERAMIC	C1608 JB 1H 472K-T-A
C2	4030006880	S.CERAMIC	C1608 JB 1H 472K-T-A
J1	6510019970	S.CONNECTOR	52808-1090
J2	6450001790	CONNECTOR	HLJ7000-01-3010
EP1	0910052310	PCB	B 5406

[PBT BOARD]

REF NO.	ORDER NO.	DESCRIPTION	
R1	7210002970	VARIABLE	RV-314
R3	7030003640	S.RESISTOR	ERJ3GEYJ 473 V (47 kΩ)
R4	7030003640	S.RESISTOR	ERJ3GEYJ 473 V (47 kΩ)
C1	4030006880	S.CERAMIC	C1608 JB 1H 472K-T-A
C2	4030006880	S.CERAMIC	C1608 JB 1H 472K-T-A
J1	6510019970	S.CONNECTOR	52808-1090
S1	2250000410	ENCODER	TP90D96E20-30F-2178-1
EP1	0910051851	PCB	B 5330A

S.=Surface mount

[TEN-KEY BOARD]

REF NO.	ORDER NO.	DESCRIPTION	
Q1	1590002310	S.TRANSISTOR	DTC114EE TL
Q2	1590002310	S.TRANSISTOR	DTC114EE TL
Q3	1590002310	S.TRANSISTOR	DTC114EE TL
Q4	1590002310	S.TRANSISTOR	DTC114EE TL
Q5	1590002310	S.TRANSISTOR	DTC114EE TL
R1	7030003540	S.RESISTOR	ERJ3GEYJ 682 V (6.8 kΩ)
R2	7030003480	S.RESISTOR	ERJ3GEYJ 222 V (2.2 kΩ)
R3	7030003520	S.RESISTOR	ERJ3GEYJ 472 V (4.7 kΩ)
R4	7030003580	S.RESISTOR	ERJ3GEYJ 153 V (15 kΩ)
R5	7030003540	S.RESISTOR	ERJ3GEYJ 682 V (6.8 kΩ)
R6	7030003480	S.RESISTOR	ERJ3GEYJ 222 V (2.2 kΩ)
R7	7030003520	S.RESISTOR	ERJ3GEYJ 472 V (4.7 kΩ)
R8	7030003530	S.RESISTOR	ERJ3GEYJ 562 V (5.6 kΩ)
R9	7030003530	S.RESISTOR	ERJ3GEYJ 562 V (5.6 kΩ)
R10	7030003420	S.RESISTOR	ERJ3GEYJ 681 V (680 Ω)
R11	7030003440	S.RESISTOR	ERJ3GEYJ 102 V (1 kΩ)
R12	7030003440	S.RESISTOR	ERJ3GEYJ 102 V (1 kΩ)
C1	4030011600	S.CERAMIC	C1608 JB 1C 104KT-N
C2	4030011600	S.CERAMIC	C1608 JB 1C 104KT-N
J1	6510019980	S.CONNECTOR	52808-1690
J2	6510021560	S.CONNECTOR	52808-2490
DS1	5040002110	S.LED	CL-200HR-C-TU
DS2	5040002110	S.LED	CL-200HR-C-TU
DS3	5040002220	S.LED	CL-220YG-C-TU
DS4	5040002220	S.LED	CL-220YG-C-TU
DS5	5040002220	S.LED	CL-220YG-C-TU
S1	2260001890	S.SWITCH	SKQDPA
S2	2260001890	S.SWITCH	SKQDPA
S3	2260001890	S.SWITCH	SKQDPA
S4	2260001890	S.SWITCH	SKQDPA
S5	2260001890	S.SWITCH	SKQDPA
S6	2260001890	S.SWITCH	SKQDPA
S7	2260001890	S.SWITCH	SKQDPA
S8	2260001890	S.SWITCH	SKQDPA
S9	2260001890	S.SWITCH	SKQDPA
S10	2260001890	S.SWITCH	SKQDPA
S11	2260001890	S.SWITCH	SKQDPA
S12	2260001890	S.SWITCH	SKQDPA
S13	2260001890	S.SWITCH	SKQDPA
S14	2260001890	S.SWITCH	SKQDPA
S15	2260001890	S.SWITCH	SKQDPA
S16	2260001890	S.SWITCH	SKQDPA
S17	2260001890	S.SWITCH	SKQDPA
S18	2260001890	S.SWITCH	SKQDPA
S19	2260001890	S.SWITCH	SKQDPA
S20	2260001890	S.SWITCH	SKQDPA
S21	2260001890	S.SWITCH	SKQDPA
S22	2260001890	S.SWITCH	SKQDPA
S23	2260001890	S.SWITCH	SKQDPA
S24	2260001890	S.SWITCH	SKQDPA
S25	2260001890	S.SWITCH	SKQDPA
S26	2260001890	S.SWITCH	SKQDPA
S27	2260001890	S.SWITCH	SKQDPA
S28	2260001890	S.SWITCH	SKQDPA
S29	2260001890	S.SWITCH	SKQDPA
S30	2260001890	S.SWITCH	SKQDPA
S31	2260001890	S.SWITCH	SKQDPA
EP1	0910052272	PCB	B 5403B

[RIT BOARD]

REF NO.	ORDER NO.	DESCRIPTION	
J1	6510019970	S.CONNECTOR	52808-1090
S1	2250000340	ENCODER	EVQ-VCJF0324B
EP1	0910052300	PCB	B 5405

[RF UNIT]

REF NO.	ORDER NO.	DESCRIPTION	
IC151	1110001890	S.IC	μPC1678G-E2
IC451	1110003970	S.IC	μPC1658G-E1
IC841	1110003490	S.IC	TA31136FN (D,EL)
IC871	1110003870	S.IC	NJM2058M-T1
IC901	1130007700	S.IC	BU4094BCF-T1
IC902	1130007570	S.IC	BU4094BCFV-E2
IC903	1160000130	S.IC	TD62783AF (TP1)
IC904	1160000130	S.IC	TD62783AF (TP1)
IC961	1110004130	S.IC	μPC2708T-E3
Q131	1590002310	S.TRANSISTOR	DTC114EE TL
Q132	1590002310	S.TRANSISTOR	DTC114EE TL
Q141	1590002710	S.TRANSISTOR	UMH11NTN
Q143	1590002310	S.TRANSISTOR	DTC114EE TL
Q151	1590002710	S.TRANSISTOR	UMH11NTN
Q152	1510000510	S.TRANSISTOR	2SA1576A T106R
Q153	1590002310	S.TRANSISTOR	DTC114EE TL
Q441	1560000720	S.FET	2SK2171-4-TD
Q442	1560000720	S.FET	2SK2171-4-TD
Q501	1560000720	S.FET	2SK2171-4-TD
Q511	1560000640	S.FET	2SK1740-TA
Q512	1560000640	S.FET	2SK1740-TA
Q513	1560000640	S.FET	2SK1740-TA
Q514	1560000640	S.FET	2SK1740-TA
Q531	1530002060	S.TRANSISTOR	2SC4081 T107 R
Q532	1540000550	S.TRANSISTOR	2SD1664 T100Q
Q551	1560000640	S.FET	2SK1740-TA
Q561	1530003150	S.TRANSISTOR	2SC4673D-TD
Q601	1560000720	S.FET	2SK2171-4-TD
Q611	1560000640	S.FET	2SK1740-TA
Q612	1560000640	S.FET	2SK1740-TA
Q613	1560000640	S.FET	2SK1740-TA
Q614	1560000640	S.FET	2SK1740-TA
Q631	1530002060	S.TRANSISTOR	2SC4081 T107 R
Q632	1540000550	S.TRANSISTOR	2SD1664 T100Q
Q651	1560000640	S.FET	2SK1740-TA
Q661	1530003150	S.TRANSISTOR	2SC4673D-TD
Q701	1560000560	S.FET	2SK882-GR (TE85L)
Q721	1580000620	S.FET	3SK131-T2 MAS
Q722	1590002480	S.TRANSISTOR	UMC3N TR
Q751	1560000560	S.FET	2SK882-GR (TE85L)
Q781	1530002060	S.TRANSISTOR	2SC4081 T107 R
Q801	1530002060	S.TRANSISTOR	2SC4081 T107 R
Q811	1560000560	S.FET	2SK882-GR (TE85L)
Q812	1560000560	S.FET	2SK882-GR (TE85L)
Q831	1560000560	S.FET	2SK882-GR (TE85L)
Q901	1590002710	S.TRANSISTOR	UMH11NTN
Q902	1590002710	S.TRANSISTOR	UMH11NTN
Q903	1590002480	S.TRANSISTOR	UMC3N TR
Q904	1590002480	S.TRANSISTOR	UMC3N TR
Q905	1590002480	S.TRANSISTOR	UMC3N TR
Q941	1560000640	S.FET	2SK1740-TA
Q942	1560000640	S.FET	2SK1740-TA
Q943	1560000640	S.FET	2SK1740-TA
Q944	1560000640	S.FET	2SK1740-TA
Q945	1540000550	S.TRANSISTOR	2SD1664 T100Q
D101	1750000300	S.DIODE	1SS302 (TE85R)
D102	1750000300	S.DIODE	1SS302 (TE85R)
D131	1750000450	S.DIODE	1SV265-TL
D141	1750000450	S.DIODE	1SV265-TL
D142	1790000620	S.DIODE	MA77 (TX)
D151	1790001250	S.DIODE	MA2S111-(TX)
D152	1790001250	S.DIODE	MA2S111-(TX)

S.=Surface mount

[RF UNIT]

REF NO.	ORDER NO.	DESCRIPTION	
D191	1750000440	S.DIODE	1SV263-TL
D192	1790000620	S.DIODE	MA77 (TX)
D211	1750000440	S.DIODE	1SV263-TL
D212	1790000620	S.DIODE	MA77 (TX)
D231	1750000450	S.DIODE	1SV265-TL
D232	1790000450	S.DIODE	MA862 (TX)
D271	1750000440	S.DIODE	1SV263-TL
D272	1790000620	S.DIODE	MA77 (TX)
D291	1750000450	S.DIODE	1SV265-TL
D292	1790000450	S.DIODE	MA862 (TX)
D311	1750000440	S.DIODE	1SV263-TL
D312	1790000620	S.DIODE	MA77 (TX)
D331	1750000440	S.DIODE	1SV263-TL
D332	1790000620	S.DIODE	MA77 (TX)
D371	1750000440	S.DIODE	1SV263-TL
D372	1790000620	S.DIODE	MA77 (TX)
D391	1750000440	S.DIODE	1SV263-TL
D392	1790000620	S.DIODE	MA77 (TX)
D421	1790000620	S.DIODE	MA77 (TX)
D431	1790000620	S.DIODE	MA77 (TX)
D432	1790000620	S.DIODE	MA77 (TX)
D441	1790000450	S.DIODE	MA862 (TX)
D442	1790000450	S.DIODE	MA862 (TX)
D481	1790000620	S.DIODE	MA77 (TX)
D531	1750000450	S.DIODE	1SV265-TL
D532	1750000450	S.DIODE	1SV265-TL
D533	1750000440	S.DIODE	1SV263-TL
D534	1790000620	S.DIODE	MA77 (TX)
D535	1790000620	S.DIODE	MA77 (TX)
D536	1790001250	S.DIODE	MA2S111-(TX)
D561	1790000450	S.DIODE	MA862 (TX)
D631	1750000450	S.DIODE	1SV265-TL
D632	1750000450	S.DIODE	1SV265-TL
D633	1750000440	S.DIODE	1SV263-TL
D635	1790000620	S.DIODE	MA77 (TX)
D636	1790001250	S.DIODE	MA2S111-(TX)
D701	1790000450	S.DIODE	MA862 (TX)
D711	1790000450	S.DIODE	MA862 (TX)
D721	1790000450	S.DIODE	MA862 (TX)
D741	1750000430	S.DIODE	HSB88WSTR
D742	1790001620	S.DIODE	1SV308 (TPL3)
D743	1790001620	S.DIODE	1SV308 (TPL3)
D751	1790000620	S.DIODE	MA77 (TX)
D771	1750000430	S.DIODE	HSB88WSTR
D772	1790000620	S.DIODE	MA77 (TX)
D781	1750000450	S.DIODE	1SV265-TL
D782	1750000440	S.DIODE	1SV263-TL
D783	1750000450	S.DIODE	1SV265-TL
D784	1790000950	S.ZENER	MA8056-M (TX)
D801	1750000440	S.DIODE	1SV263-TL
D831	1750000430	S.DIODE	HSB88WSTR
D861	1790001250	S.DIODE	MA2S111-(TX)
D871	1790001560	S.DIODE	1SS372 (TE85R)
D901	1750000520	S.DIODE	DAN222TL
D902	1750000520	S.DIODE	DAN222TL
FI711	2010002470	XTAL	FL-315 (64.45500 MHz)
FI841	2020001500	S.CERAMIC	SFECV13.35MA
FI842	2020001320	CERAMIC	CFJ455K8
FI843	2020001500	S.CERAMIC	SFECV13.35MA
L111	6200003450	S.COIL	NL 322522T-082J
L112	6200001470	S.COIL	NL 322522T-R12J-3
L131	6200005490	S.COIL	NL 322522T-331J
L132	6200002960	S.COIL	NL 322522T-4R7J-3
L141	6200005490	S.COIL	NL 322522T-331J
L151	6200001710	S.COIL	NL 322522T-220J
L152	6200001470	S.COIL	NL 322522T-R12J-3
L171	6200005490	S.COIL	NL 322522T-331J
L172	6200008790	S.COIL	ACL3225S-4R7K
L173	6200008800	S.COIL	ACL3225S-5R6K
L174	6200002960	S.COIL	NL 322522T-4R7J-3
L181	6200005490	S.COIL	NL 322522T-331J
L182	6200002960	S.COIL	NL 322522T-4R7J-3
L183	6200003110	S.COIL	NL 322522T-6R8J
L191	6200005490	S.COIL	NL 322522T-331J
L192	6200003090	S.COIL	NL 322522T-2R7J-3
L193	6200003100	S.COIL	NL 322522T-3R9J-3
L194	6200005490	S.COIL	NL 322522T-331J
L211	6200005490	S.COIL	NL 322522T-331J

[RF UNIT]

REF NO.	ORDER NO.	DESCRIPTION	
L212	6200002990	S.COIL	NL 322522T-2R2J-3
L213	6200003090	S.COIL	NL 322522T-2R7J-3
L214	6200008780	S.COIL	ACL3225S-3R9K
L215	6200008790	S.COIL	ACL3225S-4R7K
L231	6200005490	S.COIL	NL 322522T-331J
L232	6200003070	S.COIL	NL 322522T-1R5J-3
L233	6200002990	S.COIL	NL 322522T-2R2J-3
L234	6200003090	S.COIL	NL 322522T-2R7J-3
L235	6200003100	S.COIL	NL 322522T-3R9J-3
L251	6200003260	S.COIL	NL 322522T-101J
L252	6200003060	S.COIL	NL 322522T-1R2J-3
L253	6200003070	S.COIL	NL 322522T-1R5J-3
L254	6200003070	S.COIL	NL 322522T-1R5J-3
L255	6200003070	S.COIL	NL 322522T-1R5J-3
L271	6200003260	S.COIL	NL 322522T-101J
L272	6200003330	S.COIL	NL 322522T-1R0J-3
L273	6200003060	S.COIL	NL 322522T-1R2J-3
L274	6200003060	S.COIL	NL 322522T-1R2J-3
L275	6200003070	S.COIL	NL 322522T-1R5J-3
L291	6200003260	S.COIL	NL 322522T-101J
L292	6200003060	S.COIL	NL 322522T-1R2J-3
L293	6200003330	S.COIL	NL 322522T-1R0J-3
L294	6200003330	S.COIL	NL 322522T-1R0J-3
L295	6200003080	S.COIL	NL 322522T-1R8J-3
L311	6200003260	S.COIL	NL 322522T-101J
L312	6200003250	S.COIL	NL 322522T-R39J-3
L313	6200002980	S.COIL	NL 322522T-R56J-3
L314	6200003040	S.COIL	NL 322522T-R68J-3
L315	6200003330	S.COIL	NL 322522T-1R0J-3
L331	6200003260	S.COIL	NL 322522T-101J
L332	6200003020	S.COIL	NL 322522T-R33J-3
L333	6200003250	S.COIL	NL 322522T-R39J-3
L334	6200003030	S.COIL	NL 322522T-R47J-3
L335	6200003030	S.COIL	NL 322522T-R47J-3
L351	6200003260	S.COIL	NL 322522T-101J
L352	6200003020	S.COIL	NL 322522T-R33J-3
L353	6200003010	S.COIL	NL 322522T-R27J-3
L354	6200003020	S.COIL	NL 322522T-R33J-3
L355	6200003250	S.COIL	NL 322522T-R39J-3
L371	6200001830	S.COIL	NL 322522T-100J
L372	6200008100	S.COIL	LQN1H R14J04
L373	6200008100	S.COIL	LQN1H R14J04
L374	6200008100	S.COIL	LQN1H R14J04
L375	6200008100	S.COIL	LQN1H R14J04
L376	6200008100	S.COIL	LQN1H R14J04
L391	6200001830	S.COIL	NL 322522T-100J
L393	6200003420	S.COIL	NL 322522T-R15J-3
L394	6200003020	S.COIL	NL 322522T-R33J-3
L395	6200001830	S.COIL	NL 322522T-100J
L411	6200005490	S.COIL	NL 322522T-331J
L412	6200005490	S.COIL	NL 322522T-331J
L413	6200002960	S.COIL	NL 322522T-4R7J-3
L431	6200003220	S.COIL	NL 322522T-151J
L441	6140000640	COIL	LR-86
L442	6200003090	S.COIL	NL 322522T-2R7J-3
L443	6140003550	COIL	LR-397
L444	6200003260	S.COIL	NL 322522T-101J
L445	6200003220	S.COIL	NL 322522T-151J
L451	6200003260	S.COIL	NL 322522T-101J
L452	6200003260	S.COIL	NL 322522T-101J
L453	6200002960	S.COIL	NL 322522T-4R7J-3
L471	6200005490	S.COIL	NL 322522T-331J
L491	6140003530	COIL	LR-395
L501	6200001470	S.COIL	NL 322522T-R12J-3
L502	6200003010	S.COIL	NL 322522T-R27J-3
L503	6200003020	S.COIL	NL 322522T-R33J-3
L504	6200005490	S.COIL	NL 322522T-331J
L505	6200003040	S.COIL	NL 322522T-R68J-3
L506	6180002970	S.COIL	NL 322522T-068J
L511	6140003250	COIL	LR-362
L512	6200003260	S.COIL	NL 322522T-101J
L513	6150002980	COIL	LS-309
L521	6200004940	S.COIL	MLF1608D R27K-T
L522	6200004940	S.COIL	MLF1608D R27K-T
L530	6200003640	S.COIL	MLF1608K 100K-T
L531	6200001830	S.COIL	NL 322522T-100J
L532	6200001830	S.COIL	NL 322522T-100J
L533	6200001830	S.COIL	NL 322522T-100J
L534	6200002970	S.COIL	NL 322522T-121J
L535	6200003640	S.COIL	MLF1608K 100K-T
L551	6200001830	S.COIL	NL 322522T-100J
L552	6200004940	S.COIL	MLF1608D R27K-T

S.=Surface mount

[RF UNIT]

REF NO.	ORDER NO.	DESCRIPTION	
L561	6200003000	S.COIL	NL 322522T-R22J-3
L562	6200003020	S.COIL	NL 322522T-R33J-3
L563	6200001830	S.COIL	NL 322522T-100J
L564	6180002970	S.COIL	NL 322522T-068J
L565	6180002970	S.COIL	NL 322522T-068J
L566	6140003210	S.COIL	LR-358
L567	6180002970	S.COIL	NL 322522T-068J
L568	6200003640	S.COIL	MLF1608K 100K-T
L601	6200001470	S.COIL	NL 322522T-R12J-3
L602	6200003010	S.COIL	NL 322522T-R27J-3
L603	6200003020	S.COIL	NL 322522T-R33J-3
L604	6200005490	S.COIL	NL 322522T-331J
L605	6200003040	S.COIL	NL 322522T-R68J-3
L606	6180002970	S.COIL	NL 322522T-068J
L611	6140003250	COIL	LR-362
L612	6200003260	S.COIL	NL 322522T-101J
L613	6150002980	COIL	LS-309
L621	6200004940	S.COIL	MLF1608D R27K-T
L622	6200004940	S.COIL	MLF1608D R27K-T
L631	6200001830	S.COIL	NL 322522T-100J
L632	6200001830	S.COIL	NL 322522T-100J
L633	6200001830	S.COIL	NL 322522T-100J
L634	6200002970	S.COIL	NL 322522T-121J
L651	6200001830	S.COIL	NL 322522T-100J
L652	6200004940	S.COIL	MLF1608D R27K-T
L653	6140003210	S.COIL	LR-358
L661	6200003000	S.COIL	NL 322522T-R22J-3
L662	6200003020	S.COIL	NL 322522T-R33J-3
L663	6200001830	S.COIL	NL 322522T-100J
L664	6180002970	S.COIL	NL 322522T-068J
L665	6180002970	S.COIL	NL 322522T-068J
L666	6140003210	S.COIL	LR-358
L667	6180002970	S.COIL	NL 322522T-068J
L701	6150004280	COIL	LS-484B
L711	6150002430	COIL	LS-254
L712	6150002430	COIL	LS-254
L713	6150002430	COIL	LS-254
L721	6150004280	COIL	LS-484B
L722	6150004280	COIL	LS-484B
L741	6140003210	S.COIL	LR-358
L742	6140003530	COIL	LR-395
L745	6200005490	S.COIL	NL 322522T-331J
L746	6200005490	S.COIL	NL 322522T-331J
L752	6150004280	COIL	LS-484B
L753	6200004600	S.COIL	MLF1608D R15K-T
L754	6200004600	S.COIL	MLF1608D R15K-T
L755	6200003630	S.COIL	MLF1608D R68K-T
L771	6130002960	S.COIL	617DB-1327=P3
L772	6130002960	S.COIL	617DB-1327=P3
L781	6200001830	S.COIL	NL 322522T-100J
L782	6200001830	S.COIL	NL 322522T-100J
L783	6200001830	S.COIL	NL 322522T-100J
L784	6200001830	S.COIL	NL 322522T-100J
L802	6200003090	S.COIL	NL 322522T-2R7J-3
L812	6150004280	COIL	LS-484B
L813	6150004280	COIL	LS-484B
L831	6140003210	S.COIL	LR-358
L832	6140003210	S.COIL	LR-358
L833	6150004280	COIL	LS-484B
L841	6200003080	S.COIL	NL 322522T-1R8J-3
L842	6200003640	S.COIL	MLF1608K 100K-T
L871	6200003260	S.COIL	NL 322522T-101J
L872	6200003260	S.COIL	NL 322522T-101J
L873	6200003260	S.COIL	NL 322522T-101J
L941	6140003210	S.COIL	LR-358
L942	6140003210	S.COIL	LR-358
L943	6150005050	COIL	LS-532 7QM
L951	6200003950	S.COIL	HF50ACC 322513-T
L961	6200003450	S.COIL	NL 322522T-082J
L962	6200003420	S.COIL	NL 322522T-R15J-3
L963	6200001710	S.COIL	NL 322522T-220J
R111	7030003560	S.RESISTOR	ERJ3GEYJ 103 V (10 kΩ)
R112	7540000130	ABSORBER	2P-50A-301
R121	7030003280	S.RESISTOR	ERJ3GEYJ 470 V (47 Ω)
R122	7030003320	S.RESISTOR	ERJ3GEYJ 101 V (100 Ω)
R123	7030003340	S.RESISTOR	ERJ3GEYJ 151 V (150 Ω)
R124	7030003300	S.RESISTOR	ERJ3GEYJ 680 V (68 Ω)
R131	7030008180	S.RESISTOR	ERJ12YJ331H (330 Ω)
R132	7030003680	S.RESISTOR	ERJ3GEYJ 104 V (100 kΩ)
R133	7030003560	S.RESISTOR	ERJ3GEYJ 103 V (10 kΩ)

[RF UNIT]

REF NO.	ORDER NO.	DESCRIPTION	
R141	7030008180	S.RESISTOR	ERJ12YJ331H (330 Ω)
R142	7030003680	S.RESISTOR	ERJ3GEYJ 104 V (100 kΩ)
R143	7030003480	S.RESISTOR	ERJ3GEYJ 222 V (2.2 kΩ)
R144	7030003560	S.RESISTOR	ERJ3GEYJ 103 V (10 kΩ)
R145	7540000130	ABSORBER	2P-50A-301
R146	7030003560	S.RESISTOR	ERJ3GEYJ 103 V (10 kΩ)
R147	7030003680	S.RESISTOR	ERJ3GEYJ 104 V (100 kΩ)
R151	7030000320	S.RESISTOR	MCR10EZJH 330 Ω (331)
R152	7030003220	S.RESISTOR	ERJ3GEYJ 150 V (15 Ω)
R153	7030000320	S.RESISTOR	MCR10EZJH 330 Ω (331)
R154	7030005150	S.RESISTOR	MCR18EZJH 180 Ω (181)
R155	7030003680	S.RESISTOR	ERJ3GEYJ 104 V (100 kΩ)
R156	7030003560	S.RESISTOR	ERJ3GEYJ 103 V (10 kΩ)
R158	7030004040	S.RESISTOR	ERJ3GEYJ 4R7 V (4.7 Ω)
R159	7030003640	S.RESISTOR	ERJ3GEYJ 473 V (47 kΩ)
R160	7030003440	S.RESISTOR	ERJ3GEYJ 102 V (1 kΩ)
R161	7030003400	S.RESISTOR	ERJ3GEYJ 471 V (470 Ω)
R162	7030003200	S.RESISTOR	ERJ3GEYJ 100 V (10 Ω)
R163	7030003400	S.RESISTOR	ERJ3GEYJ 150 V (15 Ω)
R171	7030003680	S.RESISTOR	ERJ3GEYJ 104 V (100 kΩ)
R181	7030003320	S.RESISTOR	ERJ3GEYJ 101 V (100 Ω)
R182	7030003300	S.RESISTOR	ERJ3GEYJ 680 V (68 Ω)
R183	7030003320	S.RESISTOR	ERJ3GEYJ 101 V (100 Ω)
R184	7030003280	S.RESISTOR	ERJ3GEYJ 470 V (47 Ω)
R191	7030000260	S.RESISTOR	MCR10EZJH 100 Ω (101)
R211	7030000260	S.RESISTOR	MCR10EZJH 100 Ω (101)
R231	7030000260	S.RESISTOR	MCR10EZJH 100 Ω (101)
R251	7030000260	S.RESISTOR	MCR10EZJH 100 Ω (101)
R271	7030000260	S.RESISTOR	MCR10EZJH 100 Ω (101)
R291	7030000260	S.RESISTOR	MCR10EZJH 100 Ω (101)
R311	7030000260	S.RESISTOR	MCR10EZJH 100 Ω (101)
R331	7030000260	S.RESISTOR	MCR10EZJH 100 Ω (101)
R351	7030000260	S.RESISTOR	MCR10EZJH 100 Ω (101)
R371	7030000260	S.RESISTOR	MCR10EZJH 100 Ω (101)
R391	7030000260	S.RESISTOR	MCR10EZJH 100 Ω (101)
R411	7030008180	S.RESISTOR	ERJ12YJ331H (330 Ω)
R412	7030009220	S.RESISTOR	ERJ12YJ561H (560 Ω)
R431	7030003280	S.RESISTOR	ERJ3GEYJ 470 V (47 Ω)
R432	7030003280	S.RESISTOR	ERJ3GEYJ 470 V (47 Ω)
R441	7030003280	S.RESISTOR	ERJ3GEYJ 470 V (47 Ω)
R442	7030000180	S.RESISTOR	MCR10EZJH 22 Ω (220)
R443	7030000180	S.RESISTOR	MCR10EZJH 22 Ω (220)
R444	7030003280	S.RESISTOR	ERJ3GEYJ 470 V (47 Ω)
R451	7030003280	S.RESISTOR	ERJ3GEYJ 470 V (47 Ω)
R452	7030003420	S.RESISTOR	ERJ3GEYJ 681 V (680 Ω)
R453	7030003320	S.RESISTOR	ERJ3GEYJ 101 V (100 Ω)
R454	7030003340	S.RESISTOR	ERJ3GEYJ 151 V (150 Ω)
R455	7030003270	S.RESISTOR	ERJ3GEYJ 390 V (39 Ω)
R456	7030003340	S.RESISTOR	ERJ3GEYJ 151 V (150 Ω)
R471	7030009220	S.RESISTOR	ERJ12YJ561H (560 Ω)
R481	7030003640	S.RESISTOR	ERJ3GEYJ 473 V (47 kΩ)
R482	7030003480	S.RESISTOR	ERJ3GEYJ 222 V (2.2 kΩ)
R491	7030003360	S.RESISTOR	ERJ3GEYJ 221 V (220 Ω)
R501	7030003360	S.RESISTOR	ERJ3GEYJ 221 V (220 Ω)
R512	7030003440	S.RESISTOR	ERJ3GEYJ 102 V (1 kΩ)
R513	7030003440	S.RESISTOR	ERJ3GEYJ 102 V (1 kΩ)
R516	7310002720	S.TRIMMER	RV-148 (472)
R522	7030000220	S.RESISTOR	MCR10EZJH 47 Ω (470)
R531	7030003360	S.RESISTOR	ERJ3GEYJ 221 V (220 Ω)
R532	7030003460	S.RESISTOR	ERJ3GEYJ 152 V (1.5 kΩ)
R533	7030003440	S.RESISTOR	ERJ3GEYJ 102 V (1 kΩ)
R534	7030003480	S.RESISTOR	ERJ3GEYJ 222 V (2.2 kΩ)
R535	7030003560	S.RESISTOR	ERJ3GEYJ 103 V (10 kΩ)
R537	7030003480	S.RESISTOR	ERJ3GEYJ 222 V (2.2 kΩ)
R538	7030003280	S.RESISTOR	ERJ3GEYJ 470 V (47 Ω)
R539	7030003480	S.RESISTOR	ERJ3GEYJ 222 V (2.2 kΩ)
R551	7030003360	S.RESISTOR	ERJ3GEYJ 221 V (220 Ω)
R553	7030003480	S.RESISTOR	ERJ3GEYJ 222 V (2.2 kΩ)
R561	7030003300	S.RESISTOR	ERJ3GEYJ 680 V (68 Ω)
R563	7030003620	S.RESISTOR	ERJ3GEYJ 333 V (33 kΩ)
R565	7030001140	S.RESISTOR	MCR50ZJH 120 Ω (121)
R566	7030003360	S.RESISTOR	ERJ3GEYJ 221 V (220 Ω)
R567	7030003440	S.RESISTOR	ERJ3GEYJ 102 V (1 kΩ)
R578	7030003440	S.RESISTOR	ERJ3GEYJ 102 V (1 kΩ)
R601	7030003360	S.RESISTOR	ERJ3GEYJ 221 V (220 Ω)
R612	7030003440	S.RESISTOR	ERJ3GEYJ 102 V (1 kΩ)
R613	7030003440	S.RESISTOR	ERJ3GEYJ 102 V (1 kΩ)
R616	7310002720	S.TRIMMER	RV-148 (472)
R622	7030000220	S.RESISTOR	MCR10EZJH 47 Ω (470)
R631	7030003360	S.RESISTOR	ERJ3GEYJ 221 V (220 Ω)
R632	7030003460	S.RESISTOR	ERJ3GEYJ 152 V (1.5 kΩ)
R633	7030003440	S.RESISTOR	ERJ3GEYJ 102 V (1 kΩ)

S.=Surface mount

[RF UNIT]

REF NO.	ORDER NO.	DESCRIPTION	
R634	7030003480	S.RESISTOR	ERJ3GEYJ 222 V (2.2 kΩ)
R635	7030003560	S.RESISTOR	ERJ3GEYJ 103 V (10 kΩ)
R637	7030003280	S.RESISTOR	ERJ3GEYJ 470 V (47 Ω)
R638	7030003340	S.RESISTOR	ERJ3GEYJ 151 V (150 Ω)
R651	7030003360	S.RESISTOR	ERJ3GEYJ 221 V (220 Ω)
R653	7030003480	S.RESISTOR	ERJ3GEYJ 222 V (2.2 kΩ)
R661	7030003300	S.RESISTOR	ERJ3GEYJ 680 V (68 Ω)
R663	7030003620	S.RESISTOR	ERJ3GEYJ 333 V (33 kΩ)
R665	7030001140	S.RESISTOR	MCR50JZHJ 120 Ω (121)
R666	7030003360	S.RESISTOR	ERJ3GEYJ 221 V (220 Ω)
R701	7030003440	S.RESISTOR	ERJ3GEYJ 102 V (1 kΩ)
R702	7030003320	S.RESISTOR	ERJ3GEYJ 101 V (100 Ω)
R704	7030003680	S.RESISTOR	ERJ3GEYJ 104 V (100 kΩ)
R705	7030003380	S.RESISTOR	ERJ3GEYJ 331 V (330 Ω)
R706	7030003220	S.RESISTOR	ERJ3GEYJ 150 V (15 Ω)
R707	7030003380	S.RESISTOR	ERJ3GEYJ 331 V (330 Ω)
R708	7030003440	S.RESISTOR	ERJ3GEYJ 102 V (1 kΩ)
R711	7030003470	S.RESISTOR	ERJ3GEYJ 182 V (1.8 kΩ)
R712	7030003440	S.RESISTOR	ERJ3GEYJ 102 V (1 kΩ)
R721	7030003440	S.RESISTOR	ERJ3GEYJ 102 V (1 kΩ)
R722	7030003470	S.RESISTOR	ERJ3GEYJ 182 V (1.8 kΩ)
R723	7030003590	S.RESISTOR	ERJ3GEYJ 183 V (18 kΩ)
R724	7030003200	S.RESISTOR	ERJ3GEYJ 100 V (10 Ω)
R726	7030003280	S.RESISTOR	ERJ3GEYJ 470 V (47 Ω)
R727	7030003560	S.RESISTOR	ERJ3GEYJ 103 V (10 kΩ)
R728	7030003340	S.RESISTOR	ERJ3GEYJ 151 V (150 Ω)
R730	7030003280	S.RESISTOR	ERJ3GEYJ 470 V (47 Ω)
R733	7030003220	S.RESISTOR	ERJ3GEYJ 150 V (15 Ω)
R734	7030003380	S.RESISTOR	ERJ3GEYJ 331 V (330 Ω)
R735	7030003380	S.RESISTOR	ERJ3GEYJ 331 V (330 Ω)
R736	7030003440	S.RESISTOR	ERJ3GEYJ 102 V (1 kΩ)
R741	7030003380	S.RESISTOR	ERJ3GEYJ 331 V (330 Ω)
R742	7030003220	S.RESISTOR	ERJ3GEYJ 150 V (15 Ω)
R743	7030003380	S.RESISTOR	ERJ3GEYJ 331 V (330 Ω)
R744	7030003440	S.RESISTOR	ERJ3GEYJ 102 V (1 kΩ)
R746	7030000340	S.RESISTOR	MCR10EZHZJ 470 Ω (471)
R751	7030003440	S.RESISTOR	ERJ3GEYJ 102 V (1 kΩ)
R752	7030003440	S.RESISTOR	ERJ3GEYJ 102 V (1 kΩ)
R753	7030003340	S.RESISTOR	ERJ3GEYJ 151 V (150 Ω)
R755	7030003320	S.RESISTOR	ERJ3GEYJ 101 V (100 Ω)
R756	7030003480	S.RESISTOR	ERJ3GEYJ 222 V (2.2 kΩ)
R758	7030004040	S.RESISTOR	ERJ3GEYJ 4R7 V (4.7 Ω)
R759	7030003480	S.RESISTOR	ERJ3GEYJ 222 V (2.2 kΩ)
R760	7030003290	S.RESISTOR	ERJ3GEYJ 560 V (56 Ω)
R771	7030003350	S.RESISTOR	ERJ3GEYJ 181 V (180 Ω)
R772	7030003260	S.RESISTOR	ERJ3GEYJ 330 V (33 Ω)
R773	7030003350	S.RESISTOR	ERJ3GEYJ 181 V (180 Ω)
R774	7030003430	S.RESISTOR	ERJ3GEYJ 821 V (820 Ω)
R781	7030003440	S.RESISTOR	ERJ3GEYJ 102 V (1 kΩ)
R782	7030003360	S.RESISTOR	ERJ3GEYJ 221 V (220 Ω)
R784	7030003520	S.RESISTOR	ERJ3GEYJ 472 V (4.7 kΩ)
R785	7030003450	S.RESISTOR	ERJ3GEYJ 122 V (1.2 kΩ)
R786	7030003440	S.RESISTOR	ERJ3GEYJ 102 V (1 kΩ)
R787	7030003440	S.RESISTOR	ERJ3GEYJ 102 V (1 kΩ)
R788	7030003560	S.RESISTOR	ERJ3GEYJ 103 V (10 kΩ)
R789	7030003380	S.RESISTOR	ERJ3GEYJ 331 V (330 Ω)
R803	7030003560	S.RESISTOR	ERJ3GEYJ 103 V (10 kΩ)
R804	7030003440	S.RESISTOR	ERJ3GEYJ 102 V (1 kΩ)
R806	7030003560	S.RESISTOR	ERJ3GEYJ 103 V (10 kΩ)
R807	7030003440	S.RESISTOR	ERJ3GEYJ 102 V (1 kΩ)
R808	7030003340	S.RESISTOR	ERJ3GEYJ 151 V (150 Ω)
R811	7030003520	S.RESISTOR	ERJ3GEYJ 472 V (4.7 kΩ)
R812	7030003340	S.RESISTOR	ERJ3GEYJ 151 V (150 Ω)
R813	7030003280	S.RESISTOR	ERJ3GEYJ 470 V (47 Ω)
R814	7030003420	S.RESISTOR	ERJ3GEYJ 681 V (680 Ω)
R815	7030003340	S.RESISTOR	ERJ3GEYJ 151 V (150 Ω)
R818	7030003280	S.RESISTOR	ERJ3GEYJ 470 V (47 Ω)
R819	7030003380	S.RESISTOR	ERJ3GEYJ 331 V (330 Ω)
R820	7030003220	S.RESISTOR	ERJ3GEYJ 150 V (15 Ω)
R821	7030003380	S.RESISTOR	ERJ3GEYJ 331 V (330 Ω)
R831	7030003380	S.RESISTOR	ERJ3GEYJ 331 V (330 Ω)
R832	7030003220	S.RESISTOR	ERJ3GEYJ 150 V (15 Ω)
R833	7030003380	S.RESISTOR	ERJ3GEYJ 331 V (330 Ω)
R834	7030003320	S.RESISTOR	ERJ3GEYJ 101 V (100 Ω)
R835	7030003280	S.RESISTOR	ERJ3GEYJ 470 V (47 Ω)
R841	7030003280	S.RESISTOR	ERJ3GEYJ 470 V (47 Ω)
R845	7030003680	S.RESISTOR	ERJ3GEYJ 104 V (100 kΩ)
R846	7030003360	S.RESISTOR	ERJ3GEYJ 221 V (220 Ω)
R847	7030003360	S.RESISTOR	ERJ3GEYJ 221 V (220 Ω)
R848	7030003440	S.RESISTOR	ERJ3GEYJ 102 V (1 kΩ)
R861	7030003760	S.RESISTOR	ERJ3GEYJ 474 V (470 kΩ)
R862	7030003840	S.RESISTOR	ERJ3GEYJ 225 V (2.2 MΩ)

[RF UNIT]

REF NO.	ORDER NO.	DESCRIPTION	
R863	7310002580	S.TRIMMER	RV-108 (104)
R864	7030003700	S.RESISTOR	ERJ3GEYJ 154 V (150 kΩ)
R865	7030003480	S.RESISTOR	ERJ3GEYJ 222 V (2.2 kΩ)
R866	7030003800	S.RESISTOR	ERJ3GEYJ 105 V (1 MΩ)
R871	7030003580	S.RESISTOR	ERJ3GEYJ 153 V (15 kΩ)
R872	7310002590	S.TRIMMER	RV-109 (222)
R873	7030003680	S.RESISTOR	ERJ3GEYJ 104 V (100 kΩ)
R874	7030003750	S.RESISTOR	ERJ3GEYJ 394 V (390 kΩ)
R875	7030003670	S.RESISTOR	ERJ3GEYJ 823 V (82 kΩ)
R876	7030003440	S.RESISTOR	ERJ3GEYJ 102 V (1 kΩ)
R881	7030003700	S.RESISTOR	ERJ3GEYJ 154 V (150 kΩ)
R882	7030003760	S.RESISTOR	ERJ3GEYJ 474 V (470 kΩ)
R883	7030003700	S.RESISTOR	ERJ3GEYJ 154 V (150 kΩ)
R884	7030003760	S.RESISTOR	ERJ3GEYJ 474 V (470 kΩ)
R901	7030003520	S.RESISTOR	ERJ3GEYJ 472 V (4.7 kΩ)
R902	7030003520	S.RESISTOR	ERJ3GEYJ 472 V (4.7 kΩ)
R905	7030003560	S.RESISTOR	ERJ3GEYJ 103 V (10 kΩ)
R906	7030003560	S.RESISTOR	ERJ3GEYJ 103 V (10 kΩ)
R907	7030003560	S.RESISTOR	ERJ3GEYJ 103 V (10 kΩ)
R908	7030003560	S.RESISTOR	ERJ3GEYJ 103 V (10 kΩ)
R909	7030003560	S.RESISTOR	ERJ3GEYJ 103 V (10 kΩ)
R910	7030003560	S.RESISTOR	ERJ3GEYJ 103 V (10 kΩ)
R911	7030003560	S.RESISTOR	ERJ3GEYJ 103 V (10 kΩ)
R912	7030003560	S.RESISTOR	ERJ3GEYJ 103 V (10 kΩ)
R913	7030003200	S.RESISTOR	ERJ3GEYJ 100 V (10 Ω)
R914	7030003200	S.RESISTOR	ERJ3GEYJ 100 V (10 Ω)
R915	7030003200	S.RESISTOR	ERJ3GEYJ 100 V (10 Ω)
R916	7030003200	S.RESISTOR	ERJ3GEYJ 100 V (10 Ω)
R917	7030003200	S.RESISTOR	ERJ3GEYJ 100 V (10 Ω)
R918	7030003200	S.RESISTOR	ERJ3GEYJ 100 V (10 Ω)
R919	7030003200	S.RESISTOR	ERJ3GEYJ 100 V (10 Ω)
R920	7030003200	S.RESISTOR	ERJ3GEYJ 100 V (10 Ω)
R921	7030003560	S.RESISTOR	ERJ3GEYJ 103 V (10 kΩ)
R922	7030003560	S.RESISTOR	ERJ3GEYJ 103 V (10 kΩ)
R923	7030003560	S.RESISTOR	ERJ3GEYJ 103 V (10 kΩ)
R924	7030003560	S.RESISTOR	ERJ3GEYJ 103 V (10 kΩ)
R927	7030003200	S.RESISTOR	ERJ3GEYJ 100 V (10 Ω)
R928	7030003200	S.RESISTOR	ERJ3GEYJ 100 V (10 Ω)
R929	7030003200	S.RESISTOR	ERJ3GEYJ 100 V (10 Ω)
R930	7030003200	S.RESISTOR	ERJ3GEYJ 100 V (10 Ω)
R933	7030003560	S.RESISTOR	ERJ3GEYJ 103 V (10 kΩ)
R934	7030003560	S.RESISTOR	ERJ3GEYJ 103 V (10 kΩ)
R935	7030003680	S.RESISTOR	ERJ3GEYJ 104 V (100 kΩ)
R936	7030003680	S.RESISTOR	ERJ3GEYJ 104 V (100 kΩ)
R941	7030003400	S.RESISTOR	ERJ3GEYJ 471 V (470 Ω)
R943	7030003400	S.RESISTOR	ERJ3GEYJ 471 V (470 Ω)
R944	7030003440	S.RESISTOR	ERJ3GEYJ 102 V (1 kΩ)
R946	7030003280	S.RESISTOR	ERJ3GEYJ 470 V (47 Ω)
R947	7030003360	S.RESISTOR	ERJ3GEYJ 221 V (220 Ω)
R961	7030003200	S.RESISTOR	ERJ3GEYJ 100 V (10 Ω)
R962	7030003340	S.RESISTOR	ERJ3GEYJ 151 V (150 Ω)
R963	7030003340	S.RESISTOR	ERJ3GEYJ 151 V (150 Ω)
R964	7030003270	S.RESISTOR	ERJ3GEYJ 390 V (39 Ω)
R965	7030003320	S.RESISTOR	ERJ3GEYJ 101 V (100 Ω)
R966	7030003320	S.RESISTOR	ERJ3GEYJ 101 V (100 Ω)
C101	4030006880	S.CERAMIC	C1608 JB 1H 472K-T-A
C111	4030011600	S.CERAMIC	C1608 JB 1C 104KT-N
C112	4030007070	S.CERAMIC	C1608 CH 1H 330J-T-A
C113	4030011540	S.CERAMIC	C1608 CH 1H 750J-T-A
C114	4030007120	S.CERAMIC	C1608 CH 1H 820J-T-A
C115	4030007030	S.CERAMIC	C1608 CH 1H 150J-T-A
C116	4030007090	S.CERAMIC	C1608 CH 1H 470J-T-A
C121	4030006880	S.CERAMIC	C1608 JB 1H 472K-T-A
C122	4030006880	S.CERAMIC	C1608 JB 1H 472K-T-A
C131	4030011600	S.CERAMIC	C1608 JB 1C 104KT-N
C132	4030011600	S.CERAMIC	C1608 JB 1C 104KT-N
C133	4030011600	S.CERAMIC	C1608 JB 1C 104KT-N
C141	4030011600	S.CERAMIC	C1608 JB 1C 104KT-N
C142	4030011600	S.CERAMIC	C1608 JB 1C 104KT-N
C143	4030011600	S.CERAMIC	C1608 JB 1C 104KT-N
C144	4030011600	S.CERAMIC	C1608 JB 1C 104KT-N
C145	4030011600	S.CERAMIC	C1608 JB 1C 104KT-N
C151	4030011600	S.CERAMIC	C1608 JB 1C 104KT-N
C152	4030011600	S.CERAMIC	C1608 JB 1C 104KT-N
C153	4030011600	S.CERAMIC	C1608 JB 1C 104KT-N
C154	4030011600	S.CERAMIC	C1608 JB 1C 104KT-N
C155	4030007120	S.CERAMIC	C1608 CH 1H 820J-T-A
C156	4030007020	S.CERAMIC	C1608 CH 1H 120J-T-A
C157	4030007120	S.CERAMIC	C1608 CH 1H 820J-T-A
C158	4030011600	S.CERAMIC	C1608 JB 1C 104KT-N

S.=Surface mount

[RF UNIT]

REF NO.	ORDER NO.	DESCRIPTION
C171	4030008470	S.CERAMIC C1608 JB 1H 272K-T-A
C172	4030009880	S.CERAMIC C1608 JB 1H 682K-T-A
C173	4030009980	S.CERAMIC C1608 JB 1H 152K-T-A
C174	4030011600	S.CERAMIC C1608 JB 1C 104KT-N
C181	4030011600	S.CERAMIC C1608 JB 1C 104KT-N
C182	4030008650	S.CERAMIC C1608 JB 1H 332K-T-A
C183	4030011330	S.CERAMIC C1608 CH 1H 391J-T-A
C184	4030008650	S.CERAMIC C1608 JB 1H 332K-T-A
C185	4030011600	S.CERAMIC C1608 JB 1C 104KT-N
C186	4030011600	S.CERAMIC C1608 JB 1C 104KT-N
C191	4030011600	S.CERAMIC C1608 JB 1C 104KT-N
C192	4030011600	S.CERAMIC C1608 JB 1C 104KT-N
C193	4030006860	S.CERAMIC C1608 JB 1H 102K-T-A
C194	4030009580	S.CERAMIC C1608 JB 1H 681K-T-A
C195	4030006870	S.CERAMIC C1608 JB 1H 222K-T-A
C196	4030007170	S.CERAMIC C1608 CH 1H 221J-T-A
C197	4030010020	S.CERAMIC C1608 JB 1H 122K-T-A
C198	4030011600	S.CERAMIC C1608 JB 1C 104KT-N
C211	4030011600	S.CERAMIC C1608 JB 1C 104KT-N
C212	4030010020	S.CERAMIC C1608 JB 1H 122K-T-A
C213	4030010750	S.CERAMIC C1608 CH 1H 201J-T-A
C214	4030010040	S.CERAMIC C1608 JB 1H 561K-T-A
C215	4030006870	S.CERAMIC C1608 JB 1H 222K-T-A
C216	4030006900	S.CERAMIC C1608 JB 1E 103K-T-A
C217	4030010020	S.CERAMIC C1608 JB 1H 122K-T-A
C218	4030011600	S.CERAMIC C1608 JB 1C 104KT-N
C231	4030011600	S.CERAMIC C1608 JB 1C 104KT-N
C232	4030010020	S.CERAMIC C1608 JB 1H 122K-T-A
C233	4030007140	S.CERAMIC C1608 CH 1H 121J-T-A
C234	4030009580	S.CERAMIC C1608 JB 1H 681K-T-A
C235	4030008650	S.CERAMIC C1608 JB 1H 332K-T-A
C236	4030008770	S.CERAMIC C1608 JB 1H 562K-T-A
C237	4030006860	S.CERAMIC C1608 JB 1H 102K-T-A
C238	4030011600	S.CERAMIC C1608 JB 1C 104KT-N
C251	4030011600	S.CERAMIC C1608 JB 1C 104KT-N
C252	4030009490	S.CERAMIC C1608 JB 1H 821K-T-A
C253	4030007120	S.CERAMIC C1608 CH 1H 820J-T-A
C254	4030011340	S.CERAMIC C1608 CH 1H 471J-T-A
C255	4030006860	S.CERAMIC C1608 JB 1H 102K-T-A
C256	4030008770	S.CERAMIC C1608 JB 1H 562K-T-A
C257	4030010040	S.CERAMIC C1608 JB 1H 561K-T-A
C258	4030011600	S.CERAMIC C1608 JB 1C 104KT-N
C271	4030011600	S.CERAMIC C1608 JB 1C 104KT-N
C272	4030010040	S.CERAMIC C1608 JB 1H 561K-T-A
C273	4030007110	S.CERAMIC C1608 CH 1H 680J-T-A
C274	4030010760	S.CERAMIC C1608 CH 1H 331J-T-A
C275	4030009580	S.CERAMIC C1608 JB 1H 681K-T-A
C276	4030010770	S.CERAMIC C1608 JB 1H 392K-T-A
C277	4030011330	S.CERAMIC C1608 CH 1H 391J-T-A
C278	4030011600	S.CERAMIC C1608 JB 1C 104KT-N
C291	4030011600	S.CERAMIC C1608 JB 1C 104KT-N
C292	4030010760	S.CERAMIC C1608 CH 1H 331J-T-A
C293	4030007090	S.CERAMIC C1608 CH 1H 470J-T-A
C294	4030007160	S.CERAMIC C1608 CH 1H 181J-T-A
C295	4030010040	S.CERAMIC C1608 JB 1H 561K-T-A
C296	4030008470	S.CERAMIC C1608 JB 1H 272K-T-A
C297	4030010760	S.CERAMIC C1608 CH 1H 331J-T-A
C298	4030011600	S.CERAMIC C1608 JB 1C 104KT-N
C311	4030011600	S.CERAMIC C1608 JB 1C 104KT-N
C312	4030011280	S.CERAMIC C1608 CH 1H 271J-T-A
C313	4030007090	S.CERAMIC C1608 CH 1H 470J-T-A
C314	4030007150	S.CERAMIC C1608 CH 1H 151J-T-A
C315	4030011340	S.CERAMIC C1608 CH 1H 471J-T-A
C316	4030010020	S.CERAMIC C1608 JB 1H 122K-T-A
C317	4030011840	S.CERAMIC C1608 CH 1H 241J-T-A
C318	4030011600	S.CERAMIC C1608 JB 1C 104KT-N
C331	4030011600	S.CERAMIC C1608 JB 1C 104KT-N
C332	4030007160	S.CERAMIC C1608 CH 1H 181J-T-A
C333	4030008560	S.CERAMIC C1608 CH 1H 300J-T-A
C334	4030007130	S.CERAMIC C1608 CH 1H 101J-T-A
C335	4030011830	S.CERAMIC C1608 CH 1H 301J-T-A
C336	4030010020	S.CERAMIC C1608 JB 1H 122K-T-A
C337	4030007150	S.CERAMIC C1608 CH 1H 151J-T-A
C338	4030011600	S.CERAMIC C1608 JB 1C 104KT-N
C351	4030011600	S.CERAMIC C1608 JB 1C 104KT-N
C352	4030006990	S.CERAMIC C1608 CH 1H 080D-T-A
C353	4030007160	S.CERAMIC C1608 CH 1H 181J-T-A
C354	4030007060	S.CERAMIC C1608 CH 1H 270J-T-A
C355	4030007130	S.CERAMIC C1608 CH 1H 101J-T-A
C356	4030007160	S.CERAMIC C1608 CH 1H 181J-T-A
C357	4030010020	S.CERAMIC C1608 JB 1H 122K-T-A
C358	4030007130	S.CERAMIC C1608 CH 1H 101J-T-A

[RF UNIT]

REF NO.	ORDER NO.	DESCRIPTION
C359	4030011600	S.CERAMIC C1608 JB 1C 104KT-N
C371	4030006880	S.CERAMIC C1608 JB 1H 472K-T-A
C372	4030007110	S.CERAMIC C1608 CH 1H 680J-T-A
C373	4030008560	S.CERAMIC C1608 CH 1H 300J-T-A
C374	4030011540	S.CERAMIC C1608 CH 1H 750J-T-A
C375	4030007040	S.CERAMIC C1608 CH 1H 180J-T-A
C376	4030007080	S.CERAMIC C1608 CH 1H 390J-T-A
C377	4030007110	S.CERAMIC C1608 CH 1H 680J-T-A
C378	4030011330	S.CERAMIC C1608 CH 1H 391J-T-A
C379	4030007090	S.CERAMIC C1608 CH 1H 470J-T-A
C380	4030006880	S.CERAMIC C1608 JB 1H 472K-T-A
C391	4030006880	S.CERAMIC C1608 JB 1H 472K-T-A
C393	4030007110	S.CERAMIC C1608 CH 1H 680J-T-A
C394	4030007040	S.CERAMIC C1608 CH 1H 180J-T-A
C395	4030007110	S.CERAMIC C1608 CH 1H 680J-T-A
C396	4030007120	S.CERAMIC C1608 CH 1H 820J-T-A
C397	4030010040	S.CERAMIC C1608 JB 1H 561K-T-A
C398	4030007120	S.CERAMIC C1608 CH 1H 820J-T-A
C399	4030006880	S.CERAMIC C1608 JB 1H 472K-T-A
C411	4030011600	S.CERAMIC C1608 JB 1C 104KT-N
C431	4030011600	S.CERAMIC C1608 JB 1C 104KT-N
C432	4030011600	S.CERAMIC C1608 JB 1C 104KT-N
C441	4030011600	S.CERAMIC C1608 JB 1C 104KT-N
C442	4030011600	S.CERAMIC C1608 JB 1C 104KT-N
C443	4030011600	S.CERAMIC C1608 JB 1C 104KT-N
C444	4030011600	S.CERAMIC C1608 JB 1C 104KT-N
C445	4030011600	S.CERAMIC C1608 JB 1C 104KT-N
C446	4510006670	S.ELECTROLYTIC ECEV1CA471P
C447	4030012610	S.CERAMIC C2012 JB 1C 474K-T-A
C451	4030011600	S.CERAMIC C1608 JB 1C 104KT-N
C452	4030011600	S.CERAMIC C1608 JB 1C 104KT-N
C453	4030011600	S.CERAMIC C1608 JB 1C 104KT-N
C454	4030011600	S.CERAMIC C1608 JB 1C 104KT-N
C455	4030011600	S.CERAMIC C1608 JB 1C 104KT-N
C456	4030011600	S.CERAMIC C1608 JB 1C 104KT-N
C457	4030011600	S.CERAMIC C1608 JB 1C 104KT-N
C481	4030007170	S.CERAMIC C1608 CH 1H 221J-T-A
C491	4030011600	S.CERAMIC C1608 JB 1C 104KT-N
C501	4030007070	S.CERAMIC C1608 CH 1H 330J-T-A
C502	4030007040	S.CERAMIC C1608 CH 1H 180J-T-A
C503	4030007080	S.CERAMIC C1608 CH 1H 390J-T-A
C504	4030011770	S.CERAMIC C1608 CH 1H 060B-T-A
C505	4030007050	S.CERAMIC C1608 CH 1H 220J-T-A
C506	4030011600	S.CERAMIC C1608 JB 1C 104KT-N
C507	4030011770	S.CERAMIC C1608 CH 1H 060B-T-A
C508	4030007000	S.CERAMIC C1608 CH 1H 090D-T-A
C509	4030007070	S.CERAMIC C1608 CH 1H 330J-T-A
C510	4030007040	S.CERAMIC C1608 CH 1H 180J-T-A
C511	4030011600	S.CERAMIC C1608 JB 1C 104KT-N
C513	4030011600	S.CERAMIC C1608 JB 1C 104KT-N
C514	4030011600	S.CERAMIC C1608 JB 1C 104KT-N
C516	4030009510	S.CERAMIC C1608 CH 1H 010B-T-A
C517	4030011600	S.CERAMIC C1608 JB 1C 104KT-N
C521	4030007070	S.CERAMIC C1608 CH 1H 330J-T-A
C522	4030009920	S.CERAMIC C1608 CH 1H 050B-T-A
C523	4030007060	S.CERAMIC C1608 CH 1H 270J-T-A
C531	4030011600	S.CERAMIC C1608 JB 1C 104KT-N
C532	4030011340	S.CERAMIC C1608 CH 1H 471J-T-A
C533	4030006880	S.CERAMIC C1608 JB 1H 472K-T-A
C534	4030011340	S.CERAMIC C1608 CH 1H 471J-T-A
C535	4030006880	S.CERAMIC C1608 JB 1H 472K-T-A
C536	4030006880	S.CERAMIC C1608 JB 1H 472K-T-A
C537	4030006880	S.CERAMIC C1608 JB 1H 472K-T-A
C538	4030011600	S.CERAMIC C1608 JB 1C 104KT-N
C539	4030011600	S.CERAMIC C1608 JB 1C 104KT-N
C540	4510004630	S.ELECTROLYTIC ECEV1CA100SR
C541	4030006880	S.CERAMIC C1608 JB 1H 472K-T-A
C542	4030006880	S.CERAMIC C1608 JB 1H 472K-T-A
C551	4030011600	S.CERAMIC C1608 JB 1C 104KT-N
C552	4030007040	S.CERAMIC C1608 CH 1H 180J-T-A
C553	4510004630	S.ELECTROLYTIC ECEV1CA100SR
C555	4540000020	S.TRIMMER TZVY22060A110
C556	4030011600	S.CERAMIC C1608 JB 1C 104KT-N
C561	4030007080	S.CERAMIC C1608 CH 1H 390J-T-A
C563	4030011600	S.CERAMIC C1608 JB 1C 104KT-N
C564	4030006860	S.CERAMIC C1608 JB 1H 102K-T-A
C565	4030009650	S.CERAMIC C1608 CH 1H 240J-T-A
C566	4030007010	S.CERAMIC C1608 CH 1H 100D-T-A
C567	4030007070	S.CERAMIC C1608 CH 1H 330J-T-A
C568	4030006980	S.CERAMIC C1608 CH 1H 070D-T-A
C569	4030007060	S.CERAMIC C1608 CH 1H 270J-T-A
C570	4030011600	S.CERAMIC C1608 JB 1C 104KT-N

S.=Surface mount

[RF UNIT]

REF NO.	ORDER NO.	DESCRIPTION	
C601	4030007070	S.CERAMIC	C1608 CH 1H 330J-T-A
C602	4030007040	S.CERAMIC	C1608 CH 1H 180J-T-A
C603	4030007080	S.CERAMIC	C1608 CH 1H 390J-T-A
C604	4030011770	S.CERAMIC	C1608 CH 1H 060B-T-A
C605	4030007050	S.CERAMIC	C1608 CH 1H 220J-T-A
C606	4030011600	S.CERAMIC	C1608 JB 1C 104KT-N
C607	4030011770	S.CERAMIC	C1608 CH 1H 060B-T-A
C608	4030007000	S.CERAMIC	C1608 CH 1H 090D-T-A
C609	4030007070	S.CERAMIC	C1608 CH 1H 330J-T-A
C610	4030007040	S.CERAMIC	C1608 CH 1H 180J-T-A
C611	4030011600	S.CERAMIC	C1608 JB 1C 104KT-N
C613	4030011600	S.CERAMIC	C1608 JB 1C 104KT-N
C614	4030011600	S.CERAMIC	C1608 JB 1C 104KT-N
C616	4030009510	S.CERAMIC	C1608 CH 1H 010B-T-A
C617	4030011600	S.CERAMIC	C1608 JB 1C 104KT-N
C621	4030007070	S.CERAMIC	C1608 CH 1H 330J-T-A
C622	4030009920	S.CERAMIC	C1608 CH 1H 050B-T-A
C623	4030007060	S.CERAMIC	C1608 CH 1H 270J-T-A
C631	4030011600	S.CERAMIC	C1608 JB 1C 104KT-N
C632	4030011340	S.CERAMIC	C1608 CH 1H 471J-T-A
C633	4030006880	S.CERAMIC	C1608 JB 1H 472K-T-A
C634	4030011340	S.CERAMIC	C1608 CH 1H 471J-T-A
C635	4030006880	S.CERAMIC	C1608 JB 1H 472K-T-A
C636	4030006880	S.CERAMIC	C1608 JB 1H 472K-T-A
C637	4030006880	S.CERAMIC	C1608 JB 1H 472K-T-A
C638	4030011600	S.CERAMIC	C1608 JB 1C 104KT-N
C639	4030011600	S.CERAMIC	C1608 JB 1C 104KT-N
C640	4510004630	S.ELECTROLYTIC	ECEV1CA100SR
C651	4030011600	S.CERAMIC	C1608 JB 1C 104KT-N
C652	4030007040	S.CERAMIC	C1608 CH 1H 180J-T-A
C653	4510004630	S.ELECTROLYTIC	ECEV1CA100SR
C655	4540000020	S.TRIMMER	TZVY2Z060A110
C656	4030011600	S.CERAMIC	C1608 JB 1C 104KT-N
C657	4030011600	S.CERAMIC	C1608 JB 1C 104KT-N
C661	4030007080	S.CERAMIC	C1608 CH 1H 390J-T-A
C663	4030011600	S.CERAMIC	C1608 JB 1C 104KT-N
C664	4030006860	S.CERAMIC	C1608 JB 1H 102K-T-A
C665	4030009650	S.CERAMIC	C1608 CH 1H 240J-T-A
C666	4030007010	S.CERAMIC	C1608 CH 1H 100D-T-A
C667	4030007070	S.CERAMIC	C1608 CH 1H 330J-T-A
C668	4030006980	S.CERAMIC	C1608 CH 1H 070D-T-A
C669	4030007060	S.CERAMIC	C1608 CH 1H 270J-T-A
C701	4030006880	S.CERAMIC	C1608 JB 1H 472K-T-A
C702	4030006880	S.CERAMIC	C1608 JB 1H 472K-T-A
C703	4030007030	S.CERAMIC	C1608 CH 1H 150J-T-A
C704	4030006880	S.CERAMIC	C1608 JB 1H 472K-T-A
C705	4030011600	S.CERAMIC	C1608 JB 1C 104KT-N
C706	4030011600	S.CERAMIC	C1608 JB 1C 104KT-N
C711	4030006880	S.CERAMIC	C1608 JB 1H 472K-T-A
C712	4030006880	S.CERAMIC	C1608 JB 1H 472K-T-A
C713	4030006880	S.CERAMIC	C1608 JB 1H 472K-T-A
C714	4030006990	S.CERAMIC	C1608 CH 1H 080D-T-A
C715	4030006990	S.CERAMIC	C1608 CH 1H 080D-T-A
C716	4030006990	S.CERAMIC	C1608 CH 1H 080D-T-A
C721	4030006880	S.CERAMIC	C1608 JB 1H 472K-T-A
C722	4030006860	S.CERAMIC	C1608 JB 1H 102K-T-A
C723	4030007010	S.CERAMIC	C1608 CH 1H 100D-T-A
C724	4030006880	S.CERAMIC	C1608 JB 1H 472K-T-A
C726	4030006880	S.CERAMIC	C1608 JB 1H 472K-T-A
C727	4030007020	S.CERAMIC	C1608 CH 1H 120J-T-A
C728	4030006880	S.CERAMIC	C1608 JB 1H 472K-T-A
C731	4030011600	S.CERAMIC	C1608 JB 1C 104KT-N
C732	4030006880	S.CERAMIC	C1608 JB 1H 472K-T-A
C742	4030011340	S.CERAMIC	C1608 CH 1H 471J-T-A
C743	4030011600	S.CERAMIC	C1608 JB 1C 104KT-N
C744	4030011600	S.CERAMIC	C1608 JB 1C 104KT-N
C745	4030011600	S.CERAMIC	C1608 JB 1C 104KT-N
C746	4030011600	S.CERAMIC	C1608 JB 1C 104KT-N
C751	4030006860	S.CERAMIC	C1608 JB 1H 102K-T-A
C752	4030006880	S.CERAMIC	C1608 JB 1H 472K-T-A
C753	4030006860	S.CERAMIC	C1608 JB 1H 102K-T-A
C754	4030006980	S.CERAMIC	C1608 CH 1H 070D-T-A
C755	4030007020	S.CERAMIC	C1608 CH 1H 120J-T-A
C756	4030006880	S.CERAMIC	C1608 JB 1H 472K-T-A
C757	4030006880	S.CERAMIC	C1608 JB 1H 472K-T-A
C758	4030006880	S.CERAMIC	C1608 JB 1H 472K-T-A
C759	4030006980	S.CERAMIC	C1608 CH 1H 070D-T-A
C760	4030007100	S.CERAMIC	C1608 CH 1H 560J-T-A
C761	4030007100	S.CERAMIC	C1608 CH 1H 560J-T-A
C771	4030006880	S.CERAMIC	C1608 JB 1H 472K-T-A
C772	4030006880	S.CERAMIC	C1608 JB 1H 472K-T-A
C774	4030009920	S.CERAMIC	C1608 CH 1H 050B-T-A

[RF UNIT]

REF NO.	ORDER NO.	DESCRIPTION	
C775	4030007040	S.CERAMIC	C1608 CH 1H 180J-T-A
C781	4030011600	S.CERAMIC	C1608 JB 1C 104KT-N
C783	4030011600	S.CERAMIC	C1608 JB 1C 104KT-N
C784	4030011600	S.CERAMIC	C1608 JB 1C 104KT-N
C785	4030011600	S.CERAMIC	C1608 JB 1C 104KT-N
C786	4030011600	S.CERAMIC	C1608 JB 1C 104KT-N
C787	4030011600	S.CERAMIC	C1608 JB 1C 104KT-N
C788	4030011600	S.CERAMIC	C1608 JB 1C 104KT-N
C789	4030011600	S.CERAMIC	C1608 JB 1C 104KT-N
C791	4030006900	S.CERAMIC	C1608 JB 1E 103K-T-A
C802	4030006880	S.CERAMIC	C1608 JB 1H 472K-T-A
C803	4030006880	S.CERAMIC	C1608 JB 1H 472K-T-A
C805	4030006880	S.CERAMIC	C1608 JB 1H 472K-T-A
C806	4030008920	S.CERAMIC	C1608 JB 1C 473K-T-A
C813	4030007010	S.CERAMIC	C1608 CH 1H 100D-T-A
C814	4030006860	S.CERAMIC	C1608 JB 1H 102K-T-A
C815	4030007030	S.CERAMIC	C1608 CH 1H 150J-T-A
C816	4030006880	S.CERAMIC	C1608 JB 1H 472K-T-A
C818	4030007030	S.CERAMIC	C1608 CH 1H 150J-T-A
C819	4030009520	S.CERAMIC	C1608 CH 1H 020B-T-A
C820	4030006860	S.CERAMIC	C1608 JB 1H 102K-T-A
C823	4030006880	S.CERAMIC	C1608 JB 1H 472K-T-A
C833	4030006980	S.CERAMIC	C1608 CH 1H 070D-T-A
C834	4030006880	S.CERAMIC	C1608 JB 1H 472K-T-A
C835	4030006880	S.CERAMIC	C1608 JB 1H 472K-T-A
C840	4030006980	S.CERAMIC	C1608 CH 1H 070D-T-A
C841	4030007130	S.CERAMIC	C1608 CH 1H 101J-T-A
C844	4030006880	S.CERAMIC	C1608 JB 1H 472K-T-A
C845	4030006860	S.CERAMIC	C1608 JB 1H 102K-T-A
C846	4030006880	S.CERAMIC	C1608 JB 1H 472K-T-A
C847	4030011600	S.CERAMIC	C1608 JB 1C 104KT-N
C848	4030011600	S.CERAMIC	C1608 JB 1C 104KT-N
C862	4510004630	S.ELECTROLYTIC	ECEV1CA100SR
C863	4030006860	S.CERAMIC	C1608 JB 1H 102K-T-A
C872	4030011600	S.CERAMIC	C1608 JB 1C 104KT-N
C873	4030011600	S.CERAMIC	C1608 JB 1C 104KT-N
C874	4030006880	S.CERAMIC	C1608 JB 1H 472K-T-A
C875	4030008920	S.CERAMIC	C1608 JB 1C 473K-T-A
C901	4030011600	S.CERAMIC	C1608 JB 1C 104KT-N
C902	4030011600	S.CERAMIC	C1608 JB 1C 104KT-N
C903	4030011600	S.CERAMIC	C1608 JB 1C 104KT-N
C904	4030011600	S.CERAMIC	C1608 JB 1C 104KT-N
C941	4030011600	S.CERAMIC	C1608 JB 1C 104KT-N
C942	4030011600	S.CERAMIC	C1608 JB 1C 104KT-N
C943	4030011600	S.CERAMIC	C1608 JB 1C 104KT-N
C944	4030011600	S.CERAMIC	C1608 JB 1C 104KT-N
C948	4510004630	S.ELECTROLYTIC	ECEV1CA100SR
C950	4030008920	S.CERAMIC	C1608 JB 1C 473K-T-A
C951	4510004630	S.ELECTROLYTIC	ECEV1CA100SR
C952	4030011600	S.CERAMIC	C1608 JB 1C 104KT-N
C953	4510004630	S.ELECTROLYTIC	ECEV1CA100SR
C954	4030011600	S.CERAMIC	C1608 JB 1C 104KT-N
C955	4510004630	S.ELECTROLYTIC	ECEV1CA100SR
C956	4030011600	S.CERAMIC	C1608 JB 1C 104KT-N
C957	4030011600	S.CERAMIC	C1608 JB 1C 104KT-N
C961	4030007100	S.CERAMIC	C1608 CH 1H 560J-T-A
C962	4030007110	S.CERAMIC	C1608 CH 1H 680J-T-A
C963	4030007130	S.CERAMIC	C1608 CH 1H 101J-T-A
C964	4030007040	S.CERAMIC	C1608 CH 1H 180J-T-A
C965	4030007120	S.CERAMIC	C1608 CH 1H 820J-T-A
C966	4030011600	S.CERAMIC	C1608 JB 1C 104KT-N
C967	4030011600	S.CERAMIC	C1608 JB 1C 104KT-N
C968	4030011600	S.CERAMIC	C1608 JB 1C 104KT-N
C969	4030011600	S.CERAMIC	C1608 JB 1C 104KT-N
C970	4030006880	S.CERAMIC	C1608 JB 1H 472K-T-A
RL101	6330001320	RELAY	AHY103
RL121	6330001320	RELAY	AHY103
RL122	6330001320	RELAY	AHY103
CP871	6910009670	S.CHECK P	HK3-S-T
J101	6510007020	CONNECTOR	TMP-J01X-V6
J111	6450001130	CONNECTOR	JPJ2042-01-110
J151	6510007020	CONNECTOR	TMP-J01X-V6
J481	6510007020	CONNECTOR	TMP-J01X-V6
J561	6510007020	CONNECTOR	TMP-J01X-V6
J661	6510007020	CONNECTOR	TMP-J01X-V6
J741	6510007900	CONNECTOR	TBP-P01X-A1 (B1)

S.=Surface mount

[RF UNIT]

REF NO.	ORDER NO.	DESCRIPTION	
J831	6510007020	CONNECTOR	TMP-J01X-V6
J841	6510007020	CONNECTOR	TMP-J01X-V6
J901	6510007020	CONNECTOR	TMP-J01X-V6
J951	6510019990	S.CONNECTOR	52808-2290
P741	6510003240	CONNECTOR	TMP-P01X-A1
DS111	5080000370	LAMP	HRS-4160A
W392	7030003860	S.JUMPER	ERJ3GE JPW V
W562	7030003860	S.JUMPER	ERJ3GE JPW V
W662	7030003860	S.JUMPER	ERJ3GE JPW V
W941	7030003860	S.JUMPER	ERJ3GE JPW V
EP1	0910051154	PCB	B 5238D

[MAIN UNIT]

REF NO.	ORDER NO.	DESCRIPTION	
IC101	1110000960	S.IC	NJM4558M-T1
IC151	1110004840	S.IC	NJM1496V-TE1
IC201	1110001900	S.IC	μPC4570G2-T1
IC215	1180000990	S.IC	AN78L08M-(E1)
IC221	1110004840	S.IC	NJM1496V-TE1
IC301	1130006220	S.IC	TC4W53FU (TE12L)
IC311	1110003300	S.IC	M5282FP 70CD
IC321	1110000960	S.IC	NJM4558M-T1
IC331	1130006220	S.IC	TC4W53FU (TE12L)
IC332	1110003090	IC	LA4425A
IC361	1130006220	S.IC	TC4W53FU (TE12L)
IC362	1130006220	S.IC	TC4W53FU (TE12L)
IC371	1110003300	S.IC	M5282FP 70CD
IC372	1110003670	S.IC	BA3308F-T1
IC451	1140005280	S.IC	μPC5023GS-077-E1
IC551	1110003870	S.IC	NJM2058M-T1
IC571	1110000960	S.IC	NJM4558M-T1
IC801	1180002000	REG	BA033T
IC802	1180001070	S.IC	TA7805F (TE16L)
IC803	1180001070	S.IC	TA7805F (TE16L)
IC805	1180000720	S.IC	AN79L05M-(E1)
IC3001	1190001000	S.IC	ISD33120S
IC3002	1130008230	S.IC	BU4053BCFV-E2
IC3003	1110003300	S.IC	M5282FP 70CD
IC3004	1110000960	S.IC	NJM4558M-T1
IC3005	1130008230	S.IC	BU4053BCFV-E2
IC3501	1140008590	S.IC	HD64F2357F20
IC3502	1130009110	S.IC	S-80942ANMP-DD6-T2
IC3503	1140005880	S.IC	X25320S8I-2.7T6
IC3504	1130007450	S.IC	RTC-4553A
IC3551	1190000950	S.IC	SED1354F0A (QFP15-128PIN)
IC3552	1130007180	S.IC	TC7WU04FU (TE12L)
IC3553	1130009360	S.IC	LH61665AS-60A
IC3631	1130008230	S.IC	BU4053BCFV-E2
IC3651	1120002770	S.IC	TC74AC244FT (EL)
IC3652	1120002780	S.IC	TC74AC245FT (EL)
IC3653	1120002790	S.IC	TC74AC574FT (EL)
IC3654	1120002790	S.IC	TC74AC574FT (EL)
IC3655	1120002440	S.IC	TC74AC08FS (EL)
IC3656	1120002760	S.IC	TC74AC32FT (EL)
IC3751	1110004310	S.IC	M62352GP 75EC
IC3752	1130007510	S.IC	BU4094BCFV-E1
IC3753	1130007510	S.IC	BU4094BCFV-E1
IC3771	1130007110	S.IC	TC7W04FU (TE12L)
Q141	1590002710	S.TRANSISTOR	UMH11NTN
Q142	1590002310	S.TRANSISTOR	DTC114EE TL
Q241	1560000560	S.FET	2SK882-GR (TE85L)
Q261	1560000560	S.FET	2SK882-GR (TE85L)
Q271	1560000560	S.FET	2SK882-GR (TE85L)
Q272	1560000560	S.FET	2SK882-GR (TE85L)
Q273	1560000560	S.FET	2SK882-GR (TE85L)
Q274	1530002060	S.TRANSISTOR	2SC4081 T107 R
Q275	1510000510	S.TRANSISTOR	2SA1576A T106R

[MAIN UNIT]

REF NO.	ORDER NO.	DESCRIPTION	
Q276	1530002060	S.TRANSISTOR	2SC4081 T107 R
Q277	1590002710	S.TRANSISTOR	UMH11NTN
Q278	1590002530	S.TRANSISTOR	UN911H (TX)
Q331	1540000470	S.TRANSISTOR	2SD1801S-TL
Q333	1590002770	S.FET	CPH3404-TL
Q334	1590002310	S.TRANSISTOR	DTC114EE TL
Q351	1590002310	S.TRANSISTOR	DTC114EE TL
Q471	1530002060	S.TRANSISTOR	2SC4081 T107 R
Q501	1590002710	S.TRANSISTOR	UMH11NTN
Q502	1590002710	S.TRANSISTOR	UMH11NTN
Q503	1530002060	S.TRANSISTOR	2SC4081 T107 R
Q504	1530002060	S.TRANSISTOR	2SC4081 T107 R
Q505	1510000510	S.TRANSISTOR	2SA1576A T106R
Q506	1590002310	S.TRANSISTOR	DTC114EE TL
Q507	1590001870	S.TRANSISTOR	DTA114EE TL
Q521	1510000510	S.TRANSISTOR	2SA1576A T106R
Q601	1540000440	S.TRANSISTOR	2SD1619-T-TD
Q602	1530002060	S.TRANSISTOR	2SC4081 T107 R
Q611	1540000440	S.TRANSISTOR	2SD1619-T-TD
Q612	1530002060	S.TRANSISTOR	2SC4081 T107 R
Q621	1510000920	S.TRANSISTOR	2SA1577 T107 Q
Q622	1590002710	S.TRANSISTOR	UMH11NTN
Q631	1530002060	S.TRANSISTOR	2SC4081 T107 R
Q632	1530002060	S.TRANSISTOR	2SC4081 T107 R
Q651	1590001870	S.TRANSISTOR	DTA114EE TL
Q652	1540000440	S.TRANSISTOR	2SD1619-T-TD
Q653	1590002310	S.TRANSISTOR	DTC114EE TL
Q691	1590002310	S.TRANSISTOR	DTC114EE TL
Q801	1530002060	S.TRANSISTOR	2SC4081 T107 R
Q803	1590002430	S.TRANSISTOR	DTA144EE TL
Q804	1540000470	S.TRANSISTOR	2SD1801S-TL
Q805	1520000510	TRANSISTOR	2SB1133 R
Q3002	1590001870	S.TRANSISTOR	DTA114EE TL
Q3504	1510000500	S.TRANSISTOR	2SA1162-GR (TE85R)
Q3505	1590001940	S.TRANSISTOR	DTC144EE TL
Q3551	1590001870	S.TRANSISTOR	DTA114EE TL
Q3701	1590002310	S.TRANSISTOR	DTC114EE TL
Q3771	1510000510	S.TRANSISTOR	2SA1576A T106R
Q3772	1530002060	S.TRANSISTOR	2SC4081 T107 R
Q3773	1590002310	S.TRANSISTOR	DTC114EE TL
D111	1790001620	S.DIODE	1SV308 (TPL3)
D112	1790001620	S.DIODE	1SV308 (TPL3)
D113	1790000450	S.DIODE	MA862 (TX)
D114	1790000450	S.DIODE	MA862 (TX)
D115	1790001620	S.DIODE	1SV308 (TPL3)
D116	1790001620	S.DIODE	1SV308 (TPL3)
D215	1790001250	S.DIODE	MA2S111-(TX)
D216	1790001250	S.DIODE	MA2S111-(TX)
D251	1750000520	S.DIODE	DAN222TL
D252	1750000520	S.DIODE	DAN222TL
D271	1790001210	S.DIODE	1SS375-TL
D273	1790001250	S.DIODE	MA2S111-(TX)
D351	1750000520	S.DIODE	DAN222TL
D501	1790001040	S.ZENER	MA8033-L (TX)
D502	1790001250	S.DIODE	MA2S111-(TX)
D504	1790001240	S.DIODE	MA2S728-(TX)
D505	1790001040	S.ZENER	MA8033-L (TX)
D531	1790001250	S.DIODE	MA2S111-(TX)
D532	1790001250	S.DIODE	MA2S111-(TX)
D533	1790001250	S.DIODE	MA2S111-(TX)
D541	1790001250	S.DIODE	MA2S111-(TX)
D542	1790001250	S.DIODE	MA2S111-(TX)
D561	1790001250	S.DIODE	MA2S111-(TX)
D571	1790001250	S.DIODE	MA2S111-(TX)
D601	1750000370	S.DIODE	DA221 TL
D611	1750000370	S.DIODE	DA221 TL
D631	1790001250	S.DIODE	MA2S111-(TX)
D632	1790001250	S.DIODE	MA2S111-(TX)
D691	1750000520	S.DIODE	DAN222TL
D801	1790001250	S.DIODE	MA2S111-(TX)
D3001	1750000370	S.DIODE	DA221 TL
D3504	1790001250	S.DIODE	MA2S111-(TX)
D3505	1790001250	S.DIODE	MA2S111-(TX)
D3506	1790001250	S.DIODE	MA2S111-(TX)
D3507	1750000370	S.DIODE	DA221 TL
D3508	1790001560	S.DIODE	1SS372 (TE85R)
D3509	1790001560	S.DIODE	1SS372 (TE85R)
D3601	1790001250	S.DIODE	MA2S111-(TX)
D3602	1790001560	S.DIODE	1SS372 (TE85R)
D3701	1750000520	S.DIODE	DAN222TL

S.=Surface mount

[MAIN UNIT]

REF NO.	ORDER NO.	DESCRIPTION	
D3702	1160000140	S.DIODE	DAP222 TL
D3751	1790001250	S.DIODE	MA2S111-(TX) [USA]
D3752	1790001250	S.DIODE	MA2S111-(TX)
D3753	1790001250	S.DIODE	MA2S111-(TX)
D3754	1790001250	S.DIODE	MA2S111-(TX) [DEN]
D3755	1790001250	S.DIODE	MA2S111-(TX) [DEN]
D3757	1790001250	S.DIODE	MA2S111-(TX)
D3758	1790001250	S.DIODE	MA2S111-(TX)
D3762	1790001250	S.DIODE	MA2S111-(TX) except [FRA]
D3763	1790001250	S.DIODE	MA2S111-(TX) [EUR], [FRA]
D3771	1750000520	S.DIODE	DAN222TL
FI111	2020000260	CERAMIC	CFK455E10
FI131	2020001740	CERAMIC	CFWM455D
FI132	2020001050	S.CERAMIC	SFPC455E-TC01
FI133	2020001510	CERAMIC	CFWS455IT
X3501	6050009520	S.XTAL	CR-520 (19.6608 MHz)
X3551	6060000740	S.CERAMIC	CSTCV26.00MXJ040
L111	6150004080	COIL	LS-468
L112	6150004080	COIL	LS-468
L113	6150004080	COIL	LS-468
L114	6200005490	S.COIL	NL 322522T-331J
L115	6200005490	S.COIL	NL 322522T-331J
L201	6200003950	S.COIL	HF50ACC 322513-T
L202	6200003950	S.COIL	HF50ACC 322513-T
L203	6200003950	S.COIL	HF50ACC 322513-T
L204	6200003950	S.COIL	HF50ACC 322513-T
L205	6200003950	S.COIL	HF50ACC 322513-T
L206	6200003950	S.COIL	HF50ACC 322513-T
L221	6200003260	S.COIL	NL 322522T-101J
L227	6200003260	S.COIL	NL 322522T-101J
L241	6200003520	S.COIL	ELJFB 102K-F
L261	6150004090	COIL	LS-469
L271	6150002291	COIL	LS-450
L272	6150002291	COIL	LS-450
L273	6200005490	S.COIL	NL 322522T-331J
L274	6200003260	S.COIL	NL 322522T-101J
L451	6200001830	S.COIL	NL 322522T-100J
L452	6180002650	COIL	RCR-875D-472K
L641	6200003240	S.COIL	NL 322522T-221J
L642	6200003240	S.COIL	NL 322522T-221J
L643	6200008820	S.COIL	HF70ACC 635050-T
L644	6200008820	S.COIL	HF70ACC 635050-T
L661	6200003260	S.COIL	NL 322522T-101J
L662	6200003260	S.COIL	NL 322522T-101J
L663	6200003950	S.COIL	HF50ACC 322513-T
L664	6200003260	S.COIL	NL 322522T-101J
L665	6200003260	S.COIL	NL 322522T-101J
L666	6200003950	S.COIL	HF50ACC 322513-T
L667	6200003260	S.COIL	NL 322522T-101J
L668	6200003260	S.COIL	NL 322522T-101J
L669	6200003950	S.COIL	HF50ACC 322513-T
L670	6200003260	S.COIL	NL 322522T-101J
L681	6200003260	S.COIL	NL 322522T-101J
L701	2040000490	COIL	EXC-ELDR25C
L702	6200003950	S.COIL	HF50ACC 322513-T
L703	6200003950	S.COIL	HF50ACC 322513-T
L704	6200003260	S.COIL	NL 322522T-101J
L705	6200003260	S.COIL	NL 322522T-101J
L706	6200003260	S.COIL	NL 322522T-101J
L707	6200003260	S.COIL	NL 322522T-101J
L708	6200003260	S.COIL	NL 322522T-101J
L709	6200003950	S.COIL	HF50ACC 322513-T
L710	2040000490	COIL	EXC-ELDR25C
L711	6200003950	S.COIL	HF50ACC 322513-T
L712	6200003950	S.COIL	HF50ACC 322513-T
L713	6200003260	S.COIL	NL 322522T-101J
L714	6200003260	S.COIL	NL 322522T-101J
L715	6200003260	S.COIL	NL 322522T-101J
L716	6200003950	S.COIL	HF50ACC 322513-T
L717	6200003950	S.COIL	HF50ACC 322513-T
L718	2040000490	COIL	EXC-ELDR25C
L719	2040000490	COIL	EXC-ELDR25C
L720	6180003040	COIL	LHL 08NB 101K
L721	6200003220	S.COIL	NL 322522T-151J
L3001	6200001830	S.COIL	NL 322522T-100J
L3002	6200003260	S.COIL	NL 322522T-101J

[MAIN UNIT]

REF NO.	ORDER NO.	DESCRIPTION	
L3501	6200003950	S.COIL	HF50ACC 322513-T
L3601	6200003950	S.COIL	HF50ACC 322513-T
L3602	6200003950	S.COIL	HF50ACC 322513-T
L3603	6180002650	COIL	RCR-875D-472K
L3604	6180002650	COIL	RCR-875D-472K
R102	7030003700	S.RESISTOR	ERJ3GEYJ 154 V (150 kΩ)
R103	7030003680	S.RESISTOR	ERJ3GEYJ 104 V (100 kΩ)
R104	7030003680	S.RESISTOR	ERJ3GEYJ 104 V (100 kΩ)
R105	7030003730	S.RESISTOR	ERJ3GEYJ 274 V (270 kΩ)
R106	7030003680	S.RESISTOR	ERJ3GEYJ 104 V (100 kΩ)
R107	7030003680	S.RESISTOR	ERJ3GEYJ 104 V (100 kΩ)
R108	7030003400	S.RESISTOR	ERJ3GEYJ 471 V (470 Ω)
R111	7030003680	S.RESISTOR	ERJ3GEYJ 104 V (100 kΩ)
R112	7030003400	S.RESISTOR	ERJ3GEYJ 471 V (470 Ω)
R113	7030003440	S.RESISTOR	ERJ3GEYJ 102 V (1 kΩ)
R115	7030000300	S.RESISTOR	MCR10EZHZ 220 Ω (221)
R116	7030003440	S.RESISTOR	ERJ3GEYJ 102 V (1 kΩ)
R118	7030000340	S.RESISTOR	MCR10EZHZ 470 Ω (471)
R119	7030003560	S.RESISTOR	ERJ3GEYJ 103 V (10 kΩ)
R120	7030003560	S.RESISTOR	ERJ3GEYJ 103 V (10 kΩ)
R122	7030003500	S.RESISTOR	ERJ3GEYJ 332 V (3.3 kΩ)
R123	7030003470	S.RESISTOR	ERJ3GEYJ 182 V (1.8 kΩ)
R124	7030003320	S.RESISTOR	ERJ3GEYJ 101 V (100 Ω)
R125	7030003560	S.RESISTOR	ERJ3GEYJ 103 V (10 kΩ)
R126	7030003560	S.RESISTOR	ERJ3GEYJ 103 V (10 kΩ)
R127	7030003560	S.RESISTOR	ERJ3GEYJ 103 V (10 kΩ)
R130	7030003560	S.RESISTOR	ERJ3GEYJ 103 V (10 kΩ)
R132	7030003500	S.RESISTOR	ERJ3GEYJ 332 V (3.3 kΩ)
R133	7030003320	S.RESISTOR	ERJ3GEYJ 101 V (100 Ω)
R134	7030003560	S.RESISTOR	ERJ3GEYJ 103 V (10 kΩ)
R135	7030003440	S.RESISTOR	ERJ3GEYJ 102 V (1 kΩ)
R136	7030003440	S.RESISTOR	ERJ3GEYJ 102 V (1 kΩ)
R151	7030003490	S.RESISTOR	ERJ3GEYJ 272 V (2.7 kΩ)
R152	7030003570	S.RESISTOR	ERJ3GEYJ 123 V (12 kΩ)
R153	7030003570	S.RESISTOR	ERJ3GEYJ 123 V (12 kΩ)
R154	7030003530	S.RESISTOR	ERJ3GEYJ 562 V (5.6 kΩ)
R155	7030003520	S.RESISTOR	ERJ3GEYJ 472 V (4.7 kΩ)
R156	7030003580	S.RESISTOR	ERJ3GEYJ 153 V (15 kΩ)
R157	7030003440	S.RESISTOR	ERJ3GEYJ 102 V (1 kΩ)
R158	7030003440	S.RESISTOR	ERJ3GEYJ 102 V (1 kΩ)
R159	7030003520	S.RESISTOR	ERJ3GEYJ 472 V (4.7 kΩ)
R160	7030003320	S.RESISTOR	ERJ3GEYJ 101 V (100 Ω)
R161	7030003320	S.RESISTOR	ERJ3GEYJ 101 V (100 Ω)
R162	7030003580	S.RESISTOR	ERJ3GEYJ 153 V (15 kΩ)
R163	7030003580	S.RESISTOR	ERJ3GEYJ 153 V (15 kΩ)
R172	7030003680	S.RESISTOR	ERJ3GEYJ 104 V (100 kΩ)
R201	7030003320	S.RESISTOR	ERJ3GEYJ 101 V (100 Ω)
R203	7030003320	S.RESISTOR	ERJ3GEYJ 101 V (100 Ω)
R207	7030005390	S.RESISTOR	RR0816P-102-D (1 kΩ)
R208	7030005390	S.RESISTOR	RR0816P-102-D (1 kΩ)
R209	7030005390	S.RESISTOR	RR0816P-102-D (1 kΩ)
R210	7310002590	S.TRIMMER	RV-109 (222)
R212	7030003320	S.RESISTOR	ERJ3GEYJ 101 V (100 Ω)
R213	7030003320	S.RESISTOR	ERJ3GEYJ 101 V (100 Ω)
R221	7030003440	S.RESISTOR	ERJ3GEYJ 102 V (1 kΩ)
R222	7030003420	S.RESISTOR	ERJ3GEYJ 681 V (680 Ω)
R223	7030003510	S.RESISTOR	ERJ3GEYJ 392 V (3.9 kΩ)
R224	7030003360	S.RESISTOR	ERJ3GEYJ 221 V (220 Ω)
R225	7030003530	S.RESISTOR	ERJ3GEYJ 562 V (5.6 kΩ)
R226	7030003440	S.RESISTOR	ERJ3GEYJ 102 V (1 kΩ)
R227	7030003440	S.RESISTOR	ERJ3GEYJ 102 V (1 kΩ)
R229	7030003530	S.RESISTOR	ERJ3GEYJ 562 V (5.6 kΩ)
R230	7030003520	S.RESISTOR	ERJ3GEYJ 472 V (4.7 kΩ)
R231	7030003500	S.RESISTOR	ERJ3GEYJ 332 V (3.3 kΩ)
R232	7030003500	S.RESISTOR	ERJ3GEYJ 332 V (3.3 kΩ)
R241	7030009690	S.RESISTOR	RR0816P-101-D (100 Ω)
R242	7030003400	S.RESISTOR	ERJ3GEYJ 471 V (470 Ω)
R244	7030005680	S.RESISTOR	RR0816R-473-D (47 kΩ)
R246	7030005980	S.RESISTOR	RR0816P-333-D (33 Ω)
R247	7310002760	S.TRIMMER	RV-152 (223)
R248	7030003320	S.RESISTOR	ERJ3GEYJ 101 V (100 Ω)
R249	7030003680	S.RESISTOR	ERJ3GEYJ 104 V (100 kΩ)
R250	7030003440	S.RESISTOR	ERJ3GEYJ 102 V (1 kΩ)
R251	7030003440	S.RESISTOR	ERJ3GEYJ 102 V (1 kΩ)
R252	7030003470	S.RESISTOR	ERJ3GEYJ 182 V (1.8 kΩ)
R253	7030003470	S.RESISTOR	ERJ3GEYJ 182 V (1.8 kΩ)
R261	7030003490	S.RESISTOR	ERJ3GEYJ 272 V (2.7 kΩ)
R262	7030003440	S.RESISTOR	ERJ3GEYJ 102 V (1 kΩ)
R263	7310002760	S.TRIMMER	RV-152 (223)
R264	7030003320	S.RESISTOR	ERJ3GEYJ 101 V (100 Ω)

S.=Surface mount

[MAIN UNIT]

REF NO.	ORDER NO.	DESCRIPTION
R271	7310002590	S.TRIMMER RV-109 (222)
R272	7030003400	S.RESISTOR ERJ3GEYJ 471 V (470 Ω)
R273	7030003320	S.RESISTOR ERJ3GEYJ 101 V (100 Ω)
R274	7030003600	S.RESISTOR ERJ3GEYJ 223 V (22 kΩ)
R275	7030003400	S.RESISTOR ERJ3GEYJ 471 V (470 Ω)
R276	7030003320	S.RESISTOR ERJ3GEYJ 101 V (100 Ω)
R277	7030003600	S.RESISTOR ERJ3GEYJ 223 V (22 kΩ)
R278	7030003400	S.RESISTOR ERJ3GEYJ 471 V (470 Ω)
R279	7030003500	S.RESISTOR ERJ3GEYJ 332 V (3.3 kΩ)
R280	7030003320	S.RESISTOR ERJ3GEYJ 101 V (100 Ω)
R281	7030003680	S.RESISTOR ERJ3GEYJ 104 V (100 kΩ)
R283	7030003640	S.RESISTOR ERJ3GEYJ 473 V (47 kΩ)
R284	7030003640	S.RESISTOR ERJ3GEYJ 473 V (47 kΩ)
R285	7030003840	S.RESISTOR ERJ3GEYJ 225 V (2.2 MΩ)
R286	7030003380	S.RESISTOR ERJ3GEYJ 331 V (330 Ω)
R287	7030003540	S.RESISTOR ERJ3GEYJ 682 V (6.8 kΩ)
R288	7030003440	S.RESISTOR ERJ3GEYJ 102 V (1 kΩ)
R289	7030003400	S.RESISTOR ERJ3GEYJ 471 V (470 Ω)
R290	7030003600	S.RESISTOR ERJ3GEYJ 223 V (22 kΩ)
R291	7030003280	S.RESISTOR ERJ3GEYJ 470 V (47 Ω)
R301	7030003440	S.RESISTOR ERJ3GEYJ 102 V (1 kΩ)
R302	7030003440	S.RESISTOR ERJ3GEYJ 102 V (1 kΩ)
R303	7030003440	S.RESISTOR ERJ3GEYJ 102 V (1 kΩ)
R304	7030003560	S.RESISTOR ERJ3GEYJ 103 V (10 kΩ)
R305	7030003400	S.RESISTOR ERJ3GEYJ 471 V (470 Ω)
R306	7030003400	S.RESISTOR ERJ3GEYJ 471 V (470 Ω)
R307	7030003560	S.RESISTOR ERJ3GEYJ 103 V (10 kΩ)
R309	7030003440	S.RESISTOR ERJ3GEYJ 102 V (1 kΩ)
R311	7030003640	S.RESISTOR ERJ3GEYJ 473 V (47 kΩ)
R312	7030003560	S.RESISTOR ERJ3GEYJ 103 V (10 kΩ)
R313	7030003440	S.RESISTOR ERJ3GEYJ 102 V (1 kΩ)
R314	7030003520	S.RESISTOR ERJ3GEYJ 472 V (4.7 kΩ)
R315	7030003640	S.RESISTOR ERJ3GEYJ 473 V (47 kΩ)
R316	7030003200	S.RESISTOR ERJ3GEYJ 100 V (10 Ω)
R317	7030003550	S.RESISTOR ERJ3GEYJ 822 V (8.2 kΩ)
R318	7030003610	S.RESISTOR ERJ3GEYJ 273 V (27 kΩ)
R319	7030003480	S.RESISTOR ERJ3GEYJ 222 V (2.2 kΩ)
R320	7030003680	S.RESISTOR ERJ3GEYJ 104 V (100 kΩ)
R321	7030003520	S.RESISTOR ERJ3GEYJ 472 V (4.7 kΩ)
R322	7030003690	S.RESISTOR ERJ3GEYJ 124 V (120 kΩ)
R323	7030003690	S.RESISTOR ERJ3GEYJ 124 V (120 kΩ)
R324	7030003690	S.RESISTOR ERJ3GEYJ 124 V (120 kΩ)
R325	7030003440	S.RESISTOR ERJ3GEYJ 102 V (1 kΩ)
R331	7030003400	S.RESISTOR ERJ3GEYJ 471 V (470 Ω)
R332	7030003400	S.RESISTOR ERJ3GEYJ 471 V (470 Ω)
R333	7030003520	S.RESISTOR ERJ3GEYJ 472 V (4.7 kΩ)
R334	7030003440	S.RESISTOR ERJ3GEYJ 102 V (1 kΩ)
R335	7030003400	S.RESISTOR ERJ3GEYJ 471 V (470 Ω)
R336	7030003280	S.RESISTOR ERJ3GEYJ 470 V (47 Ω)
R337	7030003560	S.RESISTOR ERJ3GEYJ 103 V (10 kΩ)
R338	7030003680	S.RESISTOR ERJ3GEYJ 104 V (100 kΩ)
R339	7030003680	S.RESISTOR ERJ3GEYJ 104 V (100 kΩ)
R340	7030003440	S.RESISTOR ERJ3GEYJ 102 V (1 kΩ)
R341	7030003680	S.RESISTOR ERJ3GEYJ 104 V (100 kΩ)
R342	7030003720	S.RESISTOR ERJ3GEYJ 224 V (220 kΩ)
R343	7030003560	S.RESISTOR ERJ3GEYJ 103 V (10 kΩ)
R351	7030003200	S.RESISTOR ERJ3GEYJ 100 V (10 Ω)
R361	7030003400	S.RESISTOR ERJ3GEYJ 471 V (470 Ω)
R362	7030003400	S.RESISTOR ERJ3GEYJ 471 V (470 Ω)
R363	7030003560	S.RESISTOR ERJ3GEYJ 103 V (10 kΩ)
R364	7030003630	S.RESISTOR ERJ3GEYJ 393 V (39 kΩ)
R365	7030003640	S.RESISTOR ERJ3GEYJ 473 V (47 kΩ)
R366	7030003520	S.RESISTOR ERJ3GEYJ 472 V (4.7 kΩ)
R367	7030003480	S.RESISTOR ERJ3GEYJ 222 V (2.2 kΩ)
R369	7030003440	S.RESISTOR ERJ3GEYJ 102 V (1 kΩ)
R370	7030003320	S.RESISTOR ERJ3GEYJ 101 V (100 Ω)
R371	7030003760	S.RESISTOR ERJ3GEYJ 474 V (470 kΩ)
R372	7030003640	S.RESISTOR ERJ3GEYJ 473 V (47 kΩ)
R373	7030003480	S.RESISTOR ERJ3GEYJ 222 V (2.2 kΩ)
R374	7030003680	S.RESISTOR ERJ3GEYJ 104 V (100 kΩ)
R375	7030003520	S.RESISTOR ERJ3GEYJ 472 V (4.7 kΩ)
R376	7030003800	S.RESISTOR ERJ3GEYJ 105 V (1 MΩ)
R377	7030003520	S.RESISTOR ERJ3GEYJ 472 V (4.7 kΩ)
R378	7030003320	S.RESISTOR ERJ3GEYJ 101 V (100 Ω)
R379	7030003550	S.RESISTOR ERJ3GEYJ 822 V (8.2 kΩ)
R380	7030003610	S.RESISTOR ERJ3GEYJ 273 V (27 kΩ)
R381	7030003480	S.RESISTOR ERJ3GEYJ 222 V (2.2 kΩ)
R390	7030003400	S.RESISTOR ERJ3GEYJ 471 V (470 Ω)
R391	7030003400	S.RESISTOR ERJ3GEYJ 471 V (470 Ω)
R392	7310002580	S.TRIMMER RV-108 (104)
R393	7030003640	S.RESISTOR ERJ3GEYJ 473 V (47 kΩ)
R394	7030003680	S.RESISTOR ERJ3GEYJ 104 V (100 kΩ)

[MAIN UNIT]

REF NO.	ORDER NO.	DESCRIPTION
R395	7030003680	S.RESISTOR ERJ3GEYJ 104 V (100 kΩ)
R453	7030003520	S.RESISTOR ERJ3GEYJ 472 V (4.7 kΩ)
R454	7030003880	S.RESISTOR ERJ3GEYJ 244 V (240 kΩ)
R455	7030003700	S.RESISTOR ERJ3GEYJ 154 V (150 kΩ)
R456	7030003550	S.RESISTOR ERJ3GEYJ 822 V (8.2 kΩ)
R457	7030003510	S.RESISTOR ERJ3GEYJ 392 V (3.9 kΩ)
R458	7030003540	S.RESISTOR ERJ3GEYJ 682 V (6.8 kΩ)
R459	7030003720	S.RESISTOR ERJ3GEYJ 224 V (220 kΩ)
R460	7030003680	S.RESISTOR ERJ3GEYJ 104 V (100 kΩ)
R461	7030003600	S.RESISTOR ERJ3GEYJ 223 V (22 kΩ)
R462	7030003560	S.RESISTOR ERJ3GEYJ 103 V (10 kΩ)
R463	7030003560	S.RESISTOR ERJ3GEYJ 103 V (10 kΩ)
R464	7030003640	S.RESISTOR ERJ3GEYJ 473 V (47 kΩ)
R465	7030003520	S.RESISTOR ERJ3GEYJ 472 V (4.7 kΩ)
R466	7030003560	S.RESISTOR ERJ3GEYJ 103 V (10 kΩ)
R471	7030003560	S.RESISTOR ERJ3GEYJ 103 V (10 kΩ)
R472	7030003520	S.RESISTOR ERJ3GEYJ 472 V (4.7 kΩ)
R473	7030003580	S.RESISTOR ERJ3GEYJ 153 V (15 kΩ)
R474	7030003390	S.RESISTOR ERJ3GEYJ 391 V (390 Ω)
R475	7030003680	S.RESISTOR ERJ3GEYJ 104 V (100 kΩ)
R476	7030003320	S.RESISTOR ERJ3GEYJ 101 V (100 Ω)
R477	7030003550	S.RESISTOR ERJ3GEYJ 822 V (8.2 kΩ)
R478	7030003680	S.RESISTOR ERJ3GEYJ 104 V (100 kΩ)
R479	7030003540	S.RESISTOR ERJ3GEYJ 682 V (6.8 kΩ)
R480	7030003580	S.RESISTOR ERJ3GEYJ 153 V (15 kΩ)
R501	7030008180	S.RESISTOR ERJ12YJ331H (330 Ω)
R503	7030003600	S.RESISTOR ERJ3GEYJ 223 V (22 kΩ)
R504	7030003620	S.RESISTOR ERJ3GEYJ 333 V (33 kΩ)
R505	7030003720	S.RESISTOR ERJ3GEYJ 224 V (220 kΩ)
R507	7310002800	S.TRIMMER RV-156 (224)
R509	7310002800	S.TRIMMER RV-156 (224)
R510	7310002800	S.TRIMMER RV-156 (224)
R511	7030003680	S.RESISTOR ERJ3GEYJ 104 V (100 kΩ)
R512	7030003820	S.RESISTOR ERJ3GEYJ 155 V (1.5 MΩ)
R513	7030003380	S.RESISTOR ERJ3GEYJ 331 V (330 Ω)
R514	7030003640	S.RESISTOR ERJ3GEYJ 473 V (47 kΩ)
R515	7030003760	S.RESISTOR ERJ3GEYJ 474 V (470 kΩ)
R516	7030003600	S.RESISTOR ERJ3GEYJ 223 V (22 kΩ)
R517	7030003760	S.RESISTOR ERJ3GEYJ 474 V (470 kΩ)
R521	7030003560	S.RESISTOR ERJ3GEYJ 103 V (10 kΩ)
R522	7030003680	S.RESISTOR ERJ3GEYJ 104 V (100 kΩ)
R531	7030003680	S.RESISTOR ERJ3GEYJ 104 V (100 kΩ)
R532	7030003560	S.RESISTOR ERJ3GEYJ 103 V (10 kΩ)
R533	7030003720	S.RESISTOR ERJ3GEYJ 224 V (220 kΩ)
R534	7030003660	S.RESISTOR ERJ3GEYJ 683 V (68 kΩ)
R535	7030003500	S.RESISTOR ERJ3GEYJ 332 V (3.3 kΩ)
R536	7030003400	S.RESISTOR ERJ3GEYJ 471 V (470 Ω)
R537	7510000770	S.THERMISTOR NTCCS2012 3SH 223KC-T
R541	7030003640	S.RESISTOR ERJ3GEYJ 473 V (47 kΩ)
R542	7030003640	S.RESISTOR ERJ3GEYJ 473 V (47 kΩ)
R543	7030003620	S.RESISTOR ERJ3GEYJ 333 V (33 kΩ)
R544	7030003620	S.RESISTOR ERJ3GEYJ 333 V (33 kΩ)
R545	7310002740	S.TRIMMER RV-150 (103)
R546	7030003800	S.RESISTOR ERJ3GEYJ 105 V (1 MΩ)
R551	7030009920	S.RESISTOR ERJ3GEYJ 335 V (3.3 MΩ)
R552	7030009930	S.RESISTOR ERJ3GEYJ 825 V (8.2 MΩ)
R553	7030003840	S.RESISTOR ERJ3GEYJ 225 V (2.2 MΩ)
R564	7030003560	S.RESISTOR ERJ3GEYJ 103 V (10 kΩ)
R574	7030003560	S.RESISTOR ERJ3GEYJ 103 V (10 kΩ)
R601	7030006210	S.RESISTOR ERJ12YJ4R7H (4.7 Ω)
R602	7030003440	S.RESISTOR ERJ3GEYJ 102 V (1 kΩ)
R603	7030003560	S.RESISTOR ERJ3GEYJ 103 V (10 kΩ)
R611	7030006210	S.RESISTOR ERJ12YJ4R7H (4.7 Ω)
R612	7030003440	S.RESISTOR ERJ3GEYJ 102 V (1 kΩ)
R613	7030003560	S.RESISTOR ERJ3GEYJ 103 V (10 kΩ)
R621	7030003640	S.RESISTOR ERJ3GEYJ 473 V (47 kΩ)
R622	7030003460	S.RESISTOR ERJ3GEYJ 152 V (1.5 kΩ)
R623	7030003560	S.RESISTOR ERJ3GEYJ 103 V (10 kΩ)
R631	7030003520	S.RESISTOR ERJ3GEYJ 472 V (4.7 kΩ)
R632	7030003620	S.RESISTOR ERJ3GEYJ 333 V (33 kΩ)
R633	7030003580	S.RESISTOR ERJ3GEYJ 153 V (15 kΩ)
R634	7030003520	S.RESISTOR ERJ3GEYJ 472 V (4.7 kΩ)
R635	7030003520	S.RESISTOR ERJ3GEYJ 472 V (4.7 kΩ)
R636	7030003620	S.RESISTOR ERJ3GEYJ 333 V (33 kΩ)
R637	7030003580	S.RESISTOR ERJ3GEYJ 153 V (15 kΩ)
R638	7030003520	S.RESISTOR ERJ3GEYJ 472 V (4.7 kΩ)
R651	7030003380	S.RESISTOR ERJ3GEYJ 331 V (330 Ω)
R652	7030003560	S.RESISTOR ERJ3GEYJ 103 V (10 kΩ)
R653	7030003550	S.RESISTOR ERJ3GEYJ 822 V (8.2 kΩ)
R691	7030003200	S.RESISTOR ERJ3GEYJ 100 V (10 Ω)
R761	7030003360	S.RESISTOR ERJ3GEYJ 221 V (220 Ω)
R762	7030003360	S.RESISTOR ERJ3GEYJ 221 V (220 Ω)

S.=Surface mount

[MAIN UNIT]

REF NO.	ORDER NO.	DESCRIPTION	
R3702	7030003640	S.RESISTOR	ERJ3GEYJ 473 V (47 kΩ)
R3703	7030003640	S.RESISTOR	ERJ3GEYJ 473 V (47 kΩ)
R3704	7030003640	S.RESISTOR	ERJ3GEYJ 473 V (47 kΩ)
R3705	7030003640	S.RESISTOR	ERJ3GEYJ 473 V (47 kΩ)
R3706	7030003440	S.RESISTOR	ERJ3GEYJ 102 V (1 kΩ)
R3707	7030003440	S.RESISTOR	ERJ3GEYJ 102 V (1 kΩ)
R3709	7030003440	S.RESISTOR	ERJ3GEYJ 102 V (1 kΩ)
R3710	7030003440	S.RESISTOR	ERJ3GEYJ 102 V (1 kΩ)
R3711	7030003440	S.RESISTOR	ERJ3GEYJ 102 V (1 kΩ)
R3712	7030003440	S.RESISTOR	ERJ3GEYJ 102 V (1 kΩ)
R3721	7030003640	S.RESISTOR	ERJ3GEYJ 473 V (47 kΩ)
R3722	7030003640	S.RESISTOR	ERJ3GEYJ 473 V (47 kΩ)
R3723	7030003580	S.RESISTOR	ERJ3GEYJ 153 V (15 kΩ)
R3724	7030003440	S.RESISTOR	ERJ3GEYJ 102 V (1 kΩ)
R3725	7030003640	S.RESISTOR	ERJ3GEYJ 473 V (47 kΩ)
R3726	7030003440	S.RESISTOR	ERJ3GEYJ 102 V (1 kΩ)
R3727	7030003440	S.RESISTOR	ERJ3GEYJ 102 V (1 kΩ)
R3728	7030003640	S.RESISTOR	ERJ3GEYJ 473 V (47 kΩ)
R3732	7030003640	S.RESISTOR	ERJ3GEYJ 473 V (47 kΩ)
R3740	7030009890	S.RESISTOR	RR0816P-151-D (150 Ω)
R3741	7030009850	S.RESISTOR	RR0816P-271-D (270 Ω)
R3751	7030003440	S.RESISTOR	ERJ3GEYJ 102 V (1 kΩ)
R3752	7030003440	S.RESISTOR	ERJ3GEYJ 102 V (1 kΩ)
R3753	7030003440	S.RESISTOR	ERJ3GEYJ 102 V (1 kΩ)
R3754	7030003440	S.RESISTOR	ERJ3GEYJ 102 V (1 kΩ)
R3755	7030003440	S.RESISTOR	ERJ3GEYJ 102 V (1 kΩ)
R3756	7030003440	S.RESISTOR	ERJ3GEYJ 102 V (1 kΩ)
R3757	7030003440	S.RESISTOR	ERJ3GEYJ 102 V (1 kΩ)
R3758	7030003440	S.RESISTOR	ERJ3GEYJ 102 V (1 kΩ)
R3759	7030003640	S.RESISTOR	ERJ3GEYJ 473 V (47 kΩ)
R3761	7030003320	S.RESISTOR	ERJ3GEYJ 101 V (100 Ω)
R3762	7030003440	S.RESISTOR	ERJ3GEYJ 102 V (1 kΩ)
R3763	7030003440	S.RESISTOR	ERJ3GEYJ 102 V (1 kΩ)
R3764	7030003320	S.RESISTOR	ERJ3GEYJ 101 V (100 Ω)
R3765	7030003440	S.RESISTOR	ERJ3GEYJ 102 V (1 kΩ)
R3766	7030003440	S.RESISTOR	ERJ3GEYJ 102 V (1 kΩ)
R3767	7030003440	S.RESISTOR	ERJ3GEYJ 102 V (1 kΩ)
R3768	7030003440	S.RESISTOR	ERJ3GEYJ 102 V (1 kΩ)
R3769	7030003640	S.RESISTOR	ERJ3GEYJ 473 V (47 kΩ)
R3770	7030003640	S.RESISTOR	ERJ3GEYJ 473 V (47 kΩ)
R3771	7030003640	S.RESISTOR	ERJ3GEYJ 473 V (47 kΩ)
R3772	7030003640	S.RESISTOR	ERJ3GEYJ 473 V (47 kΩ)
R3773	7030003640	S.RESISTOR	ERJ3GEYJ 473 V (47 kΩ)
R3774	7030003640	S.RESISTOR	ERJ3GEYJ 473 V (47 kΩ)
R3775	7030003540	S.RESISTOR	ERJ3GEYJ 682 V (6.8 kΩ)
R3776	7030003620	S.RESISTOR	ERJ3GEYJ 333 V (33 kΩ)
R3777	7030003580	S.RESISTOR	ERJ3GEYJ 153 V (15 kΩ)
R3778	7030003640	S.RESISTOR	ERJ3GEYJ 473 V (47 kΩ)
R3779	7030003680	S.RESISTOR	ERJ3GEYJ 104 V (100 kΩ)
R3780	7030003440	S.RESISTOR	ERJ3GEYJ 102 V (1 kΩ)
R3781	7030003640	S.RESISTOR	ERJ3GEYJ 473 V (47 kΩ)
R3782	7030003640	S.RESISTOR	ERJ3GEYJ 473 V (47 kΩ)
R3783	7030003640	S.RESISTOR	ERJ3GEYJ 473 V (47 kΩ)
R3784	7030003680	S.RESISTOR	ERJ3GEYJ 104 V (100 kΩ)
R3785	7030003640	S.RESISTOR	ERJ3GEYJ 473 V (47 kΩ)
R3786	7030003680	S.RESISTOR	ERJ3GEYJ 104 V (100 kΩ)
R3787	7030003560	S.RESISTOR	ERJ3GEYJ 103 V (10 kΩ)
R3801	7030003360	S.RESISTOR	ERJ3GEYJ 221 V (220 Ω)
R3802	7030003360	S.RESISTOR	ERJ3GEYJ 221 V (220 Ω)
R3803	7030003360	S.RESISTOR	ERJ3GEYJ 221 V (220 Ω)
C102	4030006880	S.CERAMIC	C1608 JB 1H 472K-T-A
C103	4030011600	S.CERAMIC	C1608 JB 1C 104KT-N
C104	4030011600	S.CERAMIC	C1608 JB 1C 104KT-N
C115	4030011600	S.CERAMIC	C1608 JB 1C 104KT-N
C116	4030011600	S.CERAMIC	C1608 JB 1C 104KT-N
C121	4030011600	S.CERAMIC	C1608 JB 1C 104KT-N
C122	4030011600	S.CERAMIC	C1608 JB 1C 104KT-N
C123	4030011600	S.CERAMIC	C1608 JB 1C 104KT-N
C125	4030011600	S.CERAMIC	C1608 JB 1C 104KT-N
C126	4030011600	S.CERAMIC	C1608 JB 1C 104KT-N
C127	4030006880	S.CERAMIC	C1608 JB 1H 472K-T-A
C129	4030006880	S.CERAMIC	C1608 JB 1H 472K-T-A
C130	4030011600	S.CERAMIC	C1608 JB 1C 104KT-N
C131	4030011600	S.CERAMIC	C1608 JB 1C 104KT-N
C132	4030006880	S.CERAMIC	C1608 JB 1H 472K-T-A
C133	4030006880	S.CERAMIC	C1608 JB 1H 472K-T-A
C135	4030011600	S.CERAMIC	C1608 JB 1C 104KT-N
C146	4030006880	S.CERAMIC	C1608 JB 1H 472K-T-A
C151	4510004430	S.ELECTROLYTIC	ECEV1CV220WR
C152	4030011600	S.CERAMIC	C1608 JB 1C 104KT-N

[MAIN UNIT]

REF NO.	ORDER NO.	DESCRIPTION	
C153	4030011600	S.CERAMIC	C1608 JB 1C 104KT-N
C154	4510004630	S.ELECTROLYTIC	ECEV1CA100SR
C155	4030006880	S.CERAMIC	C1608 JB 1H 102K-T-A
C156	4030011600	S.CERAMIC	C1608 JB 1C 104KT-N
C157	4510004430	S.ELECTROLYTIC	ECEV1CV220WR
C171	4030011600	S.CERAMIC	C1608 JB 1C 104KT-N
C201	4510004630	S.ELECTROLYTIC	ECEV1CA100SR
C202	4510004630	S.ELECTROLYTIC	ECEV1CA100SR
C203	4030006870	S.CERAMIC	C1608 JB 1H 222K-T-A
C204	4030006870	S.CERAMIC	C1608 JB 1H 222K-T-A
C205	4030006900	S.CERAMIC	C1608 JB 1E 103K-T-A
C206	4030010020	S.CERAMIC	C1608 JB 1H 122K-T-A
C207	4030010040	S.CERAMIC	C1608 JB 1H 561K-T-A
C208	4030007120	S.CERAMIC	C1608 CH 1H 820J-T-A
C209	4510006670	S.ELECTROLYTIC	ECEV1CA471P
C210	4030011600	S.CERAMIC	C1608 JB 1C 104KT-N
C211	4030006880	S.CERAMIC	C1608 JB 1H 472K-T-A
C215	4510004630	S.ELECTROLYTIC	ECEV1CA100SR
C216	4510004630	S.ELECTROLYTIC	ECEV1CA100SR
C217	4030011600	S.CERAMIC	C1608 JB 1C 104KT-N
C221	4030006860	S.CERAMIC	C1608 JB 1H 102K-T-A
C222	4510004630	S.ELECTROLYTIC	ECEV1CA100SR
C223	4030011600	S.CERAMIC	C1608 JB 1C 104KT-N
C224	4550006080	S.TANTALUM	TEMSVB2 1C 106M-8L
C225	4030011600	S.CERAMIC	C1608 JB 1C 104KT-N
C226	4030011600	S.CERAMIC	C1608 JB 1C 104KT-N
C227	4510004630	S.ELECTROLYTIC	ECEV1CA100SR
C228	4030011600	S.CERAMIC	C1608 JB 1C 104KT-N
C229	4030007130	S.CERAMIC	C1608 CH 1H 101J-T-A
C231	4030011600	S.CERAMIC	C1608 JB 1C 104KT-N
C241	4030011600	S.CERAMIC	C1608 JB 1C 104KT-N
C242	4030006880	S.CERAMIC	C1608 JB 1H 472K-T-A
C243	4030006880	S.CERAMIC	C1608 JB 1H 472K-T-A
C244	4030006880	S.CERAMIC	C1608 JB 1H 472K-T-A
C245	4030011600	S.CERAMIC	C1608 JB 1C 104KT-N
C246	4030011600	S.CERAMIC	C1608 JB 1C 104KT-N
C247	4030011600	S.CERAMIC	C1608 JB 1C 104KT-N
C261	4030006880	S.CERAMIC	C1608 JB 1H 472K-T-A
C262	4030008920	S.CERAMIC	C1608 JB 1C 473K-T-A
C264	4030011600	S.CERAMIC	C1608 JB 1C 104KT-N
C266	4030006860	S.CERAMIC	C1608 JB 1H 102K-T-A
C267	4510004630	S.ELECTROLYTIC	ECEV1CA100SR
C271	4030011600	S.CERAMIC	C1608 JB 1C 104KT-N
C272	4030011600	S.CERAMIC	C1608 JB 1C 104KT-N
C274	4030011600	S.CERAMIC	C1608 JB 1C 104KT-N
C275	4030011600	S.CERAMIC	C1608 JB 1C 104KT-N
C277	4030011600	S.CERAMIC	C1608 JB 1C 104KT-N
C278	4030010760	S.CERAMIC	C1608 CH 1H 331J-T-A
C279	4030011600	S.CERAMIC	C1608 JB 1C 104KT-N
C280	4030006870	S.CERAMIC	C1608 JB 1H 222K-T-A
C281	4030006850	S.CERAMIC	C1608 JB 1H 471K-T-A
C282	4030012600	S.CERAMIC	C2012 JB 1A 105M-T-A
C283	4030011600	S.CERAMIC	C1608 JB 1C 104KT-N
C284	4510004640	S.ELECTROLYTIC	ECEV1CA470SP
C285	4030011600	S.CERAMIC	C1608 JB 1C 104KT-N
C286	4510004630	S.ELECTROLYTIC	ECEV1CA100SR
C287	4510006220	S.ELECTROLYTIC	ECEV1CA101UP
C301	4510004630	S.ELECTROLYTIC	ECEV1CA100SR
C302	4510004630	S.ELECTROLYTIC	ECEV1CA100SR
C303	4510004630	S.ELECTROLYTIC	ECEV1CA100SR
C304	4030011600	S.CERAMIC	C1608 JB 1C 104KT-N
C305	4030011600	S.CERAMIC	C1608 JB 1C 104KT-N
C306	4030011600	S.CERAMIC	C1608 JB 1C 104KT-N
C307	4030011600	S.CERAMIC	C1608 JB 1C 104KT-N
C308	4510005890	S.ELECTROLYTIC	ECEV1AAN100R
C311	4510005860	S.ELECTROLYTIC	ECEV1HA2R2SR
C312	4030006870	S.CERAMIC	C1608 JB 1H 222K-T-A
C313	4510004630	S.ELECTROLYTIC	ECEV1CA100SR
C314	4510004630	S.ELECTROLYTIC	ECEV1CA100SR
C315	4510004630	S.ELECTROLYTIC	ECEV1CA100SR
C316	4510004990	ELECTROLYTIC	16 MV 100 HC
C317	4030012600	S.CERAMIC	C2012 JB 1A 105M-T-A
C318	4510004630	S.ELECTROLYTIC	ECEV1CA100SR
C319	4030012600	S.CERAMIC	C2012 JB 1A 105M-T-A
C320	4030012600	S.CERAMIC	C2012 JB 1A 105M-T-A
C321	4030006880	S.CERAMIC	C1608 JB 1H 472K-T-A
C322	4030006880	S.CERAMIC	C1608 JB 1H 472K-T-A
C323	4030006860	S.CERAMIC	C1608 JB 1H 102K-T-A
C324	4030006860	S.CERAMIC	C1608 JB 1H 102K-T-A
C325	4030011600	S.CERAMIC	C1608 JB 1C 104KT-N
C326	4030011600	S.CERAMIC	C1608 JB 1C 104KT-N
C327	4030012600	S.CERAMIC	C2012 JB 1A 105M-T-A

S.=Surface mount

[MAIN UNIT]

REF NO.	ORDER NO.	DESCRIPTION
C331	4510004630	S.ELECTROLYTIC ECEV1CA100SR
C332	4510004630	S.ELECTROLYTIC ECEV1CA100SR
C333	4030008950	S.CERAMIC C2012 JB 1C 823K-T-A
C334	4510004630	S.ELECTROLYTIC ECEV1CA100SR
C335	4030008880	S.CERAMIC C1608 JB 1C 223K-T-A
C336	4030011600	S.CERAMIC C1608 JB 1C 104KT-N
C337	4510006670	S.ELECTROLYTIC ECEV1CA471P
C338	4510006670	S.ELECTROLYTIC ECEV1CA471P
C340	4510006220	S.ELECTROLYTIC ECEV1CA101UP
C341	4030011600	S.CERAMIC C1608 JB 1C 104KT-N
C351	4030006880	S.CERAMIC C1608 JB 1H 472K-T-A
C352	4030006880	S.CERAMIC C1608 JB 1H 472K-T-A
C353	4030006880	S.CERAMIC C1608 JB 1H 472K-T-A
C361	4030011600	S.CERAMIC C1608 JB 1C 104KT-N
C362	4030011600	S.CERAMIC C1608 JB 1C 104KT-N
C363	4510001350	ELECTROLYTIC 16 MS5 10UF
C364	4510004630	S.ELECTROLYTIC ECEV1CA100SR
C365	4550002980	S.TANTALUM TEMSVA 1C 225M-8L
C371	4030012600	S.CERAMIC C2012 JB 1A 105M-T-A
C372	4550000460	S.TANTALUM TESVA 1C 105M1-8L
C374	4510004630	S.ELECTROLYTIC ECEV1CA100SR
C375	4510004630	S.ELECTROLYTIC ECEV1CA100SR
C376	4030006900	S.CERAMIC C1608 JB 1E 103K-T-A
C377	4510004630	S.ELECTROLYTIC ECEV1CA100SR
C378	4030012600	S.CERAMIC C2012 JB 1A 105M-T-A
C379	4510004630	S.ELECTROLYTIC ECEV1CA100SR
C390	4030011600	S.CERAMIC C1608 JB 1C 104KT-N
C391	4030011600	S.CERAMIC C1608 JB 1C 104KT-N
C392	4030011600	S.CERAMIC C1608 JB 1C 104KT-N
C453	4510001160	ELECTROLYTIC 50 MS7 1UF
C456	4030007130	S.CERAMIC C1608 CH 1H 101J-T-A
C457	4510005860	S.ELECTROLYTIC ECEV1HA2R2SR
C458	4030008880	S.CERAMIC C1608 JB 1C 223K-T-A
C459	4030006860	S.CERAMIC C1608 JB 1H 102K-T-A
C460	4030008880	S.CERAMIC C1608 JB 1C 223K-T-A
C461	4030012600	S.CERAMIC C2012 JB 1A 105M-T-A
C462	4030007130	S.CERAMIC C1608 CH 1H 101J-T-A
C463	4030011600	S.CERAMIC C1608 JB 1C 104KT-N
C464	4510004630	S.ELECTROLYTIC ECEV1CA100SR
C465	4030011600	S.CERAMIC C1608 JB 1C 104KT-N
C466	4510004630	S.ELECTROLYTIC ECEV1CA100SR
C467	4030006860	S.CERAMIC C1608 JB 1H 102K-T-A
C471	4030012600	S.CERAMIC C2012 JB 1A 105M-T-A
C472	4510005860	S.ELECTROLYTIC ECEV1HA2R2SR
C473	4510004630	S.ELECTROLYTIC ECEV1CA100SR
C474	4510006220	S.ELECTROLYTIC ECEV1CA101UP
C475	4030012600	S.CERAMIC C2012 JB 1A 105M-T-A
C476	4030011600	S.CERAMIC C1608 JB 1C 104KT-N
C477	4510006670	S.ELECTROLYTIC ECEV1CA471P
C502	4030012600	S.CERAMIC C2012 JB 1A 105M-T-A
C504	4030012600	S.CERAMIC C2012 JB 1A 105M-T-A
C506	4030012610	S.CERAMIC C2012 JB 1C 474K-T-A
C507	4030011600	S.CERAMIC C1608 JB 1C 104KT-N
C508	4550006080	S.TANTALUM TEMSVB2 1C 106M-8L
C552	4030011600	S.CERAMIC C1608 JB 1C 104KT-N
C553	4030011600	S.CERAMIC C1608 JB 1C 104KT-N
C561	4510004630	S.ELECTROLYTIC ECEV1CA100SR
C571	4510004630	S.ELECTROLYTIC ECEV1CA100SR
C572	4030011600	S.CERAMIC C1608 JB 1C 104KT-N
C573	4030011600	S.CERAMIC C1608 JB 1C 104KT-N
C601	4510005810	S.ELECTROLYTIC ECEV1HAR47R
C611	4510005810	S.ELECTROLYTIC ECEV1HAR47R
C631	4030006880	S.CERAMIC C1608 JB 1H 472K-T-A
C632	4030006880	S.CERAMIC C1608 JB 1H 472K-T-A
C641	4030006880	S.CERAMIC C1608 JB 1H 472K-T-A
C642	4030006880	S.CERAMIC C1608 JB 1H 472K-T-A
C643	4030006880	S.CERAMIC C1608 JB 1H 472K-T-A
C651	4030006880	S.CERAMIC C1608 JB 1H 472K-T-A
C661	4030006880	S.CERAMIC C1608 JB 1H 472K-T-A
C662	4030006880	S.CERAMIC C1608 JB 1H 472K-T-A
C663	4030006880	S.CERAMIC C1608 JB 1H 472K-T-A
C664	4030006880	S.CERAMIC C1608 JB 1H 472K-T-A
C665	4030006880	S.CERAMIC C1608 JB 1H 472K-T-A
C666	4030006880	S.CERAMIC C1608 JB 1H 472K-T-A
C667	4030006880	S.CERAMIC C1608 JB 1H 472K-T-A
C668	4030006880	S.CERAMIC C1608 JB 1H 472K-T-A
C669	4030006880	S.CERAMIC C1608 JB 1H 472K-T-A
C670	4030006880	S.CERAMIC C1608 JB 1H 472K-T-A
C681	4030006880	S.CERAMIC C1608 JB 1H 472K-T-A
C691	4030006880	S.CERAMIC C1608 JB 1H 472K-T-A
C692	4030006880	S.CERAMIC C1608 JB 1H 472K-T-A
C701	4030007130	S.CERAMIC C1608 CH 1H 101J-T-A

[MAIN UNIT]

REF NO.	ORDER NO.	DESCRIPTION
C702	4030011600	S.CERAMIC C1608 JB 1C 104KT-N
C703	4030011600	S.CERAMIC C1608 JB 1C 104KT-N
C704	4030011600	S.CERAMIC C1608 JB 1C 104KT-N
C705	4030011600	S.CERAMIC C1608 JB 1C 104KT-N
C706	4030011600	S.CERAMIC C1608 JB 1C 104KT-N
C707	4030011600	S.CERAMIC C1608 JB 1C 104KT-N
C708	4030011600	S.CERAMIC C1608 JB 1C 104KT-N
C709	4030011600	S.CERAMIC C1608 JB 1C 104KT-N
C710	4030011600	S.CERAMIC C1608 JB 1C 104KT-N
C711	4030011600	S.CERAMIC C1608 JB 1C 104KT-N
C712	4030011600	S.CERAMIC C1608 JB 1C 104KT-N
C713	4030011600	S.CERAMIC C1608 JB 1C 104KT-N
C714	4030011600	S.CERAMIC C1608 JB 1C 104KT-N
C715	4030011600	S.CERAMIC C1608 JB 1C 104KT-N
C716	4030011600	S.CERAMIC C1608 JB 1C 104KT-N
C801	4030011600	S.CERAMIC C1608 JB 1C 104KT-N
C802	4510004630	S.ELECTROLYTIC ECEV1CA100SR
C803	4030011600	S.CERAMIC C1608 JB 1C 104KT-N
C804	4510006220	S.ELECTROLYTIC ECEV1CA101UP
C805	4030011600	S.CERAMIC C1608 JB 1C 104KT-N
C806	4510004630	S.ELECTROLYTIC ECEV1CA100SR
C807	4030011600	S.CERAMIC C1608 JB 1C 104KT-N
C808	4510006220	S.ELECTROLYTIC ECEV1CA101UP
C813	4510006220	S.ELECTROLYTIC ECEV1CA101UP
C814	4030011600	S.CERAMIC C1608 JB 1C 104KT-N
C815	4510004630	S.ELECTROLYTIC ECEV1CA100SR
C816	4030011600	S.CERAMIC C1608 JB 1C 104KT-N
C817	4510006220	S.ELECTROLYTIC ECEV1CA101UP
C818	4550006250	S.TANTALUM TEMSVA 1A 106M-8L
C819	4550006050	S.TANTALUM TEMSVA 0J 106M8L
C826	4030011600	S.CERAMIC C1608 JB 1C 104KT-N
C827	4030011600	S.CERAMIC C1608 JB 1C 104KT-N
C828	4030011600	S.CERAMIC C1608 JB 1C 104KT-N
C829	4030011600	S.CERAMIC C1608 JB 1C 104KT-N
C831	4030011600	S.CERAMIC C1608 JB 1C 104KT-N
C832	4030011600	S.CERAMIC C1608 JB 1C 104KT-N
C833	4030006880	S.CERAMIC C1608 JB 1H 472K-T-A
C834	4030011600	S.CERAMIC C1608 JB 1C 104KT-N
C835	4510006220	S.ELECTROLYTIC ECEV1CA101UP
C836	4550006770	S.TANTALUM TEMSVD2 1C 476M-12R
C837	4030006880	S.CERAMIC C1608 JB 1H 472K-T-A
C853	4030011600	S.CERAMIC C1608 JB 1C 104KT-N
C856	4030011600	S.CERAMIC C1608 JB 1C 104KT-N
C857	4030011600	S.CERAMIC C1608 JB 1C 104KT-N
C859	4030011600	S.CERAMIC C1608 JB 1C 104KT-N
C861	4030011600	S.CERAMIC C1608 JB 1C 104KT-N
C863	4030011600	S.CERAMIC C1608 JB 1C 104KT-N
C864	4030011600	S.CERAMIC C1608 JB 1C 104KT-N
C865	4030006880	S.CERAMIC C1608 JB 1H 472K-T-A
C866	4030006880	S.CERAMIC C1608 JB 1H 472K-T-A
C867	4510006220	S.ELECTROLYTIC ECEV1CA101UP
C868	4030011600	S.CERAMIC C1608 JB 1C 104KT-N
C869	4510006850	S.ELECTROLYTIC ECEV1CA4R7NR (16V 4.7)
C3001	4030012600	S.CERAMIC C2012 JB 1A 105M-T-A
C3003	4030011600	S.CERAMIC C1608 JB 1C 104KT-N
C3004	4030012600	S.CERAMIC C2012 JB 1A 105M-T-A
C3005	4030011600	S.CERAMIC C1608 JB 1C 104KT-N
C3006	4030011600	S.CERAMIC C1608 JB 1C 104KT-N
C3008	4510006850	S.ELECTROLYTIC ECEV1CA4R7NR (16V 4.7)
C3009	4510004430	S.ELECTROLYTIC ECEV1CV220WR
C3010	4510006670	S.ELECTROLYTIC ECEV1CA471P
C3011	4510006670	S.ELECTROLYTIC ECEV1CA471P
C3012	4030008920	S.CERAMIC C1608 JB 1C 473K-T-A
C3013	4030011600	S.CERAMIC C1608 JB 1C 104KT-N
C3014	4510004630	S.ELECTROLYTIC ECEV1CA100SR
C3015	4510004630	S.ELECTROLYTIC ECEV1CA100SR
C3016	4510004630	S.ELECTROLYTIC ECEV1CA100SR
C3017	4510004630	S.ELECTROLYTIC ECEV1CA100SR
C3018	4510004630	S.ELECTROLYTIC ECEV1CA100SR
C3019	4510004630	S.ELECTROLYTIC ECEV1CA100SR
C3020	4510004630	S.ELECTROLYTIC ECEV1CA100SR
C3021	4030011600	S.CERAMIC C1608 JB 1C 104KT-N
C3025	4510004630	S.ELECTROLYTIC ECEV1CA100SR
C3030	4030011600	S.CERAMIC C1608 JB 1C 104KT-N
C3031	4030011600	S.CERAMIC C1608 JB 1C 104KT-N
C3032	4030011600	S.CERAMIC C1608 JB 1C 104KT-N
C3501	4030007020	S.CERAMIC C1608 CH 1H 120J-T-A
C3502	4030007020	S.CERAMIC C1608 CH 1H 120J-T-A
C3503	4030006900	S.CERAMIC C1608 JB 1E 103K-T-A
C3504	4030006900	S.CERAMIC C1608 JB 1E 103K-T-A
C3505	4030006900	S.CERAMIC C1608 JB 1E 103K-T-A
C3506	4030006880	S.CERAMIC C1608 JB 1H 472K-T-A

S.=Surface mount

[MAIN UNIT]

REF NO.	ORDER NO.	DESCRIPTION
C3507	4030006900	S.CERAMIC C1608 JB 1E 103K-T-A
C3508	4030011600	S.CERAMIC C1608 JB 1C 104KT-N
C3509	4030006900	S.CERAMIC C1608 JB 1E 103K-T-A
C3510	4510004630	S.ELECTROLYTIC ECEV1CA100SR
C3511	4030006900	S.CERAMIC C1608 JB 1E 103K-T-A
C3512	4030006900	S.CERAMIC C1608 JB 1E 103K-T-A
C3513	4510005940	ELECTROL 10 MV 470 HC
C3552	4030006900	S.CERAMIC C1608 JB 1E 103K-T-A
C3553	4030006900	S.CERAMIC C1608 JB 1E 103K-T-A
C3554	4030006900	S.CERAMIC C1608 JB 1E 103K-T-A
C3555	4030006900	S.CERAMIC C1608 JB 1E 103K-T-A
C3556	4030006900	S.CERAMIC C1608 JB 1E 103K-T-A
C3557	4030006900	S.CERAMIC C1608 JB 1E 103K-T-A
C3558	4510006220	S.ELECTROLYTIC ECEV1CA101UP
C3560	4030006900	S.CERAMIC C1608 JB 1E 103K-T-A
C3561	4030006880	S.CERAMIC C1608 JB 1H 472K-T-A
C3562	4510006220	S.ELECTROLYTIC ECEV1CA101UP
C3601	4030011600	S.CERAMIC C1608 JB 1C 104KT-N
C3602	4510006220	S.ELECTROLYTIC ECEV1CA101UP
C3603	4030011600	S.CERAMIC C1608 JB 1C 104KT-N
C3604	4510006670	S.ELECTROLYTIC ECEV1CA471P
C3605	4030011600	S.CERAMIC C1608 JB 1C 104KT-N
C3606	4030007170	S.CERAMIC C1608 CH 1H 221J-T-A
C3607	4030006860	S.CERAMIC C1608 JB 1H 102K-T-A
C3608	4030006900	S.CERAMIC C1608 JB 1E 103K-T-A
C3609	4030006900	S.CERAMIC C1608 JB 1E 103K-T-A
C3610	4030006900	S.CERAMIC C1608 JB 1E 103K-T-A
C3611	4030006880	S.CERAMIC C1608 JB 1H 472K-T-A
C3612	4030006880	S.CERAMIC C1608 JB 1H 472K-T-A
C3614	4030006880	S.CERAMIC C1608 JB 1H 472K-T-A
C3615	4030006880	S.CERAMIC C1608 JB 1H 472K-T-A
C3624	4030006880	S.CERAMIC C1608 JB 1H 472K-T-A
C3625	4030006880	S.CERAMIC C1608 JB 1H 472K-T-A
C3626	4030006880	S.CERAMIC C1608 JB 1H 472K-T-A
C3631	4030006880	S.CERAMIC C1608 JB 1H 472K-T-A
C3632	4030006880	S.CERAMIC C1608 JB 1H 472K-T-A
C3633	4030006880	S.CERAMIC C1608 JB 1H 472K-T-A
C3634	4030006880	S.CERAMIC C1608 JB 1H 472K-T-A
C3635	4030006880	S.CERAMIC C1608 JB 1H 472K-T-A
C3636	4030006880	S.CERAMIC C1608 JB 1H 472K-T-A
C3637	4030006880	S.CERAMIC C1608 JB 1H 472K-T-A
C3638	4030011600	S.CERAMIC C1608 JB 1C 104KT-N
C3641	4030006880	S.CERAMIC C1608 JB 1H 472K-T-A
C3642	4030006880	S.CERAMIC C1608 JB 1H 472K-T-A
C3643	4030006880	S.CERAMIC C1608 JB 1H 472K-T-A
C3651	4030006900	S.CERAMIC C1608 JB 1E 103K-T-A
C3652	4030006900	S.CERAMIC C1608 JB 1E 103K-T-A
C3653	4030006900	S.CERAMIC C1608 JB 1E 103K-T-A
C3654	4030006900	S.CERAMIC C1608 JB 1E 103K-T-A
C3655	4030006930	S.CERAMIC C1608 CH 1H 020C-T-A
C3656	4030006900	S.CERAMIC C1608 JB 1E 103K-T-A
C3657	4030006900	S.CERAMIC C1608 JB 1E 103K-T-A
C3702	4030006880	S.CERAMIC C1608 JB 1H 472K-T-A
C3704	4030006880	S.CERAMIC C1608 JB 1H 472K-T-A
C3706	4030006880	S.CERAMIC C1608 JB 1H 472K-T-A
C3707	4030006880	S.CERAMIC C1608 JB 1H 472K-T-A
C3708	4030006880	S.CERAMIC C1608 JB 1H 472K-T-A
C3709	4030006880	S.CERAMIC C1608 JB 1H 472K-T-A
C3711	4030006900	S.CERAMIC C1608 JB 1E 103K-T-A
C3712	4030006900	S.CERAMIC C1608 JB 1E 103K-T-A
C3721	4030006880	S.CERAMIC C1608 JB 1H 472K-T-A
C3722	4030006880	S.CERAMIC C1608 JB 1H 472K-T-A
C3723	4030006880	S.CERAMIC C1608 JB 1H 472K-T-A
C3724	4030006880	S.CERAMIC C1608 JB 1H 472K-T-A
C3725	4030011600	S.CERAMIC C1608 JB 1C 104KT-N
C3751	4030006880	S.CERAMIC C1608 JB 1H 472K-T-A
C3752	4030006880	S.CERAMIC C1608 JB 1H 472K-T-A
C3753	4030006880	S.CERAMIC C1608 JB 1H 472K-T-A
C3754	4030006880	S.CERAMIC C1608 JB 1H 472K-T-A
C3755	4030006880	S.CERAMIC C1608 JB 1H 472K-T-A
C3756	4030006880	S.CERAMIC C1608 JB 1H 472K-T-A
C3757	4030006880	S.CERAMIC C1608 JB 1H 472K-T-A
C3758	4030006880	S.CERAMIC C1608 JB 1H 472K-T-A
C3761	4030006880	S.CERAMIC C1608 JB 1H 472K-T-A
C3762	4030006880	S.CERAMIC C1608 JB 1H 472K-T-A
C3763	4030006880	S.CERAMIC C1608 JB 1H 472K-T-A
C3764	4030006880	S.CERAMIC C1608 JB 1H 472K-T-A
C3765	4030006880	S.CERAMIC C1608 JB 1H 472K-T-A
C3766	4030006880	S.CERAMIC C1608 JB 1H 472K-T-A
C3767	4030006880	S.CERAMIC C1608 JB 1H 472K-T-A
C3768	4030006880	S.CERAMIC C1608 JB 1H 472K-T-A
C3769	4030006880	S.CERAMIC C1608 JB 1H 472K-T-A

[MAIN UNIT]

REF NO.	ORDER NO.	DESCRIPTION
C3770	4030006880	S.CERAMIC C1608 JB 1H 472K-T-A
C3771	4030011600	S.CERAMIC C1608 JB 1C 104KT-N
C3772	4030011600	S.CERAMIC C1608 JB 1C 104KT-N
C3773	4030011600	S.CERAMIC C1608 JB 1C 104KT-N
C3774	4030011600	S.CERAMIC C1608 JB 1C 104KT-N
C3775	4510006670	S.ELECTROLYTIC ECEV1CA471P
C3801	4030007090	S.CERAMIC C1608 CH 1H 470J-T-A
C3802	4030007090	S.CERAMIC C1608 CH 1H 470J-T-A
C3803	4030007090	S.CERAMIC C1608 CH 1H 470J-T-A
RL351	6330001320	RELAY AHY103
RL691	6330000540	RELAY OMR-109F
CP271	6910009670	S.CHECK P HK3-S-T
CP501	6910009670	S.CHECK P HK3-S-T
J101	6510007020	CONNECTOR TMP-J01X-V6
J201	6910012460	CONNECTOR IMSA-9180S-30A
J202	6910012460	CONNECTOR IMSA-9180S-30A
J203	6510018960	S.CONNECTOR B2B-PH-SM3-TB
J211	6510007020	CONNECTOR TMP-J01X-V6
J351	6450000140	CONNECTOR HSJ0807-01-010
J352	6510009870	CONNECTOR PD054-02M
J641	6510018970	S.CONNECTOR B4B-PH-SM3-TB
J661	6450000170	CONNECTOR TCS4480-01-1111
J662	6450000160	CONNECTOR TCS4470-01-1111
J681	6450001490	CONNECTOR HLJ7001-01-3010
J691	6450001130	CONNECTOR JJP2042-01-110
J701	6450000140	CONNECTOR HSJ0807-01-010
J741	6510019990	S.CONNECTOR 52808-2290
J771	6510020000	S.CONNECTOR 52808-3090
J811	6510019990	S.CONNECTOR 52808-2290
J841	6510019980	S.CONNECTOR 52808-1690
J861	6510021560	S.CONNECTOR 52808-2490
J891	6510021560	S.CONNECTOR 52808-2490
J1702	6510019970	S.CONNECTOR 52808-1090
J3501	6510021860	CONNECTOR BH-800.8
J3502	6510019190	S.CONNECTOR 52365-0891
J3503	6510022060	S.CONNECTOR AXK5S30235P
J3504	6510022060	S.CONNECTOR AXK5S30235P
P352	6510003640	CONNECTOR EHR04
BT3501	3020000110	LITHIUM CR2032
W201	7030003860	S.JUMPER ERJ3GE JPW V
W308	7030003860	S.JUMPER ERJ3GE JPW V
W311	7030003860	S.JUMPER ERJ3GE JPW V
W354	7030003860	S.JUMPER ERJ3GE JPW V
W355	7030003860	S.JUMPER ERJ3GE JPW V
W451	7030003860	S.JUMPER ERJ3GE JPW V
W452	7030008240	S.JUMPER ERJ12YJ0R00H
W501	7030003860	S.JUMPER ERJ3GE JPW V
W503	7030003860	S.JUMPER ERJ3GE JPW V
W561	7030003860	S.JUMPER ERJ3GE JPW V
W562	7030003860	S.JUMPER ERJ3GE JPW V
W571	7030003860	S.JUMPER ERJ3GE JPW V
W572	7030003860	S.JUMPER ERJ3GE JPW V
W701	7030003860	S.JUMPER ERJ3GE JPW V
W1001	7030009300	S.JUMPER ERJ1WY0R00H
W3001	7030003860	S.JUMPER ERJ3GE JPW V
W3010	7030003860	S.JUMPER ERJ3GE JPW V
W3014	7030003860	S.JUMPER ERJ3GE JPW V
W3504	7030003860	S.JUMPER ERJ3GE JPW V
W3551	7030003860	S.JUMPER ERJ3GE JPW V
W3601	7030003860	S.JUMPER ERJ3GE JPW V
EP1	0910051105	PCB B 5239E

S.=Surface mount

[DSP BOARD]

REF NO.	ORDER NO.		DESCRIPTION
IC2001	1190000970	S.IC	ADSP-21061LKS-160
IC2041	1130008360	S.IC	TC7SHU04FU (TE85L)
IC2042	1130008040	S.IC	TC7SH04FU
IC2051	1130009310	S.IC	TC74VHC125FT (EL)
IC2052	1130009300	S.IC	TC7SET08FU (TE85L)
IC2053	1130006080	S.IC	TC74HC02AF (TP1)
IC2054	1130009620	S.IC	TC74VHC74FT (EL)
IC2061	1130009300	S.IC	TC7SET08FU (TE85L)
IC2062	1130009290	S.IC	TC74VHC541FT (EL)
IC2063	1130009300	S.IC	TC7SET08FU (TE85L)
IC2065	1130009300	S.IC	TC7SET08FU (TE85L)
IC2066	1130009300	S.IC	TC7SET08FU (TE85L)
IC2071	1130009350	IC	NM27C512Q120/SC1371
IC2072	1130009290	S.IC	TC74VHC541FT (EL)
IC2091	1110004920	S.IC	S-80934ANMP-DDY
IC2092	1130006540	S.IC	TC7S02FU (TE85R)
IC2101	1130008810	S.IC	TC7SH32FU (TE85L)
IC2201	1130008230	S.IC	BU4053BCFV-E2
IC2211	1110003750	S.IC	M5218AFP 600C
IC2281	1110003870	S.IC	NJM2058M-T1
IC2291	1130006220	S.IC	TC4W53FU (TE12L)
IC2301	1110001900	S.IC	µPC4570G2-T1
IC2302	1130006220	S.IC	TC4W53FU (TE12L)
IC2321	1190000960	S.IC	CS5396-KS
IC2341	1130009610	S.IC	TC74VHC00FT (EL)
IC2342	1130009630	S.IC	TC74VHC4040FT (EL)
IC2343	1130009280	S.IC	TC7WH74FU (TE12L)
IC2344	1130009620	S.IC	TC74VHC74FT (EL)
IC2345	1130008810	S.IC	TC7SH32FU (TE85L)
IC2346	1130009300	S.IC	TC7SET08FU (TE85L)
IC2347	1130007131	S.IC	TC74HC390AF (EL)
IC2348	1130009300	S.IC	TC7SET08FU (TE85L)
IC2351	1190001170	S.IC	AD1855JRSRL
IC2352	1130008360	S.IC	TC7SHU04FU (TE85L)
IC2353	1130008040	S.IC	TC7SH04FU
IC2371	1110001900	S.IC	µPC4570G2-T1
IC2372	1130008230	S.IC	BU4053BCFV-E2
IC2381	1110005060	S.IC	µPC4574G2-E1
IC2401	1190001100	S.IC	MAX293CWE-W
IC2441	1110003870	S.IC	NJM2058M-T1
IC2461	1110004770	S.IC	BU9480F-E2
IC2471	1110003750	S.IC	M5218AFP 600C
IC2472	1110003750	S.IC	M5218AFP 600C
IC2473	1130006220	S.IC	TC4W53FU (TE12L)
IC2474	1130008040	S.IC	TC7SH04FU
IC2475	1130009300	S.IC	TC7SET08FU (TE85L)
Q2201	1590002310	S.TRANSISTOR	DTC114EE TL
Q2202	1590002310	S.TRANSISTOR	DTC114EE TL
Q2211	1590002310	S.TRANSISTOR	DTC114EE TL
Q2213	1590002310	S.TRANSISTOR	DTC114EE TL
Q2321	1590002470	S.FET	2SJ381-TD
Q2322	1590002470	S.FET	2SJ381-TD
D2371	1730002320	S.ZENER	MA8051-M (TX)
D2372	1730002320	S.ZENER	MA8051-M (TX)
X2041	6050009880	S.XTAL	CR-568 (40.000 MHz)
X2351	6050010650	S.XTAL	CR-643 (24.576 MHz)
L2001	6190001190	S.COIL	D10F-A814AY-101K=P3
L2401	6200003260	S.COIL	NL 322522T-101J
L2402	6200003260	S.COIL	NL 322522T-101J
L2461	6200003260	S.COIL	NL 322522T-101J
L2502	6200003950	S.COIL	HF50ACC 322513-T
L2503	6200003950	S.COIL	HF50ACC 322513-T
L2504	6200003950	S.COIL	HF50ACC 322513-T
L2506	6200003950	S.COIL	HF50ACC 322513-T
R2001	7030003560	S.RESISTOR	ERJ3GEYJ 103 V (10 kΩ)
R2002	7030003560	S.RESISTOR	ERJ3GEYJ 103 V (10 kΩ)
R2003	7030003560	S.RESISTOR	ERJ3GEYJ 103 V (10 kΩ)
R2004	7030003560	S.RESISTOR	ERJ3GEYJ 103 V (10 kΩ)
R2005	7030003560	S.RESISTOR	ERJ3GEYJ 103 V (10 kΩ)
R2006	7030003560	S.RESISTOR	ERJ3GEYJ 103 V (10 kΩ)
R2007	7030003560	S.RESISTOR	ERJ3GEYJ 103 V (10 kΩ)
R2008	7030003560	S.RESISTOR	ERJ3GEYJ 103 V (10 kΩ)

[DSP BOARD]

REF NO.	ORDER NO.		DESCRIPTION
R2009	7030003560	S.RESISTOR	ERJ3GEYJ 103 V (10 kΩ)
R2010	7030003560	S.RESISTOR	ERJ3GEYJ 103 V (10 kΩ)
R2011	7030003560	S.RESISTOR	ERJ3GEYJ 103 V (10 kΩ)
R2012	7030003560	S.RESISTOR	ERJ3GEYJ 103 V (10 kΩ)
R2013	7030003560	S.RESISTOR	ERJ3GEYJ 103 V (10 kΩ)
R2014	7030003560	S.RESISTOR	ERJ3GEYJ 103 V (10 kΩ)
R2015	7030003560	S.RESISTOR	ERJ3GEYJ 103 V (10 kΩ)
R2016	7030003560	S.RESISTOR	ERJ3GEYJ 103 V (10 kΩ)
R2017	7030003560	S.RESISTOR	ERJ3GEYJ 103 V (10 kΩ)
R2018	7030003560	S.RESISTOR	ERJ3GEYJ 103 V (10 kΩ)
R2019	7030003560	S.RESISTOR	ERJ3GEYJ 103 V (10 kΩ)
R2020	7030003560	S.RESISTOR	ERJ3GEYJ 103 V (10 kΩ)
R2041	7030003800	S.RESISTOR	ERJ3GEYJ 105 V (1 MΩ)
R2042	7030003320	S.RESISTOR	ERJ3GEYJ 101 V (100 Ω)
R2043	7030003320	S.RESISTOR	ERJ3GEYJ 101 V (100 Ω)
R2051	7030003320	S.RESISTOR	ERJ3GEYJ 101 V (100 Ω)
R2052	7030003320	S.RESISTOR	ERJ3GEYJ 101 V (100 Ω)
R2053	7030003320	S.RESISTOR	ERJ3GEYJ 101 V (100 Ω)
R2054	7030003320	S.RESISTOR	ERJ3GEYJ 101 V (100 Ω)
R2062	7030003640	S.RESISTOR	ERJ3GEYJ 473 V (47 kΩ)
R2063	7030003320	S.RESISTOR	ERJ3GEYJ 101 V (100 Ω)
R2064	7030003320	S.RESISTOR	ERJ3GEYJ 101 V (100 Ω)
R2065	7030003320	S.RESISTOR	ERJ3GEYJ 101 V (100 Ω)
R2066	7030003320	S.RESISTOR	ERJ3GEYJ 101 V (100 Ω)
R2067	7030003640	S.RESISTOR	ERJ3GEYJ 473 V (47 kΩ)
R2068	7030003640	S.RESISTOR	ERJ3GEYJ 473 V (47 kΩ)
R2071	7030003320	S.RESISTOR	ERJ3GEYJ 101 V (100 Ω)
R2072	7030003560	S.RESISTOR	ERJ3GEYJ 103 V (10 kΩ)
R2073	7030003560	S.RESISTOR	ERJ3GEYJ 103 V (10 kΩ)
R2074	7030003320	S.RESISTOR	ERJ3GEYJ 101 V (100 Ω)
R2083	7030003320	S.RESISTOR	ERJ3GEYJ 101 V (100 Ω)
R2091	7030003560	S.RESISTOR	ERJ3GEYJ 103 V (10 kΩ)
R2092	7030003320	S.RESISTOR	ERJ3GEYJ 101 V (100 Ω)
R2101	7030003680	S.RESISTOR	ERJ3GEYJ 104 V (100 kΩ)
R2102	7030003320	S.RESISTOR	ERJ3GEYJ 101 V (100 Ω)
R2201	7030003680	S.RESISTOR	ERJ3GEYJ 104 V (100 kΩ)
R2202	7030003320	S.RESISTOR	ERJ3GEYJ 101 V (100 Ω)
R2203	7030003320	S.RESISTOR	ERJ3GEYJ 101 V (100 Ω)
R2211	7030003680	S.RESISTOR	ERJ3GEYJ 104 V (100 kΩ)
R2212	7030003640	S.RESISTOR	ERJ3GEYJ 473 V (47 kΩ)
R2213	7030005510	S.RESISTOR	RR0816P-303-D (30 kΩ)
R2214	7030006100	S.RESISTOR	RR0816P-183-D (18 kΩ)
R2215	7030003370	S.RESISTOR	ERJ3GEYJ 271 V (270 Ω)
R2216	7030003460	S.RESISTOR	ERJ3GEYJ 152 V (1.5 kΩ)
R2217	7030003750	S.RESISTOR	ERJ3GEYJ 394 V (390 kΩ)
R2218	7030003320	S.RESISTOR	ERJ3GEYJ 101 V (100 Ω)
R2219	7030003750	S.RESISTOR	ERJ3GEYJ 394 V (390 kΩ)
R2220	7030003760	S.RESISTOR	ERJ3GEYJ 474 V (470 kΩ)
R2221	7030003700	S.RESISTOR	ERJ3GEYJ 154 V (150 kΩ)
R2222	7030003670	S.RESISTOR	ERJ3GEYJ 823 V (82 kΩ)
R2223	7030003670	S.RESISTOR	ERJ3GEYJ 823 V (82 kΩ)
R2224	7030003760	S.RESISTOR	ERJ3GEYJ 474 V (470 kΩ)
R2226	7030003440	S.RESISTOR	ERJ3GEYJ 102 V (1 kΩ)
R2227	7310002720	S.TRIMMER	RV-148 (472)
R2228	7030003440	S.RESISTOR	ERJ3GEYJ 102 V (1 kΩ)
R2229	7310002720	S.TRIMMER	RV-148 (472)
R2230	7030005980	S.RESISTOR	RR0816P-333-D (33 Ω)
R2241	7030005320	S.RESISTOR	RR0816P-103-D (10 kΩ)
R2242	7030003880	S.RESISTOR	ERJ3GEYJ 244 V (240 kΩ)
R2243	7030005320	S.RESISTOR	RR0816P-103-D (10 kΩ)
R2244	7030005330	S.RESISTOR	RR0816P-562-D (5.6 kΩ)
R2245	7030005390	S.RESISTOR	RR0816P-102-D (1 kΩ)
R2252	7030006560	S.RESISTOR	RR0816P-223-D (22 kΩ)
R2253	7030006560	S.RESISTOR	RR0816P-223-D (22 kΩ)
R2254	7030006560	S.RESISTOR	RR0816P-223-D (22 kΩ)
R2255	7030006560	S.RESISTOR	RR0816P-223-D (22 kΩ)
R2256	7030006560	S.RESISTOR	RR0816P-223-D (22 kΩ)
R2257	7030003440	S.RESISTOR	ERJ3GEYJ 102 V (1 kΩ)
R2281	7030003320	S.RESISTOR	ERJ3GEYJ 101 V (100 Ω)
R2282	7030003320	S.RESISTOR	ERJ3GEYJ 101 V (100 Ω)
R2291	7030003320	S.RESISTOR	ERJ3GEYJ 101 V (100 Ω)
R2292	7030003320	S.RESISTOR	ERJ3GEYJ 101 V (100 Ω)
R2293	7030003680	S.RESISTOR	ERJ3GEYJ 104 V (100 kΩ)
R2302	7030003440	S.RESISTOR	ERJ3GEYJ 102 V (1 kΩ)
R2304	7030003440	S.RESISTOR	ERJ3GEYJ 102 V (1 kΩ)
R2306	7030005320	S.RESISTOR	RR0816P-103-D (10 kΩ)
R2307	7030003320	S.RESISTOR	ERJ3GEYJ 101 V (100 Ω)
R2308	7030005320	S.RESISTOR	RR0816P-103-D (10 kΩ)
R2309	7030003320	S.RESISTOR	ERJ3GEYJ 101 V (100 Ω)
R2321	7030009780	S.RESISTOR	RR0816Q-680-D (68 Ω)
R2322	7030009780	S.RESISTOR	RR0816Q-680-D (68 Ω)
R2323	7030009780	S.RESISTOR	RR0816Q-680-D (68 Ω)

S.=Surface mount

[DSP BOARD]

REF NO.	ORDER NO.	DESCRIPTION	
C2201	4030011600	S.CERAMIC	C1608 JB 1C 104KT-N
C2202	4030011600	S.CERAMIC	C1608 JB 1C 104KT-N
C2210	4510004630	S.ELECTROLYTIC	ECEV1CA100SR
C2211	4030006880	S.CERAMIC	C1608 JB 1H 472K-T-A
C2212	4030011600	S.CERAMIC	C1608 JB 1C 104KT-N
C2213	4030011600	S.CERAMIC	C1608 JB 1C 104KT-N
C2214	4510004630	S.ELECTROLYTIC	ECEV1CA100SR
C2215	4030011600	S.CERAMIC	C1608 JB 1C 104KT-N
C2216	4510004630	S.ELECTROLYTIC	ECEV1CA100SR
C2217	4030006860	S.CERAMIC	C1608 JB 1H 102K-T-A
C2218	4030006870	S.CERAMIC	C1608 JB 1H 222K-T-A
C2219	4030007170	S.CERAMIC	C1608 CH 1H 221J-T-A
C2220	4510004630	S.ELECTROLYTIC	ECEV1CA100SR
C2225	4030006870	S.CERAMIC	C1608 JB 1H 222K-T-A
C2256	4030011280	S.CERAMIC	C1608 CH 1H 271J-T-A
C2257	4030008470	S.CERAMIC	C1608 JB 1H 272K-T-A
C2258	4030011340	S.CERAMIC	C1608 CH 1H 471J-T-A
C2259	4030009580	S.CERAMIC	C1608 JB 1H 681K-T-A
C2260	4030007120	S.CERAMIC	C1608 CH 1H 820J-T-A
C2261	4030006880	S.CERAMIC	C1608 JB 1H 472K-T-A
C2262	4030010020	S.CERAMIC	C1608 JB 1H 122K-T-A
C2263	4030010040	S.CERAMIC	C1608 JB 1H 561K-T-A
C2283	4030011600	S.CERAMIC	C1608 JB 1C 104KT-N
C2284	4510004630	S.ELECTROLYTIC	ECEV1CA100SR
C2285	4030011600	S.CERAMIC	C1608 JB 1C 104KT-N
C2286	4510004630	S.ELECTROLYTIC	ECEV1CA100SR
C2291	4030011600	S.CERAMIC	C1608 JB 1C 104KT-N
C2292	4030011600	S.CERAMIC	C1608 JB 1C 104KT-N
C2301	4510004630	S.ELECTROLYTIC	ECEV1CA100SR
C2302	4030011600	S.CERAMIC	C1608 JB 1C 104KT-N
C2303	4510006220	S.ELECTROLYTIC	ECEV1CA101UP
C2306	4030011600	S.CERAMIC	C1608 JB 1C 104KT-N
C2307	4510004630	S.ELECTROLYTIC	ECEV1CA100SR
C2308	4510005890	S.ELECTROLYTIC	ECEV1AAN100R
C2309	4030011600	S.CERAMIC	C1608 JB 1C 104KT-N
C2310	4510004630	S.ELECTROLYTIC	ECEV1CA100SR
C2311	4030011810	S.CERAMIC	C1608 JB 1A 224K-T-N
C2321	4030009880	S.CERAMIC	C1608 JB 1H 682K-T-A
C2322	4030009880	S.CERAMIC	C1608 JB 1H 682K-T-A
C2323	4030011600	S.CERAMIC	C1608 JB 1C 104KT-N
C2324	4510004630	S.ELECTROLYTIC	ECEV1CA100SR
C2325	4030011600	S.CERAMIC	C1608 JB 1C 104KT-N
C2327	4030011600	S.CERAMIC	C1608 JB 1C 104KT-N
C2328	4510006220	S.ELECTROLYTIC	ECEV1CA101UP
C2329	4030011600	S.CERAMIC	C1608 JB 1C 104KT-N
C2330	4030011600	S.CERAMIC	C1608 JB 1C 104KT-N
C2331	4510006220	S.ELECTROLYTIC	ECEV1CA101UP
C2341	4030011600	S.CERAMIC	C1608 JB 1C 104KT-N
C2342	4030011600	S.CERAMIC	C1608 JB 1C 104KT-N
C2343	4030011600	S.CERAMIC	C1608 JB 1C 104KT-N
C2345	4030011600	S.CERAMIC	C1608 JB 1C 104KT-N
C2346	4030011600	S.CERAMIC	C1608 JB 1C 104KT-N
C2347	4030011600	S.CERAMIC	C1608 JB 1C 104KT-N
C2348	4030011600	S.CERAMIC	C1608 JB 1C 104KT-N
C2349	4030011600	S.CERAMIC	C1608 JB 1C 104KT-N
C2351	4030007010	S.CERAMIC	C1608 CH 1H 100D-T-A
C2352	4030007010	S.CERAMIC	C1608 CH 1H 100D-T-A
C2353	4510004630	S.ELECTROLYTIC	ECEV1CA100SR
C2354	4030011600	S.CERAMIC	C1608 JB 1C 104KT-N
C2355	4510004630	S.ELECTROLYTIC	ECEV1CA100SR
C2356	4030011600	S.CERAMIC	C1608 JB 1C 104KT-N
C2357	4510004630	S.ELECTROLYTIC	ECEV1CA100SR
C2358	4030011600	S.CERAMIC	C1608 JB 1C 104KT-N
C2359	4510004630	S.ELECTROLYTIC	ECEV1CA100SR
C2360	4030011600	S.CERAMIC	C1608 JB 1C 104KT-N
C2361	4030011600	S.CERAMIC	C1608 JB 1C 104KT-N
C2362	4030006880	S.CERAMIC	C1608 JB 1H 472K-T-A
C2363	4030006860	S.CERAMIC	C1608 JB 1H 102K-T-A
C2364	4030007170	S.CERAMIC	C1608 CH 1H 221J-T-A
C2365	4030006860	S.CERAMIC	C1608 JB 1H 102K-T-A
C2366	4030007170	S.CERAMIC	C1608 CH 1H 221J-T-A
C2372	4510004630	S.ELECTROLYTIC	ECEV1CA100SR
C2373	4030011600	S.CERAMIC	C1608 JB 1C 104KT-N
C2374	4510004630	S.ELECTROLYTIC	ECEV1CA100SR
C2375	4030011600	S.CERAMIC	C1608 JB 1C 104KT-N
C2376	4030011600	S.CERAMIC	C1608 JB 1C 104KT-N
C2377	4030011600	S.CERAMIC	C1608 JB 1C 104KT-N
C2378	4030011600	S.CERAMIC	C1608 JB 1C 104KT-N
C2379	4030011600	S.CERAMIC	C1608 JB 1C 104KT-N
C2380	4030011600	S.CERAMIC	C1608 JB 1C 104KT-N
C2381	4030010020	S.CERAMIC	C1608 JB 1H 122K-T-A
C2383	4030009980	S.CERAMIC	C1608 JB 1H 152K-T-A

[DSP BOARD]

REF NO.	ORDER NO.	DESCRIPTION	
C2385	4030011330	S.CERAMIC	C1608 CH 1H 391J-T-A
C2387	4030008470	S.CERAMIC	C1608 JB 1H 272K-T-A
C2389	4030011280	S.CERAMIC	C1608 CH 1H 271J-T-A
C2391	4510004630	S.ELECTROLYTIC	ECEV1CA100SR
C2392	4030011600	S.CERAMIC	C1608 JB 1C 104KT-N
C2393	4510004630	S.ELECTROLYTIC	ECEV1CA100SR
C2394	4030011600	S.CERAMIC	C1608 JB 1C 104KT-N
C2395	4030011810	S.CERAMIC	C1608 JB 1A 224K-T-N
C2401	4030009490	S.CERAMIC	C1608 JB 1H 821K-T-A
C2402	4030007150	S.CERAMIC	C1608 CH 1H 151J-T-A
C2403	4510004630	S.ELECTROLYTIC	ECEV1CA100SR
C2404	4030011600	S.CERAMIC	C1608 JB 1C 104KT-N
C2405	4510004630	S.ELECTROLYTIC	ECEV1CA100SR
C2406	4030011600	S.CERAMIC	C1608 JB 1C 104KT-N
C2407	4030007130	S.CERAMIC	C1608 CH 1H 101J-T-A
C2422	4030011600	S.CERAMIC	C1608 JB 1C 104KT-N
C2424	4030011600	S.CERAMIC	C1608 JB 1C 104KT-N
C2425	4030011810	S.CERAMIC	C1608 JB 1A 224K-T-N
C2442	4030011600	S.CERAMIC	C1608 JB 1C 104KT-N
C2443	4510005240	ELECTROLYTIC	16 MV 22 SWB
C2444	4030011600	S.CERAMIC	C1608 JB 1C 104KT-N
C2445	4510005240	ELECTROLYTIC	16 MV 22 SWB
C2446	4030006880	S.CERAMIC	C1608 JB 1H 472K-T-A
C2447	4030009580	S.CERAMIC	C1608 JB 1H 681K-T-A
C2448	4030009880	S.CERAMIC	C1608 JB 1H 682K-T-A
C2449	4030007160	S.CERAMIC	C1608 CH 1H 181J-T-A
C2450	4030006860	S.CERAMIC	C1608 JB 1H 102K-T-A
C2451	4030009580	S.CERAMIC	C1608 JB 1H 681K-T-A
C2452	4030009630	S.CERAMIC	C1608 JB 1H 822K-T-A
C2453	4030006880	S.CERAMIC	C1608 JB 1H 472K-T-A
C2454	4030010020	S.CERAMIC	C1608 JB 1H 122K-T-A
C2461	4510006220	S.ELECTROLYTIC	ECEV1CA101UP
C2462	4030011600	S.CERAMIC	C1608 JB 1C 104KT-N
C2463	4510004630	S.ELECTROLYTIC	ECEV1CA100SR
C2471	4030011600	S.CERAMIC	C1608 JB 1C 104KT-N
C2472	4030011600	S.CERAMIC	C1608 JB 1C 104KT-N
C2473	4030011600	S.CERAMIC	C1608 JB 1C 104KT-N
C2474	4030011600	S.CERAMIC	C1608 JB 1C 104KT-N
C2475	4030011600	S.CERAMIC	C1608 JB 1C 104KT-N
C2476	4030011600	S.CERAMIC	C1608 JB 1C 104KT-N
C2478	4030012600	S.CERAMIC	C2012 JB 1A 105M-T-A
C2479	4030006860	S.CERAMIC	C1608 JB 1H 102K-T-A
C2480	4510004630	S.ELECTROLYTIC	ECEV1CA100SR
C2501	4030011600	S.CERAMIC	C1608 JB 1C 104KT-N
C2502	4510004630	S.ELECTROLYTIC	ECEV1CA100SR
C2503	4510004630	S.ELECTROLYTIC	ECEV1CA100SR
C2504	4510004630	S.ELECTROLYTIC	ECEV1CA100SR
C2505	4510006220	S.ELECTROLYTIC	ECEV1CA101UP
C2507	4510006220	S.ELECTROLYTIC	ECEV1CA101UP
C2508	4030011600	S.CERAMIC	C1608 JB 1C 104KT-N
C2509	4510006220	S.ELECTROLYTIC	ECEV1CA101UP
C2510	4030011600	S.CERAMIC	C1608 JB 1C 104KT-N
C2511	4510006220	S.ELECTROLYTIC	ECEV1CA101UP
C2512	4030011600	S.CERAMIC	C1608 JB 1C 104KT-N
C2571	4030009000	S.CERAMIC	C2012 JB 1C 224K-T-A
C2572	4030008950	S.CERAMIC	C2012 JB 1C 823K-T-A
C2573	4030009000	S.CERAMIC	C2012 JB 1C 224K-T-A
C2574	4030008860	S.CERAMIC	C1608 JB 1C 153K-T-A
C2575	4030008950	S.CERAMIC	C2012 JB 1C 823K-T-A
C2576	4030009000	S.CERAMIC	C2012 JB 1C 224K-T-A
C2577	4030008860	S.CERAMIC	C1608 JB 1C 153K-T-A
C2578	4030011600	S.CERAMIC	C1608 JB 1C 104KT-N
C2579	4510004630	S.ELECTROLYTIC	ECEV1CA100SR
J2001	6510021650	CONNECTOR	IMSA-9180B-30B
J2002	6510021650	CONNECTOR	IMSA-9180B-30B
J2003	2610000390	CONNECTOR	IC-140-2806-BS4
MF1	2710000660	FAN	MFB30E12
W2201	7030003860	S.JUMPER	ERJ3GE JPW V
W2301	7030003860	S.JUMPER	ERJ3GE JPW V
W2302	7030003860	S.JUMPER	ERJ3GE JPW V
W2401	7030003860	S.JUMPER	ERJ3GE JPW V
W2402	7030003860	S.JUMPER	ERJ3GE JPW V
W2471	7030003860	S.JUMPER	ERJ3GE JPW V
W2501	7030003860	S.JUMPER	ERJ3GE JPW V
EP1	0910052253	PCB	B 5240C

S.=Surface mount

[MEMORY BOARD]

REF NO.	ORDER NO.	DESCRIPTION	
IC1	1140008630	S.IC	MBM29F400BC-90PFTN SC-1380
IC2	1140008470	S.IC	IDT71256SA20PZ
R1	7030003680	S.RESISTOR	ERJ3GEYJ 104 V (100 kΩ)
R2	7030003680	S.RESISTOR	ERJ3GEYJ 104 V (100 kΩ)
C1	4030011600	S.CERAMIC	C1608 JB 1C 104KT-N
C2	4030006860	S.CERAMIC	C1608 JB 1H 102K-T-A
C3	4550006250	S.TANTALUM	TEMSVA 1A 106M-8L
C4	4030011600	S.CERAMIC	C1608 JB 1C 104KT-N
J1	6510022070	S.CONNECTOR	AXK6S30635P
J2	6510022070	S.CONNECTOR	AXK6S30635P
EP1	6910012350	S.BEAD	MMZ1608Y 102BT
EP2	0910052263	PCB	B 5418C

[PLL UNIT]

REF NO.	ORDER NO.	DESCRIPTION	
IC1	1130007700	S.IC	BU4094BCF-T1
IC101	1140007880	S.IC	SC-1246A
IC102	1130003830	S.IC	TC7S04F (TE85R)
IC191	1130006440	S.IC	TC7S08F (TE85R)
IC192	1130006440	S.IC	TC7S08F (TE85R)
IC320	1110001890	S.IC	μPC1678G-E2
IC381	1130009230	S.IC	LMX2306TMX
IC382	1180000420	S.IC	TA78L05F (TE12R)
IC401	1140007880	S.IC	SC-1246A
IC402	1130003830	S.IC	TC7S04F (TE85R)
IC620	1110001890	S.IC	μPC1678G-E2
IC681	1130009230	S.IC	LMX2306TMX
IC682	1180000420	S.IC	TA78L05F (TE12R)
IC701	1140004550	S.IC	M65343FP/SC1287
IC801	1140004550	S.IC	M65343FP/SC1287
IC901	1130007660	S.IC	LC7153M-TLM
IC902	1130006800	S.IC	TC7W08F (TE12L)
Q2	1590002420	S.TRANSISTOR	UMD3N TL
Q51	1530002560	S.TRANSISTOR	2SC4403-3-TL
Q52	1530002060	S.TRANSISTOR	2SC4081 T107 R
Q71	1530002060	S.TRANSISTOR	2SC4081 T107 R
Q81	1530002570	S.TRANSISTOR	2SC4405-3-TL
Q102	1530002060	S.TRANSISTOR	2SC4081 T107 R
Q103	1530002060	S.TRANSISTOR	2SC4081 T107 R
Q121	1590002420	S.TRANSISTOR	UMD3N TL
Q122	1590002420	S.TRANSISTOR	UMD3N TL
Q123	1590002420	S.TRANSISTOR	UMD3N TL
Q124	1590002420	S.TRANSISTOR	UMD3N TL
Q126	1590002420	S.TRANSISTOR	UMD3N TL
Q151	1560000330	S.FET	2SK210-GR (TE85R)
Q152	1530002060	S.TRANSISTOR	2SC4081 T107 R
Q181	1530002060	S.TRANSISTOR	2SC4081 T107 R
Q201	1560000490	S.FET	2SK508 K52 T2B
Q202	1530003090	S.TRANSISTOR	2SC4213-B (TE85R)
Q221	1560000490	S.FET	2SK508 K52 T2B
Q222	1530003090	S.TRANSISTOR	2SC4213-B (TE85R)
Q251	1560000490	S.FET	2SK508 K52 T2B
Q252	1530003090	S.TRANSISTOR	2SC4213-B (TE85R)
Q271	1560000490	S.FET	2SK508 K52 T2B
Q272	1530003090	S.TRANSISTOR	2SC4213-B (TE85R)
Q301	1530002560	S.TRANSISTOR	2SC4403-3-TL
Q351	1590001870	S.TRANSISTOR	DTA114EE TL
Q361	1590002310	S.TRANSISTOR	DTC114EE TL
Q402	1530002060	S.TRANSISTOR	2SC4081 T107 R
Q403	1530002060	S.TRANSISTOR	2SC4081 T107 R
Q421	1590002420	S.TRANSISTOR	UMD3N TL
Q422	1590002420	S.TRANSISTOR	UMD3N TL
Q423	1590002420	S.TRANSISTOR	UMD3N TL
Q424	1590002420	S.TRANSISTOR	UMD3N TL
Q425	1590001870	S.TRANSISTOR	DTA114EE TL
Q426	1590002420	S.TRANSISTOR	UMD3N TL

[PLL UNIT]

REF NO.	ORDER NO.	DESCRIPTION	
Q451	1560000330	S.FET	2SK210-GR (TE85R)
Q452	1530002060	S.TRANSISTOR	2SC4081 T107 R
Q481	1530002060	S.TRANSISTOR	2SC4081 T107 R
Q501	1560000490	S.FET	2SK508 K52 T2B
Q502	1530003090	S.TRANSISTOR	2SC4213-B (TE85R)
Q521	1560000490	S.FET	2SK508 K52 T2B
Q522	1530003090	S.TRANSISTOR	2SC4213-B (TE85R)
Q551	1560000490	S.FET	2SK508 K52 T2B
Q552	1530003090	S.TRANSISTOR	2SC4213-B (TE85R)
Q571	1560000490	S.FET	2SK508 K52 T2B
Q572	1530003090	S.TRANSISTOR	2SC4213-B (TE85R)
Q601	1530002560	S.TRANSISTOR	2SC4403-3-TL
Q651	1590001870	S.TRANSISTOR	DTA114EE TL
Q661	1590002310	S.TRANSISTOR	DTC114EE TL
Q681	1510000510	S.TRANSISTOR	2SA1576A T106R
Q701	1530002060	S.TRANSISTOR	2SC4081 T107 R
Q801	1530002060	S.TRANSISTOR	2SC4081 T107 R
Q802	1530003010	S.TRANSISTOR	2SC4117-GR (TE85R)
Q902	1560000490	S.FET	2SK508 K52 T2B
Q903	1530003010	S.TRANSISTOR	2SC4117-GR (TE85R)
Q904	1530002370	S.TRANSISTOR	2SC2714-O (TE85R)
Q905	1590002310	S.TRANSISTOR	DTC114EE TL
Q906	1590000980	S.TRANSISTOR	DTB123EK T147
Q907	1590002310	S.TRANSISTOR	DTC114EE TL
D2	1160000140	S.DIODE	DAP222 TL
D3	1750000520	S.DIODE	DAN222TL
D4	1750000520	S.DIODE	DAN222TL
D51	1720000390	S.VARICAP	KV1470TL
D151	1720000590	S.VARICAP	MA357 (TX)
D152	1790000490	S.DIODE	HSM88AS-TR
D153	1790000490	S.DIODE	HSM88AS-TR
D201	1720000390	S.VARICAP	KV1470TL
D202	1720000390	S.VARICAP	KV1470TL
D221	1720000390	S.VARICAP	KV1470TL
D222	1720000390	S.VARICAP	KV1470TL
D251	1790000540	S.VARICAP	MA338 (TX)
D252	1790000540	S.VARICAP	MA338 (TX)
D253	1790000540	S.VARICAP	MA338 (TX)
D254	1790000540	S.VARICAP	MA338 (TX)
D271	1790000540	S.VARICAP	MA338 (TX)
D272	1790000540	S.VARICAP	MA338 (TX)
D273	1790000540	S.VARICAP	MA338 (TX)
D274	1790000540	S.VARICAP	MA338 (TX)
D301	1790000620	S.DIODE	MA77 (TX)
D351	1790000620	S.DIODE	MA77 (TX)
D361	1790000450	S.DIODE	MA862 (TX)
D380	1790000620	S.DIODE	MA77 (TX)
D451	1720000590	S.VARICAP	MA357 (TX)
D452	1790000490	S.DIODE	HSM88AS-TR
D453	1790000490	S.DIODE	HSM88AS-TR
D501	1720000390	S.VARICAP	KV1470TL
D502	1720000390	S.VARICAP	KV1470TL
D521	1720000390	S.VARICAP	KV1470TL
D522	1720000390	S.VARICAP	KV1470TL
D551	1790000540	S.VARICAP	MA338 (TX)
D552	1790000540	S.VARICAP	MA338 (TX)
D553	1790000540	S.VARICAP	MA338 (TX)
D554	1790000540	S.VARICAP	MA338 (TX)
D571	1790000540	S.VARICAP	MA338 (TX)
D572	1790000540	S.VARICAP	MA338 (TX)
D573	1790000540	S.VARICAP	MA338 (TX)
D574	1790000540	S.VARICAP	MA338 (TX)
D601	1790000620	S.DIODE	MA77 (TX)
D651	1790000620	S.DIODE	MA77 (TX)
D661	1790000450	S.DIODE	MA862 (TX)
D680	1790000620	S.DIODE	MA77 (TX)
D901	1720000590	S.VARICAP	MA357 (TX)
D902	1750000070	S.DIODE	1S5226 (TE85R)
FI101	2020001690	S.CERAMIC	CFEC10.8MD11
FI401	2020001690	S.CERAMIC	CFEC10.8MD11
X52	6050008870	XTAL	CR-338 POCO (32.00056 MHz)
L1	6200003950	S.COIL	HF50ACC 322513-T
L2	6200003950	S.COIL	HF50ACC 322513-T
L31	6200003950	S.COIL	EXCL3225U1

S.=Surface mount

[PLL UNIT]

REF NO.	ORDER NO.	DESCRIPTION	
L51	6200008910	S.COIL	1812CS-122XKBC
L52	6150004370	COIL	LS-472C
L55	6200001830	S.COIL	NL 322522T-100J
L81	6150004830	S.COIL	LS-509
L82	6150004830	S.COIL	LS-509
L101	6200001830	S.COIL	NL 322522T-100J
L121	6200001830	S.COIL	NL 322522T-100J
L122	6200001830	S.COIL	NL 322522T-100J
L123	6200001830	S.COIL	NL 322522T-100J
L124	6200001830	S.COIL	NL 322522T-100J
L125	6200001830	S.COIL	NL 322522T-100J
L126	6200001830	S.COIL	NL 322522T-100J
L128	6200001830	S.COIL	NL 322522T-100J
L152	6130002970	COIL	LB-343
L153	6200001830	S.COIL	NL 322522T-100J
L181	6200001830	S.COIL	NL 322522T-100J
L202	6190001410	COIL	E526GN-110501
L204	6200003260	S.COIL	NL 322522T-101J
L205	6200008910	S.COIL	1812CS-122XKBC
L206	6200008910	S.COIL	1812CS-122XKBC
L222	6190001410	COIL	E526GN-110501
L224	6200003260	S.COIL	NL 322522T-101J
L225	6200008910	S.COIL	1812CS-122XKBC
L226	6200008910	S.COIL	1812CS-122XKBC
L252	6190001420	COIL	E526GN-110502
L254	6200003260	S.COIL	NL 322522T-101J
L255	6200008910	S.COIL	1812CS-122XKBC
L256	6200008910	S.COIL	1812CS-122XKBC
L272	6190001440	COIL	E526GN-110504
L274	6200003260	S.COIL	NL 322522T-101J
L275	6200008910	S.COIL	1812CS-122XKBC
L276	6200008910	S.COIL	1812CS-122XKBC
L301	6200001830	S.COIL	NL 322522T-100J
L303	6200004030	S.COIL	NL 322522T-047J
L304	6200002960	S.COIL	NL 322522T-4R7J-3
L320	6200004590	S.COIL	MLF1608D R18K-T
L321	6200003020	S.COIL	NL 322522T-R33J-3
L351	6200002410	S.COIL	NL 252018T-056J
L352	6200002430	S.COIL	NL 252018T-082J
L353	6200002430	S.COIL	NL 252018T-082J
L354	6200003420	S.COIL	NL 322522T-R15J-3
L355	6200000880	S.COIL	NL 322522T-4R7M
L357	6200003160	S.COIL	NL 322522T-270J
L382	6200003950	S.COIL	HF50ACC 322513-T
L401	6200001830	S.COIL	NL 322522T-100J
L421	6200001830	S.COIL	NL 322522T-100J
L422	6200001830	S.COIL	NL 322522T-100J
L423	6200001830	S.COIL	NL 322522T-100J
L424	6200001830	S.COIL	NL 322522T-100J
L425	6200001830	S.COIL	NL 322522T-100J
L426	6200001830	S.COIL	NL 322522T-100J
L428	6200001830	S.COIL	NL 322522T-100J
L452	6130002970	COIL	LB-343
L453	6200001830	S.COIL	NL 322522T-100J
L481	6200001830	S.COIL	NL 322522T-100J
L491	6200003040	S.COIL	NL 322522T-R68J-3
L492	6200003050	S.COIL	NL 322522T-R82J-3
L502	6190001410	COIL	E526GN-110501
L504	6200003260	S.COIL	NL 322522T-101J
L505	6200008910	S.COIL	1812CS-122XKBC
L506	6200008910	S.COIL	1812CS-122XKBC
L522	6190001410	COIL	E526GN-110501
L524	6200003260	S.COIL	NL 322522T-101J
L525	6200008910	S.COIL	1812CS-122XKBC
L526	6200008910	S.COIL	1812CS-122XKBC
L552	6190001420	COIL	E526GN-110502
L554	6200003260	S.COIL	NL 322522T-101J
L555	6200008910	S.COIL	1812CS-122XKBC
L556	6200008910	S.COIL	1812CS-122XKBC
L572	6190001440	COIL	E526GN-110504
L574	6200003260	S.COIL	NL 322522T-101J
L575	6200008910	S.COIL	1812CS-122XKBC
L576	6200008910	S.COIL	1812CS-122XKBC
L601	6200001830	S.COIL	NL 322522T-100J
L603	6200004030	S.COIL	NL 322522T-047J
L604	6200000880	S.COIL	NL 322522T-4R7M
L620	6200004590	S.COIL	MLF1608D R18K-T
L621	6200003020	S.COIL	NL 322522T-R33J-3
L651	6200002410	S.COIL	NL 252018T-056J
L652	6200002430	S.COIL	NL 252018T-082J
L653	6200002430	S.COIL	NL 252018T-082J
L654	6200003420	S.COIL	NL 322522T-R15J-3

[PLL UNIT]

REF NO.	ORDER NO.	DESCRIPTION	
L655	6200002960	S.COIL	NL 322522T-4R7J-3
L657	6200003160	S.COIL	NL 322522T-270J
L682	6200003950	S.COIL	HF50ACC 322513-T
L701	6200001830	S.COIL	NL 322522T-100J
L702	6200005490	S.COIL	NL 322522T-331J
L703	6200008640	S.COIL	NL 322522T-391J
L704	6200008640	S.COIL	NL 322522T-391J
L801	6200001830	S.COIL	NL 322522T-100J
L802	6200001830	S.COIL	NL 322522T-100J
L803	6200003130	S.COIL	NL 322522T-120J
L804	6200003170	S.COIL	NL 322522T-330J
L806	6200002980	S.COIL	NL 322522T-R56J-3
L901	6200003260	S.COIL	NL 322522T-101J
L902	6200004950	S.COIL	NL 252018T-1R8J
L903	6200003260	S.COIL	NL 322522T-101J
L904	6190000950	COIL	C-13975-6.5T
L905	6200003660	S.COIL	NL 252018T-R68J
L906	6200003260	S.COIL	NL 322522T-101J
L907	6200002630	S.COIL	NL 252018T-R10J
L908	6200002180	S.COIL	NL 252018T-R12J
L909	6200003260	S.COIL	NL 322522T-101J
L910	6200004960	S.COIL	NL 252018T-R33J
R1	7030003440	S.RESISTOR	ERJ3GEYJ 102 V (1 kΩ)
R2	7030003440	S.RESISTOR	ERJ3GEYJ 102 V (1 kΩ)
R3	7030003280	S.RESISTOR	ERJ3GEYJ 470 V (47 Ω)
R4	7030003280	S.RESISTOR	ERJ3GEYJ 470 V (47 Ω)
R5	7030003440	S.RESISTOR	ERJ3GEYJ 102 V (1 kΩ)
R8	7030003440	S.RESISTOR	ERJ3GEYJ 102 V (1 kΩ)
R9	7030003440	S.RESISTOR	ERJ3GEYJ 102 V (1 kΩ)
R10	7030003640	S.RESISTOR	ERJ3GEYJ 473 V (47 kΩ)
R11	7030003640	S.RESISTOR	ERJ3GEYJ 473 V (47 kΩ)
R12	7030003640	S.RESISTOR	ERJ3GEYJ 473 V (47 kΩ)
R13	7030003640	S.RESISTOR	ERJ3GEYJ 473 V (47 kΩ)
R14	7030003640	S.RESISTOR	ERJ3GEYJ 473 V (47 kΩ)
R15	7030003560	S.RESISTOR	ERJ3GEYJ 103 V (10 kΩ)
R32	7310003820	TRIMMER	EVN-D2AA03 B14
R33	7310002720	S.TRIMMER	RV-148 (472)
R36	7030003640	S.RESISTOR	ERJ3GEYJ 473 V (47 kΩ)
R40	7030003550	S.RESISTOR	ERJ3GEYJ 822 V (8.2 kΩ)
R41	7030003550	S.RESISTOR	ERJ3GEYJ 822 V (8.2 kΩ)
R42	7030003550	S.RESISTOR	ERJ3GEYJ 822 V (8.2 kΩ)
R43	7030003550	S.RESISTOR	ERJ3GEYJ 822 V (8.2 kΩ)
R44	7030003550	S.RESISTOR	ERJ3GEYJ 822 V (8.2 kΩ)
R45	7030003550	S.RESISTOR	ERJ3GEYJ 822 V (8.2 kΩ)
R46	7030003550	S.RESISTOR	ERJ3GEYJ 822 V (8.2 kΩ)
R47	7030003440	S.RESISTOR	ERJ3GEYJ 102 V (1 kΩ)
R48	7030003440	S.RESISTOR	ERJ3GEYJ 102 V (1 kΩ)
R51	7030003640	S.RESISTOR	ERJ3GEYJ 473 V (47 kΩ)
R52	7030003580	S.RESISTOR	ERJ3GEYJ 153 V (15 kΩ)
R53	7030003520	S.RESISTOR	ERJ3GEYJ 472 V (4.7 kΩ)
R54	7030003400	S.RESISTOR	ERJ3GEYJ 471 V (470 Ω)
R55	7030003280	S.RESISTOR	ERJ3GEYJ 470 V (47 Ω)
R57	7030003440	S.RESISTOR	ERJ3GEYJ 102 V (1 kΩ)
R58	7030003610	S.RESISTOR	ERJ3GEYJ 273 V (27 kΩ)
R60	7030003380	S.RESISTOR	ERJ3GEYJ 331 V (330 Ω)
R61	7030003360	S.RESISTOR	ERJ3GEYJ 221 V (220 Ω)
R62	7030003260	S.RESISTOR	ERJ3GEYJ 330 V (33 Ω)
R63	7030003420	S.RESISTOR	ERJ3GEYJ 681 V (680 Ω)
R71	7030003640	S.RESISTOR	ERJ3GEYJ 473 V (47 kΩ)
R72	7030003380	S.RESISTOR	ERJ3GEYJ 331 V (330 Ω)
R81	7030003600	S.RESISTOR	ERJ3GEYJ 223 V (22 kΩ)
R82	7030003560	S.RESISTOR	ERJ3GEYJ 103 V (10 kΩ)
R83	7030003370	S.RESISTOR	ERJ3GEYJ 271 V (270 Ω)
R84	7030003320	S.RESISTOR	ERJ3GEYJ 101 V (100 Ω)
R85	7030003350	S.RESISTOR	ERJ3GEYJ 181 V (180 Ω)
R86	7030003350	S.RESISTOR	ERJ3GEYJ 181 V (180 Ω)
R87	7030003220	S.RESISTOR	ERJ3GEYJ 150 V (15 Ω)
R89	7030003260	S.RESISTOR	ERJ3GEYJ 330 V (33 Ω)
R101	7030005400	S.RESISTOR	RR0816P-202-D (2 kΩ)
R102	7030005400	S.RESISTOR	RR0816P-202-D (2 kΩ)
R103	7030005390	S.RESISTOR	RR0816P-102-D (1 kΩ)
R104	7030005400	S.RESISTOR	RR0816P-202-D (2 kΩ)
R105	7030005390	S.RESISTOR	RR0816P-102-D (1 kΩ)
R106	7030005400	S.RESISTOR	RR0816P-202-D (2 kΩ)
R107	7030005390	S.RESISTOR	RR0816P-102-D (1 kΩ)
R108	7030005400	S.RESISTOR	RR0816P-202-D (2 kΩ)
R109	7030005390	S.RESISTOR	RR0816P-102-D (1 kΩ)
R110	7030005400	S.RESISTOR	RR0816P-202-D (2 kΩ)
R111	7030005390	S.RESISTOR	RR0816P-102-D (1 kΩ)
R112	7030005400	S.RESISTOR	RR0816P-202-D (2 kΩ)

S.=Surface mount

[PLL UNIT]

REF NO.	ORDER NO.	DESCRIPTION	
R623	7030003200	S.RESISTOR	ERJ3GEYJ 100 V (10 Ω)
R650	7030003470	S.RESISTOR	ERJ3GEYJ 182 V (1.8 kΩ)
R651	7030003490	S.RESISTOR	ERJ3GEYJ 272 V (2.7 kΩ)
R652	7030003370	S.RESISTOR	ERJ3GEYJ 271 V (270 Ω)
R653	7030003230	S.RESISTOR	ERJ3GEYJ 180 V (18 Ω)
R654	7030003370	S.RESISTOR	ERJ3GEYJ 271 V (270 Ω)
R655	7030003320	S.RESISTOR	ERJ3GEYJ 101 V (100 Ω)
R656	7030003640	S.RESISTOR	ERJ3GEYJ 473 V (47 kΩ)
R660	7030003220	S.RESISTOR	ERJ3GEYJ 150 V (15 Ω)
R661	7030003560	S.RESISTOR	ERJ3GEYJ 103 V (10 kΩ)
R662	7030003320	S.RESISTOR	ERJ3GEYJ 101 V (100 Ω)
R663	7030003560	S.RESISTOR	ERJ3GEYJ 103 V (10 kΩ)
R669	7030003590	S.RESISTOR	ERJ3GEYJ 183 V (18 kΩ)
R680	7030003560	S.RESISTOR	ERJ3GEYJ 103 V (10 kΩ)
R681	7030003320	S.RESISTOR	ERJ3GEYJ 101 V (100 Ω)
R685	7030003440	S.RESISTOR	ERJ3GEYJ 102 V (1 kΩ)
R686	7030003440	S.RESISTOR	ERJ3GEYJ 102 V (1 kΩ)
R687	7030003440	S.RESISTOR	ERJ3GEYJ 102 V (1 kΩ)
R688	7030003670	S.RESISTOR	ERJ3GEYJ 823 V (82 kΩ)
R693	7030009650	S.RESISTOR	RR0816Q-820-D (82 Ω)
R694	7030005350	S.RESISTOR	RR0816P-182-D (1.8 kΩ)
R701	7030005400	S.RESISTOR	RR0816P-202-D (2 kΩ)
R702	7030005390	S.RESISTOR	RR0816P-102-D (1 kΩ)
R703	7030005400	S.RESISTOR	RR0816P-202-D (2 kΩ)
R704	7030005390	S.RESISTOR	RR0816P-102-D (1 kΩ)
R705	7030005400	S.RESISTOR	RR0816P-202-D (2 kΩ)
R706	7030005390	S.RESISTOR	RR0816P-102-D (1 kΩ)
R707	7030005400	S.RESISTOR	RR0816P-202-D (2 kΩ)
R708	7030005390	S.RESISTOR	RR0816P-102-D (1 kΩ)
R709	7030005370	S.RESISTOR	RR0816P-202-B (2 kΩ)
R710	7030005380	S.RESISTOR	RR0816P-102-B (1 kΩ)
R711	7030005370	S.RESISTOR	RR0816P-202-B (2 kΩ)
R712	7030005380	S.RESISTOR	RR0816P-102-B (1 kΩ)
R713	7030005370	S.RESISTOR	RR0816P-202-B (2 kΩ)
R714	7030005380	S.RESISTOR	RR0816P-102-B (1 kΩ)
R715	7030005370	S.RESISTOR	RR0816P-202-B (2 kΩ)
R716	7030005380	S.RESISTOR	RR0816P-102-B (1 kΩ)
R717	7030005370	S.RESISTOR	RR0816P-202-B (2 kΩ)
R718	7030005380	S.RESISTOR	RR0816P-102-B (1 kΩ)
R719	7030005370	S.RESISTOR	RR0816P-202-B (2 kΩ)
R720	7030005370	S.RESISTOR	RR0816P-202-B (2 kΩ)
R721	7030003640	S.RESISTOR	ERJ3GEYJ 473 V (47 kΩ)
R722	7030003370	S.RESISTOR	ERJ3GEYJ 271 V (270 Ω)
R724	7030003480	S.RESISTOR	ERJ3GEYJ 222 V (2.2 kΩ)
R727	7030003440	S.RESISTOR	ERJ3GEYJ 102 V (1 kΩ)
R728	7030003440	S.RESISTOR	ERJ3GEYJ 102 V (1 kΩ)
R729	7030003440	S.RESISTOR	ERJ3GEYJ 102 V (1 kΩ)
R730	7030003440	S.RESISTOR	ERJ3GEYJ 102 V (1 kΩ)
R801	7030005400	S.RESISTOR	RR0816P-202-D (2 kΩ)
R802	7030005390	S.RESISTOR	RR0816P-102-D (1 kΩ)
R803	7030005400	S.RESISTOR	RR0816P-202-D (2 kΩ)
R804	7030005390	S.RESISTOR	RR0816P-102-D (1 kΩ)
R805	7030005400	S.RESISTOR	RR0816P-202-D (2 kΩ)
R806	7030005390	S.RESISTOR	RR0816P-102-D (1 kΩ)
R807	7030005400	S.RESISTOR	RR0816P-202-D (2 kΩ)
R808	7030005390	S.RESISTOR	RR0816P-102-D (1 kΩ)
R809	7030005370	S.RESISTOR	RR0816P-202-B (2 kΩ)
R810	7030005380	S.RESISTOR	RR0816P-102-B (1 kΩ)
R811	7030005370	S.RESISTOR	RR0816P-202-B (2 kΩ)
R812	7030005380	S.RESISTOR	RR0816P-102-B (1 kΩ)
R813	7030005370	S.RESISTOR	RR0816P-202-B (2 kΩ)
R814	7030005380	S.RESISTOR	RR0816P-102-B (1 kΩ)
R815	7030005370	S.RESISTOR	RR0816P-202-B (2 kΩ)
R816	7030005380	S.RESISTOR	RR0816P-102-B (1 kΩ)
R817	7030005370	S.RESISTOR	RR0816P-202-B (2 kΩ)
R818	7030005380	S.RESISTOR	RR0816P-102-B (1 kΩ)
R819	7030005370	S.RESISTOR	RR0816P-202-B (2 kΩ)
R820	7030005370	S.RESISTOR	RR0816P-202-B (2 kΩ)
R821	7030003630	S.RESISTOR	ERJ3GEYJ 393 V (39 kΩ)
R822	7030003350	S.RESISTOR	ERJ3GEYJ 181 V (180 Ω)
R823	7030003470	S.RESISTOR	ERJ3GEYJ 182 V (1.8 kΩ)
R824	7030003480	S.RESISTOR	ERJ3GEYJ 222 V (2.2 kΩ)
R825	7030003360	S.RESISTOR	ERJ3GEYJ 221 V (220 Ω)
R826	7030003320	S.RESISTOR	ERJ3GEYJ 101 V (100 Ω)
R827	7030003440	S.RESISTOR	ERJ3GEYJ 102 V (1 kΩ)
R828	7030003440	S.RESISTOR	ERJ3GEYJ 102 V (1 kΩ)
R829	7030003440	S.RESISTOR	ERJ3GEYJ 102 V (1 kΩ)
R830	7030003440	S.RESISTOR	ERJ3GEYJ 102 V (1 kΩ)
R901	7030003440	S.RESISTOR	ERJ3GEYJ 102 V (1 kΩ)
R902	7030003440	S.RESISTOR	ERJ3GEYJ 102 V (1 kΩ)
R903	7030003440	S.RESISTOR	ERJ3GEYJ 102 V (1 kΩ)
R904	7030003560	S.RESISTOR	ERJ3GEYJ 103 V (10 kΩ)

[PLL UNIT]

REF NO.	ORDER NO.	DESCRIPTION	
R906	7030003280	S.RESISTOR	ERJ3GEYJ 470 V (47 Ω)
R907	7030003650	S.RESISTOR	ERJ3GEYJ 563 V (56 kΩ)
R908	7030003840	S.RESISTOR	ERJ3GEYJ 225 V (2.2 MΩ)
R909	7030003460	S.RESISTOR	ERJ3GEYJ 152 V (1.5 kΩ)
R910	7030003520	S.RESISTOR	ERJ3GEYJ 472 V (4.7 kΩ)
R911	7030003440	S.RESISTOR	ERJ3GEYJ 102 V (1 kΩ)
R912	7030003440	S.RESISTOR	ERJ3GEYJ 102 V (1 kΩ)
R913	7030003680	S.RESISTOR	ERJ3GEYJ 104 V (100 kΩ)
R914	7030003680	S.RESISTOR	ERJ3GEYJ 104 V (100 kΩ)
R915	7030003320	S.RESISTOR	ERJ3GEYJ 101 V (100 Ω)
R916	7030003340	S.RESISTOR	ERJ3GEYJ 151 V (150 Ω)
R917	7030003320	S.RESISTOR	ERJ3GEYJ 101 V (100 Ω)
R918	7030003680	S.RESISTOR	ERJ3GEYJ 104 V (100 kΩ)
R919	7030003440	S.RESISTOR	ERJ3GEYJ 102 V (1 kΩ)
R920	7030003280	S.RESISTOR	ERJ3GEYJ 470 V (47 Ω)
R921	7030003280	S.RESISTOR	ERJ3GEYJ 470 V (47 Ω)
R922	7030003320	S.RESISTOR	ERJ3GEYJ 101 V (100 Ω)
R923	7030003530	S.RESISTOR	ERJ3GEYJ 562 V (5.6 kΩ)
R924	7030003420	S.RESISTOR	ERJ3GEYJ 681 V (680 Ω)
R925	7030003200	S.RESISTOR	ERJ3GEYJ 100 V (10 Ω)
C1	4030006880	S.CERAMIC	C1608 JB 1H 472K-T-A
C2	4550006080	S.TANTALUM	TEMSVB2 1C 106M-8L
C3	4030006880	S.CERAMIC	C1608 JB 1H 472K-T-A
C4	4550006080	S.TANTALUM	TEMSVB2 1C 106M-8L
C5	4030011600	S.CERAMIC	C1608 JB 1C 104KT-N
C31	4030006880	S.CERAMIC	C1608 JB 1H 472K-T-A
C32	4030006880	S.CERAMIC	C1608 JB 1H 472K-T-A
C33	4550002810	S.TANTALUM	TESVD2 1E 106M-12L
C40	4030007050	S.CERAMIC	C1608 CH 1H 220J-T-A
C41	4030007050	S.CERAMIC	C1608 CH 1H 220J-T-A
C50	4030006880	S.CERAMIC	C1608 JB 1H 472K-T-A
C51	4030007020	S.CERAMIC	C1608 CH 1H 120J-T-A
C53	4030007120	S.CERAMIC	C1608 CH 1H 820J-T-A
C54	4030006880	S.CERAMIC	C1608 JB 1H 472K-T-A
C56	4030006880	S.CERAMIC	C1608 JB 1H 472K-T-A
C58	4030007400	S.CERAMIC	C1608 PH 1H 121J-T-A
C64	4030006880	S.CERAMIC	C1608 JB 1H 472K-T-A
C65	4030011600	S.CERAMIC	C1608 JB 1C 104KT-N
C71	4030006880	S.CERAMIC	C1608 JB 1H 472K-T-A
C81	4030006880	S.CERAMIC	C1608 JB 1H 472K-T-A
C82	4030007170	S.CERAMIC	C1608 CH 1H 221J-T-A
C83	4030007050	S.CERAMIC	C1608 CH 1H 220J-T-A
C84	4030006880	S.CERAMIC	C1608 JB 1H 472K-T-A
C85	4030009510	S.CERAMIC	C1608 CH 1H 010B-T-A
C86	4030007050	S.CERAMIC	C1608 CH 1H 220J-T-A
C87	4030006880	S.CERAMIC	C1608 JB 1H 472K-T-A
C88	4030006880	S.CERAMIC	C1608 JB 1H 472K-T-A
C101	4550006080	S.TANTALUM	TEMSVB2 1C 106M-8L
C102	4030011600	S.CERAMIC	C1608 JB 1C 104KT-N
C103	4030011600	S.CERAMIC	C1608 JB 1C 104KT-N
C104	4030011600	S.CERAMIC	C1608 JB 1C 104KT-N
C105	4030011600	S.CERAMIC	C1608 JB 1C 104KT-N
C106	4030011600	S.CERAMIC	C1608 JB 1C 104KT-N
C107	4030011600	S.CERAMIC	C1608 JB 1C 104KT-N
C108	4030011600	S.CERAMIC	C1608 JB 1C 104KT-N
C109	4030011600	S.CERAMIC	C1608 JB 1C 104KT-N
C110	4030011600	S.CERAMIC	C1608 JB 1C 104KT-N
C111	4030011600	S.CERAMIC	C1608 JB 1C 104KT-N
C112	4030011600	S.CERAMIC	C1608 JB 1C 104KT-N
C113	4030011600	S.CERAMIC	C1608 JB 1C 104KT-N
C114	4030011600	S.CERAMIC	C1608 JB 1C 104KT-N
C115	4030011600	S.CERAMIC	C1608 JB 1C 104KT-N
C116	4030011600	S.CERAMIC	C1608 JB 1C 104KT-N
C117	4030011600	S.CERAMIC	C1608 JB 1C 104KT-N
C118	4030011600	S.CERAMIC	C1608 JB 1C 104KT-N
C119	4030006880	S.CERAMIC	C1608 JB 1H 472K-T-A
C120	4030011600	S.CERAMIC	C1608 JB 1C 104KT-N
C121	4550006250	S.TANTALUM	TEMSVA 1A 106M-8L
C122	4030006880	S.CERAMIC	C1608 JB 1H 472K-T-A
C123	4030006880	S.CERAMIC	C1608 JB 1H 472K-T-A
C124	4030006880	S.CERAMIC	C1608 JB 1H 472K-T-A
C125	4030006880	S.CERAMIC	C1608 JB 1H 472K-T-A
C126	4030006880	S.CERAMIC	C1608 JB 1H 472K-T-A
C127	4030006880	S.CERAMIC	C1608 JB 1H 472K-T-A
C128	4030006880	S.CERAMIC	C1608 JB 1H 472K-T-A
C129	4030006880	S.CERAMIC	C1608 JB 1H 472K-T-A
C130	4030006880	S.CERAMIC	C1608 JB 1H 472K-T-A
C131	4030012600	S.CERAMIC	C2012 JB 1A 105M-T-A
C137	4030006880	S.CERAMIC	C1608 JB 1H 472K-T-A
C138	4030006880	S.CERAMIC	C1608 JB 1H 472K-T-A

S.=Surface mount

[PLL UNIT]

REF NO.	ORDER NO.	DESCRIPTION
C139	4030006880	S.CERAMIC C1608 JB 1H 472K-T-A
C147	4030006880	S.CERAMIC C1608 JB 1H 472K-T-A
C150	4030011600	S.CERAMIC C1608 JB 1C 104KT-N
C151	4030006880	S.CERAMIC C1608 JB 1H 472K-T-A
C152	4030007070	S.CERAMIC C1608 CH 1H 330J-T-A
C153	4030009910	S.CERAMIC C1608 CH 1H 040B-T-A
C154	4610001850	S.TRIMMER TZBX4R200BA110T00 20P
C155	4030016550	S.CERAMIC CM105 CH 151G 50AT
C156	4030016550	S.CERAMIC CM105 CH 151G 50AT
C157	4030016550	S.CERAMIC CM105 CH 151G 50AT
C158	4550006080	S.TANTALUM TEMSVB2 1C 106M-8L
C159	4030006880	S.CERAMIC C1608 JB 1H 472K-T-A
C160	4030006880	S.CERAMIC C1608 JB 1H 472K-T-A
C161	4030009920	S.CERAMIC C1608 CH 1H 050B-T-A
C162	4030011600	S.CERAMIC C1608 JB 1C 104KT-N
C163	4030006880	S.CERAMIC C1608 JB 1H 472K-T-A
C172	4030006990	S.CERAMIC C1608 CH 1H 080D-T-A
C173	4030007030	S.CERAMIC C1608 CH 1H 150J-T-A
C174	4030007060	S.CERAMIC C1608 CH 1H 270J-T-A
C181	4030006880	S.CERAMIC C1608 JB 1H 472K-T-A
C182	4550006080	S.TANTALUM TEMSVB2 1C 106M-8L
C183	4030006880	S.CERAMIC C1608 JB 1H 472K-T-A
C191	4030011600	S.CERAMIC C1608 JB 1C 104KT-N
C192	4030011600	S.CERAMIC C1608 JB 1C 104KT-N
C201	4030006880	S.CERAMIC C1608 JB 1H 472K-T-A
C202	4030009990	S.CERAMIC C1608 CH 1H 200J-T-A
C203	4030006880	S.CERAMIC C1608 JB 1H 472K-T-A
C204	4030011340	S.CERAMIC C1608 CH 1H 471J-T-A
C205	4030006880	S.CERAMIC C1608 JB 1H 472K-T-A
C206	4030009510	S.CERAMIC C1608 CH 1H 010B-T-A
C207	4030006880	S.CERAMIC C1608 JB 1H 472K-T-A
C208	4610001860	S.TRIMMER TZBX4Z060BA110T00 6P
C209	4030009350	S.CERAMIC C1608 CH 1H 3R5B-T-A
C222	4030007100	S.CERAMIC C1608 CH 1H 560J-T-A
C223	4030006880	S.CERAMIC C1608 JB 1H 472K-T-A
C224	4030011340	S.CERAMIC C1608 CH 1H 471J-T-A
C225	4030006880	S.CERAMIC C1608 JB 1H 472K-T-A
C226	4030006920	S.CERAMIC C1608 CH 1H 010C-T-A
C227	4030006880	S.CERAMIC C1608 JB 1H 472K-T-A
C228	4610001830	S.TRIMMER TZBX4N100BA110T00 10P
C229	4030009920	S.CERAMIC C1608 CH 1H 050B-T-A
C252	4030007150	S.CERAMIC C1608 CH 1H 151J-T-A
C253	4030006880	S.CERAMIC C1608 JB 1H 472K-T-A
C254	4030011340	S.CERAMIC C1608 CH 1H 471J-T-A
C255	4030006880	S.CERAMIC C1608 JB 1H 472K-T-A
C256	4030009510	S.CERAMIC C1608 CH 1H 010B-T-A
C257	4030006880	S.CERAMIC C1608 JB 1H 472K-T-A
C258	4610001830	S.TRIMMER TZBX4N100BA110T00 10P
C259	4030011770	S.CERAMIC C1608 CH 1H 060B-T-A
C272	4030007130	S.CERAMIC C1608 CH 1H 101J-T-A
C273	4030006880	S.CERAMIC C1608 JB 1H 472K-T-A
C274	4030011340	S.CERAMIC C1608 CH 1H 471J-T-A
C275	4030006880	S.CERAMIC C1608 JB 1H 472K-T-A
C276	4030009510	S.CERAMIC C1608 CH 1H 010B-T-A
C277	4030006880	S.CERAMIC C1608 JB 1H 472K-T-A
C278	4610001830	S.TRIMMER TZBX4N100BA110T00 10P
C279	4030007020	S.CERAMIC C1608 CH 1H 120J-T-A
C301	4030006880	S.CERAMIC C1608 JB 1H 472K-T-A
C302	4030007080	S.CERAMIC C1608 CH 1H 390J-T-A
C304	4030007080	S.CERAMIC C1608 CH 1H 390J-T-A
C305	4030006980	S.CERAMIC C1608 CH 1H 070D-T-A
C306	4030007080	S.CERAMIC C1608 CH 1H 390J-T-A
C307	4030007020	S.CERAMIC C1608 CH 1H 120J-T-A
C309	4030006880	S.CERAMIC C1608 JB 1H 472K-T-A
C310	4030006880	S.CERAMIC C1608 JB 1H 472K-T-A
C311	4030006880	S.CERAMIC C1608 JB 1H 472K-T-A
C320	4030007080	S.CERAMIC C1608 CH 1H 390J-T-A
C321	4030007120	S.CERAMIC C1608 CH 1H 820J-T-A
C322	4030006880	S.CERAMIC C1608 JB 1H 472K-T-A
C323	4030006880	S.CERAMIC C1608 JB 1H 472K-T-A
C324	4030006880	S.CERAMIC C1608 JB 1H 472K-T-A
C325	4030011810	S.CERAMIC C1608 JB 1A 224K-T-N
C326	4030011600	S.CERAMIC C1608 JB 1C 104KT-N
C344	4030006880	S.CERAMIC C1608 JB 1H 472K-T-A
C345	4030006880	S.CERAMIC C1608 JB 1H 472K-T-A
C350	4030006880	S.CERAMIC C1608 JB 1H 472K-T-A
C351	4030008560	S.CERAMIC C1608 CH 1H 300J-T-A
C352	4030009530	S.CERAMIC C1608 CH 1H 030B-T-A
C353	4030007070	S.CERAMIC C1608 CH 1H 330J-T-A
C354	4030009520	S.CERAMIC C1608 CH 1H 020B-T-A
C355	4030007010	S.CERAMIC C1608 CH 1H 100D-T-A
C356	4030007050	S.CERAMIC C1608 CH 1H 220J-T-A

[PLL UNIT]

REF NO.	ORDER NO.	DESCRIPTION
C357	4030006880	S.CERAMIC C1608 JB 1H 472K-T-A
C358	4030007100	S.CERAMIC C1608 CH 1H 560J-T-A
C359	4030011280	S.CERAMIC C1608 CH 1H 271J-T-A
C360	4030007100	S.CERAMIC C1608 CH 1H 560J-T-A
C361	4030006880	S.CERAMIC C1608 JB 1H 472K-T-A
C362	4030006880	S.CERAMIC C1608 JB 1H 472K-T-A
C363	4030006880	S.CERAMIC C1608 JB 1H 472K-T-A
C364	4030006880	S.CERAMIC C1608 JB 1H 472K-T-A
C365	4030011600	S.CERAMIC C1608 JB 1C 104KT-N
C380	4550006760	S.TANTALUM TEMSVB2 1A 336M-8R
C381	4030006880	S.CERAMIC C1608 JB 1H 472K-T-A
C382	4030007130	S.CERAMIC C1608 CH 1H 101J-T-A
C384	4030011600	S.CERAMIC C1608 JB 1C 104KT-N
C385	4550006080	S.TANTALUM TEMSVB2 1C 106M-8L
C386	4550005980	S.TANTALUM TEMSVA 1A 475M-8L
C389	4030011340	S.CERAMIC C1608 CH 1H 471J-T-A
C390	4550006080	S.TANTALUM TEMSVB2 1C 106M-8L
C391	4030011600	S.CERAMIC C1608 JB 1C 104KT-N
C394	4030006850	S.CERAMIC C1608 JB 1H 471K-T-A
C395	4030006900	S.CERAMIC C1608 JB 1E 103K-T-A
C396	4550006480	S.TANTALUM TEMSVA 1C 475M-8L
C397	4030006880	S.CERAMIC C1608 JB 1H 472K-T-A
C401	4550006080	S.TANTALUM TEMSVB2 1C 106M-8L
C402	4030011600	S.CERAMIC C1608 JB 1C 104KT-N
C403	4030011600	S.CERAMIC C1608 JB 1C 104KT-N
C404	4030011600	S.CERAMIC C1608 JB 1C 104KT-N
C405	4030011600	S.CERAMIC C1608 JB 1C 104KT-N
C406	4030011600	S.CERAMIC C1608 JB 1C 104KT-N
C407	4030011600	S.CERAMIC C1608 JB 1C 104KT-N
C408	4030011600	S.CERAMIC C1608 JB 1C 104KT-N
C409	4030011600	S.CERAMIC C1608 JB 1C 104KT-N
C410	4030011600	S.CERAMIC C1608 JB 1C 104KT-N
C411	4030011600	S.CERAMIC C1608 JB 1C 104KT-N
C412	4030011600	S.CERAMIC C1608 JB 1C 104KT-N
C413	4030011600	S.CERAMIC C1608 JB 1C 104KT-N
C414	4030011600	S.CERAMIC C1608 JB 1C 104KT-N
C415	4030011600	S.CERAMIC C1608 JB 1C 104KT-N
C416	4030011600	S.CERAMIC C1608 JB 1C 104KT-N
C417	4030011600	S.CERAMIC C1608 JB 1C 104KT-N
C418	4030011600	S.CERAMIC C1608 JB 1C 104KT-N
C419	4030006880	S.CERAMIC C1608 JB 1H 472K-T-A
C420	4030011600	S.CERAMIC C1608 JB 1C 104KT-N
C421	4550006250	S.TANTALUM TEMSVA 1A 106M-8L
C422	4030006880	S.CERAMIC C1608 JB 1H 472K-T-A
C423	4030006880	S.CERAMIC C1608 JB 1H 472K-T-A
C424	4030006880	S.CERAMIC C1608 JB 1H 472K-T-A
C425	4030006880	S.CERAMIC C1608 JB 1H 472K-T-A
C426	4030006880	S.CERAMIC C1608 JB 1H 472K-T-A
C427	4030006880	S.CERAMIC C1608 JB 1H 472K-T-A
C428	4030006880	S.CERAMIC C1608 JB 1H 472K-T-A
C431	4030012600	S.CERAMIC C2012 JB 1A 105M-T-A
C437	4030006880	S.CERAMIC C1608 JB 1H 471J-T-A
C438	4030006880	S.CERAMIC C1608 JB 1H 472K-T-A
C439	4030006880	S.CERAMIC C1608 JB 1H 472K-T-A
C447	4030006880	S.CERAMIC C1608 JB 1H 472K-T-A
C450	4030011600	S.CERAMIC C1608 JB 1C 104KT-N
C451	4030006880	S.CERAMIC C1608 JB 1H 472K-T-A
C452	4030007070	S.CERAMIC C1608 CH 1H 330J-T-A
C453	4030009910	S.CERAMIC C1608 CH 1H 040B-T-A
C454	4610001850	S.TRIMMER TZBX4R200BA110T00 20P
C455	4030016550	S.CERAMIC CM105 CH 151G 50AT
C456	4030016550	S.CERAMIC CM105 CH 151G 50AT
C457	4030016550	S.CERAMIC CM105 CH 151G 50AT
C458	4550006080	S.TANTALUM TEMSVB2 1C 106M-8L
C459	4030006880	S.CERAMIC C1608 JB 1H 472K-T-A
C460	4030006880	S.CERAMIC C1608 JB 1H 472K-T-A
C461	4030009920	S.CERAMIC C1608 CH 1H 050B-T-A
C462	4030011600	S.CERAMIC C1608 JB 1C 104KT-N
C463	4030006880	S.CERAMIC C1608 JB 1H 472K-T-A
C472	4030006990	S.CERAMIC C1608 CH 1H 080D-T-A
C473	4030007030	S.CERAMIC C1608 CH 1H 150J-T-A
C474	4030007060	S.CERAMIC C1608 CH 1H 270J-T-A
C481	4030006880	S.CERAMIC C1608 JB 1H 472K-T-A
C482	4550006080	S.TANTALUM TEMSVB2 1C 106M-8L
C483	4030006880	S.CERAMIC C1608 JB 1H 472K-T-A
C491	4030006850	S.CERAMIC C1608 JB 1H 471K-T-A
C492	4030007130	S.CERAMIC C1608 CH 1H 101J-T-A
C493	4030009580	S.CERAMIC C1608 JB 1H 681K-T-A
C494	4030007080	S.CERAMIC C1608 CH 1H 390J-T-A
C495	4030006850	S.CERAMIC C1608 JB 1H 471K-T-A
C501	4030006880	S.CERAMIC C1608 JB 1H 472K-T-A
C502	4030009990	S.CERAMIC C1608 CH 1H 200J-T-A

S.=Surface mount

[PLL UNIT]

REF NO.	ORDER NO.	DESCRIPTION
C503	4030006880	S.CERAMIC C1608 JB 1H 472K-T-A
C504	4030011340	S.CERAMIC C1608 CH 1H 471J-T-A
C505	4030006880	S.CERAMIC C1608 JB 1H 472K-T-A
C506	4030009510	S.CERAMIC C1608 CH 1H 010B-T-A
C507	4030006880	S.CERAMIC C1608 JB 1H 472K-T-A
C508	4610001830	S.TRIMMER TZBX4N100BA110T00 10P
C509	4030009350	S.CERAMIC C1608 CH 1H 3R5B-T-A
C522	4030007100	S.CERAMIC C1608 CH 1H 560J-T-A
C523	4030006880	S.CERAMIC C1608 JB 1H 472K-T-A
C524	4030011340	S.CERAMIC C1608 CH 1H 471J-T-A
C525	4030006880	S.CERAMIC C1608 JB 1H 472K-T-A
C526	4030009510	S.CERAMIC C1608 CH 1H 010B-T-A
C527	4030006880	S.CERAMIC C1608 JB 1H 472K-T-A
C528	4610001830	S.TRIMMER TZBX4N100BA110T00 10P
C529	4030009920	S.CERAMIC C1608 CH 1H 050B-T-A
C552	4030007150	S.CERAMIC C1608 CH 1H 151J-T-A
C553	4030006880	S.CERAMIC C1608 JB 1H 472K-T-A
C554	4030011340	S.CERAMIC C1608 CH 1H 471J-T-A
C555	4030006880	S.CERAMIC C1608 JB 1H 472K-T-A
C556	4030009510	S.CERAMIC C1608 CH 1H 010B-T-A
C557	4030006880	S.CERAMIC C1608 JB 1H 472K-T-A
C558	4610001830	S.TRIMMER TZBX4N100BA110T00 10P
C559	4030011770	S.CERAMIC C1608 CH 1H 060B-T-A
C572	4030007130	S.CERAMIC C1608 CH 1H 101J-T-A
C573	4030006880	S.CERAMIC C1608 JB 1H 472K-T-A
C574	4030011340	S.CERAMIC C1608 CH 1H 471J-T-A
C575	4030006880	S.CERAMIC C1608 JB 1H 472K-T-A
C576	4030009510	S.CERAMIC C1608 CH 1H 010B-T-A
C577	4030006880	S.CERAMIC C1608 JB 1H 472K-T-A
C578	4610001830	S.TRIMMER TZBX4N100BA110T00 10P
C579	4030007020	S.CERAMIC C1608 CH 1H 120J-T-A
C601	4030006880	S.CERAMIC C1608 JB 1H 472K-T-A
C602	4030007080	S.CERAMIC C1608 CH 1H 390J-T-A
C604	4030007080	S.CERAMIC C1608 CH 1H 390J-T-A
C605	4030006980	S.CERAMIC C1608 CH 1H 070D-T-A
C606	4030007080	S.CERAMIC C1608 CH 1H 390J-T-A
C607	4030007020	S.CERAMIC C1608 CH 1H 120J-T-A
C609	4030006880	S.CERAMIC C1608 JB 1H 472K-T-A
C610	4030006880	S.CERAMIC C1608 JB 1H 472K-T-A
C611	4030006880	S.CERAMIC C1608 JB 1H 472K-T-A
C620	4030007080	S.CERAMIC C1608 CH 1H 390J-T-A
C621	4030007120	S.CERAMIC C1608 CH 1H 820J-T-A
C622	4030006880	S.CERAMIC C1608 JB 1H 472K-T-A
C623	4030006880	S.CERAMIC C1608 JB 1H 472K-T-A
C624	4030006880	S.CERAMIC C1608 JB 1H 472K-T-A
C625	4030011810	S.CERAMIC C1608 JB 1A 224K-T-N
C626	4030011600	S.CERAMIC C1608 JB 1C 104KT-N
C644	4030006880	S.CERAMIC C1608 JB 1H 472K-T-A
C645	4030006880	S.CERAMIC C1608 JB 1H 472K-T-A
C650	4030006880	S.CERAMIC C1608 JB 1H 472K-T-A
C651	4030008560	S.CERAMIC C1608 CH 1H 300J-T-A
C652	4030009530	S.CERAMIC C1608 CH 1H 030B-T-A
C653	4030007070	S.CERAMIC C1608 CH 1H 330J-T-A
C654	4030009520	S.CERAMIC C1608 CH 1H 020B-T-A
C655	4030007010	S.CERAMIC C1608 CH 1H 100D-T-A
C656	4030007050	S.CERAMIC C1608 CH 1H 220J-T-A
C657	4030006880	S.CERAMIC C1608 JB 1H 472K-T-A
C658	4030007100	S.CERAMIC C1608 CH 1H 560J-T-A
C659	4030011280	S.CERAMIC C1608 CH 1H 271J-T-A
C660	4030007100	S.CERAMIC C1608 CH 1H 560J-T-A
C661	4030006880	S.CERAMIC C1608 JB 1H 472K-T-A
C662	4030006880	S.CERAMIC C1608 JB 1H 472K-T-A
C663	4030006880	S.CERAMIC C1608 JB 1H 472K-T-A
C664	4030006880	S.CERAMIC C1608 JB 1H 472K-T-A
C665	4030011600	S.CERAMIC C1608 JB 1C 104KT-N
C680	4550006760	S.TANTALUM TEMSVB2 1A 336M-8R
C681	4030006880	S.CERAMIC C1608 JB 1H 472K-T-A
C682	4030007130	S.CERAMIC C1608 CH 1H 101J-T-A
C684	4030011600	S.CERAMIC C1608 JB 1C 104KT-N
C685	4550006080	S.TANTALUM TEMSVB2 1C 106M-8L
C686	4550005980	S.TANTALUM TEMSVA 1A 475M-8L
C689	4030011340	S.CERAMIC C1608 CH 1H 471J-T-A
C690	4550006080	S.TANTALUM TEMSVB2 1C 106M-8L
C691	4030011600	S.CERAMIC C1608 JB 1C 104KT-N
C694	4030011340	S.CERAMIC C1608 CH 1H 471J-T-A
C695	4030006900	S.CERAMIC C1608 JB 1E 103K-T-A
C696	4550006480	S.TANTALUM TEMSVA 1C 475M-8L
C697	4030006880	S.CERAMIC C1608 JB 1H 472K-T-A
C701	4550006080	S.TANTALUM TEMSVB2 1C 106M-8L
C702	4030011600	S.CERAMIC C1608 JB 1C 104KT-N
C703	4030011600	S.CERAMIC C1608 JB 1C 104KT-N
C704	4030011600	S.CERAMIC C1608 JB 1C 104KT-N

[PLL UNIT]

REF NO.	ORDER NO.	DESCRIPTION
C705	4030011600	S.CERAMIC C1608 JB 1C 104KT-N
C706	4030011600	S.CERAMIC C1608 JB 1C 104KT-N
C707	4030011600	S.CERAMIC C1608 JB 1C 104KT-N
C708	4030006880	S.CERAMIC C1608 JB 1H 472K-T-A
C709	4030011340	S.CERAMIC C1608 CH 1H 471J-T-A
C710	4030007120	S.CERAMIC C1608 CH 1H 820J-T-A
C711	4030009580	S.CERAMIC C1608 JB 1H 681K-T-A
C712	4030007070	S.CERAMIC C1608 CH 1H 330J-T-A
C713	4030010040	S.CERAMIC C1608 JB 1H 561K-T-A
C714	4030011280	S.CERAMIC C1608 CH 1H 271J-T-A
C715	4030006860	S.CERAMIC C1608 JB 1H 102K-T-A
C716	4030011280	S.CERAMIC C1608 CH 1H 271J-T-A
C801	4550006080	S.TANTALUM TEMSVB2 1C 106M-8L
C802	4030011600	S.CERAMIC C1608 JB 1C 104KT-N
C803	4030011600	S.CERAMIC C1608 JB 1C 104KT-N
C804	4030011600	S.CERAMIC C1608 JB 1C 104KT-N
C805	4030011600	S.CERAMIC C1608 JB 1C 104KT-N
C806	4030011600	S.CERAMIC C1608 JB 1C 104KT-N
C807	4030011600	S.CERAMIC C1608 JB 1C 104KT-N
C808	4030006880	S.CERAMIC C1608 JB 1H 472K-T-A
C809	4030007030	S.CERAMIC C1608 CH 1H 150J-T-A
C810	4030006970	S.CERAMIC C1608 CH 1H 060D-T-A
C811	4030007060	S.CERAMIC C1608 CH 1H 270J-T-A
C812	4030009520	S.CERAMIC C1608 CH 1H 020B-T-A
C813	4030007040	S.CERAMIC C1608 CH 1H 180J-T-A
C814	4030007040	S.CERAMIC C1608 CH 1H 180J-T-A
C815	4030007090	S.CERAMIC C1608 CH 1H 470J-T-A
C816	4030007040	S.CERAMIC C1608 CH 1H 180J-T-A
C817	4030006880	S.CERAMIC C1608 JB 1H 472K-T-A
C818	4030006880	S.CERAMIC C1608 JB 1H 472K-T-A
C826	4030011280	S.CERAMIC C1608 CH 1H 271J-T-A
C827	4030011280	S.CERAMIC C1608 CH 1H 271J-T-A
C901	4030006880	S.CERAMIC C1608 JB 1H 472K-T-A
C902	4550006080	S.TANTALUM TEMSVB2 1C 106M-8L
C903	4030007130	S.CERAMIC C1608 CH 1H 101J-T-A
C905	4030009580	S.CERAMIC C1608 JB 1H 681K-T-A
C906	4030011280	S.CERAMIC C1608 CH 1H 271J-T-A
C907	4030011280	S.CERAMIC C1608 CH 1H 271J-T-A
C908	4030011600	S.CERAMIC C1608 JB 1C 104KT-N
C910	4030012600	S.CERAMIC C2012 JB 1A 105M-T-A
C911	4030011600	S.CERAMIC C1608 JB 1C 104KT-N
C912	4030010750	S.CERAMIC C1608 CH 1H 201J-T-A
C913	4030007170	S.CERAMIC C1608 CH 1H 221J-T-A
C914	4030007020	S.CERAMIC C1608 CH 1H 120J-T-A
C915	4030008880	S.CERAMIC C1608 JB 1C 223K-T-A
C916	4030007110	S.CERAMIC C1608 CH 1H 680J-T-A
C917	4030007020	S.CERAMIC C1608 CH 1H 120J-T-A
C918	4030007020	S.CERAMIC C1608 CH 1H 120J-T-A
C919	4030009910	S.CERAMIC C1608 CH 1H 040B-T-A
C920	4030006880	S.CERAMIC C1608 JB 1H 472K-T-A
C921	4030006880	S.CERAMIC C1608 JB 1H 472K-T-A
C922	4550006080	S.TANTALUM TEMSVB2 1C 106M-8L
C923	4030006880	S.CERAMIC C1608 JB 1H 472K-T-A
C924	4030006880	S.CERAMIC C1608 JB 1H 472K-T-A
C925	4030006880	S.CERAMIC C1608 JB 1H 472K-T-A
C926	4030007170	S.CERAMIC C1608 CH 1H 221J-T-A
C927	4030006860	S.CERAMIC C1608 JB 1H 102K-T-A
C928	4030007100	S.CERAMIC C1608 CH 1H 560J-T-A
C929	4030009910	S.CERAMIC C1608 CH 1H 040B-T-A
C930	4030007130	S.CERAMIC C1608 CH 1H 101J-T-A
C931	4030007020	S.CERAMIC C1608 CH 1H 120J-T-A
C932	4030007100	S.CERAMIC C1608 CH 1H 560J-T-A
C934	4030011600	S.CERAMIC C1608 JB 1C 104KT-N
C935	4030006880	S.CERAMIC C1608 JB 1H 472K-T-A
C936	4550006080	S.TANTALUM TEMSVB2 1C 106M-8L
J1	6510019980	S.CONNECTOR 52808-1690
J81	6510007900	CONNECTOR TBP-P01X-A1 (B1)
J351	6510007900	CONNECTOR TBP-P01X-A1 (B1)
J651	6510007900	CONNECTOR TBP-P01X-A1 (B1)
J701	6510007900	CONNECTOR TBP-P01X-A1 (B1)
J801	6510007900	CONNECTOR TBP-P01X-A1 (B1)
J851	6510007900	CONNECTOR TBP-P01X-A1 (B1)
J901	6510007900	CONNECTOR TBP-P01X-A1 (B1)
P81	6510003240	CONNECTOR TMP-P01X-A1
P351	6510003240	CONNECTOR TMP-P01X-A1
P651	6510003240	CONNECTOR TMP-P01X-A1
P701	6510003240	CONNECTOR TMP-P01X-A1
P801	6510003240	CONNECTOR TMP-P01X-A1

S.=Surface mount

[PLL UNIT]

REF NO.	ORDER NO.	DESCRIPTION	
P851	6510003240	CONNECTOR	TMP-P01X-A1
P901	6510003240	CONNECTOR	TMP-P01X-A1
W1	7030003860	S.JUMPER	ERJ3GE JPW V
W2	7030003860	S.JUMPER	ERJ3GE JPW V
W6	7030003860	S.JUMPER	ERJ3GE JPW V
W10	7030003860	S.JUMPER	ERJ3GE JPW V
W25	7030003860	S.JUMPER	ERJ3GE JPW V
W28	7030003860	S.JUMPER	ERJ3GE JPW V
W29	7030003860	S.JUMPER	ERJ3GE JPW V
W32	7030003860	S.JUMPER	ERJ3GE JPW V
W33	7030003860	S.JUMPER	ERJ3GE JPW V
W51	7030003860	S.JUMPER	ERJ3GE JPW V
W92	7030003860	S.JUMPER	ERJ3GE JPW V
W121	7030003860	S.JUMPER	ERJ3GE JPW V
W122	7030003860	S.JUMPER	ERJ3GE JPW V
W151	7030008240	S.JUMPER	ERJ12YJ0R00H
W155	7030003860	S.JUMPER	ERJ3GE JPW V
W181	7030003860	S.JUMPER	ERJ3GE JPW V
W201	7030003970	S.JUMPER	MCR18EZJH JPW (000)
W202	7030008240	S.JUMPER	ERJ12YJ0R00H
W221	7030000010	S.JUMPER	MCR10EZJH JPW (000)
W222	7030008240	S.JUMPER	ERJ12YJ0R00H
W251	7030000010	S.JUMPER	MCR10EZJH JPW (000)
W252	7030008240	S.JUMPER	ERJ12YJ0R00H
W392	7030003860	S.JUMPER	ERJ3GE JPW V
W422	7030003860	S.JUMPER	ERJ3GE JPW V
W452	7030008240	S.JUMPER	ERJ12YJ0R00H
W455	7030003860	S.JUMPER	ERJ3GE JPW V
W481	7030003860	S.JUMPER	ERJ3GE JPW V
W521	7030000010	S.JUMPER	MCR10EZJH JPW (000)
W522	7030008240	S.JUMPER	ERJ12YJ0R00H
W551	7030000010	S.JUMPER	MCR10EZJH JPW (000)
W552	7030008240	S.JUMPER	ERJ12YJ0R00H
W571	7030003970	S.JUMPER	MCR18EZJH JPW (000)
W572	7030008240	S.JUMPER	ERJ12YJ0R00H
W692	7030003860	S.JUMPER	ERJ3GE JPW V
W821	7030003860	S.JUMPER	ERJ3GE JPW V
W951	7030000010	S.JUMPER	MCR10EZJH JPW (000)
W952	7030000010	S.JUMPER	MCR10EZJH JPW (000)
W962	7030003860	S.JUMPER	ERJ3GE JPW V
W963	7030003860	S.JUMPER	ERJ3GE JPW V
W964	7030003860	S.JUMPER	ERJ3GE JPW V
W965	7030003860	S.JUMPER	ERJ3GE JPW V
W966	7030003860	S.JUMPER	ERJ3GE JPW V
EP1	0910051794	PCB	B 5241D
EP151	6910012350	S.BEAD	MMZ1608Y 102BT
EP321	6910012350	S.BEAD	MMZ1608Y 102BT
EP451	6910012350	S.BEAD	MMZ1608Y 102BT
EP621	6910012350	S.BEAD	MMZ1608Y 102BT

[FILTER UNIT]

REF NO.	ORDER NO.	DESCRIPTION	
L30	6110003570	COIL	LA-550
L31	6110003550	COIL	LA-547
L32	6200001830	S.COIL	NL 322522T-100J
L41	6200001830	S.COIL	NL 322522T-100J
L45	6140003560	COIL	LR-394
L46	6140001820	COIL	LR-218
L501	6140003440	COIL	LR-386
L502	6140003440	COIL	LR-386
C2	4010008260	CERAMIC	HM74TJ SL 151J 500V
C3	4010008200	CERAMIC	HM11TJ SL 331J 500V
C5	4030012480	S.CERAMIC	GRM42-6 CH 121J 500PT
C7	4010005360	CERAMIC	HM11SJ SL 301J 500V
C8	4010005360	CERAMIC	HM11SJ SL 301J 500V
C10	4010005360	CERAMIC	HM11SJ SL 301J 500V
C12	4030011730	S.CERAMIC	GRM42-6 CH 101J 500PT
C14	4010005360	CERAMIC	HM11SJ SL 301J 500V
C15	4010008300	CERAMIC	HM11TJ SL 391J 500V
C16	4010005860	CERAMIC	HM95SJ SL 201J 500V
C17	4010008270	CERAMIC	HM95TJ SL 181J 500V
C18	4030011730	S.CERAMIC	GRM42-6 CH 101J 500PT
C20	4010005360	CERAMIC	HM11SJ SL 301J 500V
C21	4010005360	CERAMIC	HM11SJ SL 301J 500V
C22	4030011180	S.CERAMIC	GRM42-6 CH 220J 500PT
C23	4010008200	CERAMIC	HM11TJ SL 331J 500V
C24	4010008200	CERAMIC	HM11TJ SL 331J 500V
C25	4010008200	CERAMIC	HM11TJ SL 331J 500V
C28	4030011730	S.CERAMIC	GRM42-6 CH 101J 500PT
C30	4030011170	S.CERAMIC	GRM42-6 CH 180J 500PT
C31	4030011730	S.CERAMIC	GRM42-6 CH 101J 500PT
C32	4030012480	S.CERAMIC	GRM42-6 CH 121J 500PT
C33	4030011170	S.CERAMIC	GRM42-6 CH 180J 500PT
C34	4030012480	S.CERAMIC	GRM42-6 CH 121J 500PT
C35	4030011230	S.CERAMIC	GRM42-6 CH 390J 500PT
C36	4030011730	S.CERAMIC	GRM42-6 CH 101J 500PT
C37	4030011190	S.CERAMIC	GRM42-6 CH 270J 500PT
C38	4030011730	S.CERAMIC	GRM42-6 CH 101J 500PT
C39	4030011190	S.CERAMIC	GRM42-6 CH 270J 500PT
C40	4030011550	S.CERAMIC	GRM42-6 CH 680J 500PT
C41	4030011090	S.CERAMIC	GRM42-6 CH 070D 500PT
C42	4030006880	S.CERAMIC	C1608 JB 1H 472K-T-A
C43	4030006880	S.CERAMIC	C1608 JB 1H 472K-T-A
C44	4030006880	S.CERAMIC	C1608 JB 1H 472K-T-A
C45	4030006880	S.CERAMIC	C1608 JB 1H 472K-T-A
C46	4030006880	S.CERAMIC	C1608 JB 1H 472K-T-A
C47	4030006880	S.CERAMIC	C1608 JB 1H 472K-T-A
C48	4030006880	S.CERAMIC	C1608 JB 1H 472K-T-A
C49	4030006880	S.CERAMIC	C1608 JB 1H 472K-T-A
C50	4030006880	S.CERAMIC	C1608 JB 1H 472K-T-A
C51	4030006880	S.CERAMIC	C1608 JB 1H 472K-T-A
C52	4030006880	S.CERAMIC	C1608 JB 1H 472K-T-A
C53	4030006880	S.CERAMIC	C1608 JB 1H 472K-T-A
C62	4030011730	S.CERAMIC	GRM42-6 CH 101J 500PT
C63	4030011240	S.CERAMIC	GRM42-6 CH 470J 500PT
C65	4030011730	S.CERAMIC	GRM42-6 CH 101J 500PT
C66	4010005360	CERAMIC	HM11SJ SL 301J 500V
C67	4010005360	CERAMIC	HM11SJ SL 301J 500V
C68	4010005360	CERAMIC	HM11SJ SL 301J 500V
C69	4010005360	CERAMIC	HM11SJ SL 301J 500V
C72	4010008280	CERAMIC	HM95TJ SL 221J 500V
C73	4010005390	CERAMIC	HM15SJ SL 621J 500V
C74	4010005390	CERAMIC	HM15SJ SL 621J 500V
C75	4010005390	CERAMIC	HM15SJ SL 621J 500V
C77	4030011210	S.CERAMIC	GRM42-6 CH 330J 500PT
C78	4030011240	S.CERAMIC	GRM42-6 CH 470J 500PT
C79	4030011240	S.CERAMIC	GRM42-6 CH 470J 500PT
C80	4030011240	S.CERAMIC	GRM42-6 CH 470J 500PT
C81	4030011240	S.CERAMIC	GRM42-6 CH 470J 500PT
C82	4030011230	S.CERAMIC	GRM42-6 CH 390J 500PT
C83	4030011080	S.CERAMIC	GRM42-6 CH 060D 500PT
C85	4030011160	S.CERAMIC	GRM42-6 CH 150J 500PT
C86	4030011180	S.CERAMIC	GRM42-6 CH 220J 500PT
C87	4030006880	S.CERAMIC	C1608 JB 1H 472K-T-A
C88	4030006880	S.CERAMIC	C1608 JB 1H 472K-T-A
C97	4010005390	CERAMIC	HM15SJ SL 621J 500V
C98	4010005390	CERAMIC	HM15SJ SL 621J 500V
C99	4010005390	CERAMIC	HM15SJ SL 621J 500V
C100	4010005390	CERAMIC	HM15SJ SL 621J 500V
C102	4030011730	S.CERAMIC	GRM42-6 CH 101J 500PT
C103	4030012480	S.CERAMIC	GRM42-6 CH 121J 500PT
C104	4030012480	S.CERAMIC	GRM42-6 CH 121J 500PT

[FILTER UNIT]

REF NO.	ORDER NO.	DESCRIPTION	
L1	6140002570	COIL	LR-294
L2	6140002580	COIL	LR-295
L3	6140001240	COIL	LR-149
L4	6140001130	COIL	LR-138
L5	6140001800	COIL	LR-216
L6	6140001800	COIL	LR-216
L8	6140002270	COIL	LR-240
L9	6110002920	COIL	LA-481
L10	6110002910	COIL	LA-480
L13	6200003260	S.COIL	NL 322522T-101J
L15	6200003260	S.COIL	NL 322522T-101J
L17	6200003260	S.COIL	NL 322522T-101J
L19	6200003260	S.COIL	NL 322522T-101J
L21	6200001830	S.COIL	NL 322522T-100J
L23	6200001830	S.COIL	NL 322522T-100J
L24	6140003450	COIL	LR-387
L25	6140003460	COIL	LR-388
L26	6140003460	COIL	LR-388
L28	6140002280	COIL	LR-241
L29	6110003540	COIL	LA-548

S.=Surface mount

[FILTER UNIT]

REF NO.	ORDER NO.	DESCRIPTION	
C136	4030006880	S.CERAMIC	C1608 JB 1H 472K-T-A
C137	4030006880	S.CERAMIC	C1608 JB 1H 472K-T-A
C141	4010008290	CERAMIC	HM95TJ SL 271J 500V
C142	4030011230	S.CERAMIC	GRM42-6 CH 390J 500PT
C143	4010008280	CERAMIC	HM95TJ SL 221J 500V
C144	4010008280	CERAMIC	HM95TJ SL 221J 500V
C145	4030014460	S.CERAMIC	GRM42-6 CH 820J 500PT
C146	4030014460	S.CERAMIC	GRM42-6 CH 820J 500PT
C151	4010008200	CERAMIC	HM11TJ SL 331J 500V
C152	4010005390	CERAMIC	HM15SJ SL 621J 500V
C153	4010008200	CERAMIC	HM11TJ SL 331J 500V
C155	4030011210	S.CERAMIC	GRM42-6 CH 330J 500PT
C156	4030011550	S.CERAMIC	GRM42-6 CH 680J 500PT
C157	4030011210	S.CERAMIC	GRM42-6 CH 330J 500PT
C158	4030011210	S.CERAMIC	GRM42-6 CH 330J 500PT
C501	4030005140	S.CERAMIC	C3216 JB 1E 104K-T-A
C502	4030005140	S.CERAMIC	C3216 JB 1E 104K-T-A
C503	4030004740	S.CERAMIC	C2012 JB 1H 472K-T-A
C504	4030004740	S.CERAMIC	C2012 JB 1H 472K-T-A
C507	4030005140	S.CERAMIC	C3216 JB 1E 104K-T-A
C508	4030004740	S.CERAMIC	C2012 JB 1H 472K-T-A
C513	4030005140	S.CERAMIC	C3216 JB 1E 104K-T-A
C514	4030005140	S.CERAMIC	C3216 JB 1E 104K-T-A
C515	4030004740	S.CERAMIC	C2012 JB 1H 472K-T-A
C516	4030004740	S.CERAMIC	C2012 JB 1H 472K-T-A
C521	4030004740	S.CERAMIC	C2012 JB 1H 472K-T-A
C522	4030004740	S.CERAMIC	C2012 JB 1H 472K-T-A
C523	4030005140	S.CERAMIC	C3216 JB 1E 104K-T-A
C524	4030005140	S.CERAMIC	C3216 JB 1E 104K-T-A
RL1	6330001510	RELAY	TB1-160
RL2	6330001510	RELAY	TB1-160
RL3	6330001510	RELAY	TB1-160
RL4	6330001510	RELAY	TB1-160
RL5	6330001510	RELAY	TB1-160
RL6	6330001510	RELAY	TB1-160
RL7	6330001510	RELAY	TB1-160
RL8	6330001510	RELAY	TB1-160
RL9	6330001510	RELAY	TB1-160
RL10	6330001510	RELAY	TB1-160
RL11	6330001510	RELAY	TB1-160
RL12	6330001510	RELAY	TB1-160
RL13	6330001330	RELAY	AG 201344
RL14	6330001330	RELAY	AG 201344
RL15	6330001510	RELAY	TB1-160
RL16	6330001510	RELAY	TB1-160
J1	6510007020	CONNECTOR	TMP-J01X-V6
J2	6510007020	CONNECTOR	TMP-J01X-V6
J3	6510019970	S.CONNECTOR	52808-1090
W1	7030003860	S.JUMPER	ERJ3GE JPW V
W2	7030003860	S.JUMPER	ERJ3GE JPW V
W3	7030003860	S.JUMPER	ERJ3GE JPW V
W4	7030003860	S.JUMPER	ERJ3GE JPW V
W5	7030003860	S.JUMPER	ERJ3GE JPW V
W6	7030003860	S.JUMPER	ERJ3GE JPW V
W7	7030003860	S.JUMPER	ERJ3GE JPW V
W8	7030003860	S.JUMPER	ERJ3GE JPW V
W9	8900009620	CABLE	OPC-931
W10	8900009630	CABLE	OPC-962
EP1	0910051803	PCB	B 5287C
EP501	6510018330	TERMINAL	F4053A
EP502	6510018330	TERMINAL	F4053A

[TUNER UNIT]

REF NO.	ORDER NO.	DESCRIPTION	
IC1	1120000970	IC	M54562P
IC2	1120000970	IC	M54562P
L1	2040000490	COIL	EXC-ELDR25C
L2	2040000490	COIL	EXC-ELDR25C
L3	6110003010	COIL	LA-488
L4	6110003030	COIL	LA-490
L5	6110003020	COIL	LA-489
L6	6110003030	COIL	LA-490
L7	6110003020	COIL	LA-489
L8	6110003030	COIL	LA-490
L9	6140003260	COIL	LR-363
L10	6140003260	COIL	LR-363
L11	6140002700	COIL	LR-307
L12	6140002700	COIL	LR-307
R17	7030003440	S.RESISTOR	ERJ3GEYJ 102 V (1 kΩ)
R18	7030003440	S.RESISTOR	ERJ3GEYJ 102 V (1 kΩ)
R19	7030003440	S.RESISTOR	ERJ3GEYJ 102 V (1 kΩ)
R20	7030003440	S.RESISTOR	ERJ3GEYJ 102 V (1 kΩ)
R21	7030003440	S.RESISTOR	ERJ3GEYJ 102 V (1 kΩ)
R22	7030003440	S.RESISTOR	ERJ3GEYJ 102 V (1 kΩ)
R23	7030003440	S.RESISTOR	ERJ3GEYJ 102 V (1 kΩ)
R24	7030003440	S.RESISTOR	ERJ3GEYJ 102 V (1 kΩ)
R25	7030003440	S.RESISTOR	ERJ3GEYJ 102 V (1 kΩ)
R26	7030003440	S.RESISTOR	ERJ3GEYJ 102 V (1 kΩ)
R27	7030003440	S.RESISTOR	ERJ3GEYJ 102 V (1 kΩ)
R28	7030003440	S.RESISTOR	ERJ3GEYJ 102 V (1 kΩ)
R29	7030003440	S.RESISTOR	ERJ3GEYJ 102 V (1 kΩ)
R30	7030003440	S.RESISTOR	ERJ3GEYJ 102 V (1 kΩ)
R31	7030003440	S.RESISTOR	ERJ3GEYJ 102 V (1 kΩ)
R32	7030003440	S.RESISTOR	ERJ3GEYJ 102 V (1 kΩ)
C1	4030006880	S.CERAMIC	C1608 JB 1H 472K-T-A
C2	4030006880	S.CERAMIC	C1608 JB 1H 472K-T-A
C3	4030006880	S.CERAMIC	C1608 JB 1H 472K-T-A
C4	4030006880	S.CERAMIC	C1608 JB 1H 472K-T-A
C5	4030006880	S.CERAMIC	C1608 JB 1H 472K-T-A
C6	4030006880	S.CERAMIC	C1608 JB 1H 472K-T-A
C7	4030006880	S.CERAMIC	C1608 JB 1H 472K-T-A
C8	4030006880	S.CERAMIC	C1608 JB 1H 472K-T-A
C9	4030006880	S.CERAMIC	C1608 JB 1H 472K-T-A
C10	4030006880	S.CERAMIC	C1608 JB 1H 472K-T-A
C11	4030006880	S.CERAMIC	C1608 JB 1H 472K-T-A
C12	4030006880	S.CERAMIC	C1608 JB 1H 472K-T-A
C13	4030006880	S.CERAMIC	C1608 JB 1H 472K-T-A
C14	4030006880	S.CERAMIC	C1608 JB 1H 472K-T-A
C15	4030006880	S.CERAMIC	C1608 JB 1H 472K-T-A
C16	4030006880	S.CERAMIC	C1608 JB 1H 472K-T-A
C17	4030006880	S.CERAMIC	C1608 JB 1H 472K-T-A
C18	4030006880	S.CERAMIC	C1608 JB 1H 472K-T-A
C23	4030006880	S.CERAMIC	C1608 JB 1H 472K-T-A
C24	4030006880	S.CERAMIC	C1608 JB 1H 472K-T-A
C25	4030006880	S.CERAMIC	C1608 JB 1H 472K-T-A
C26	4030006880	S.CERAMIC	C1608 JB 1H 472K-T-A
C27	4030006880	S.CERAMIC	C1608 JB 1H 472K-T-A
C28	4030006880	S.CERAMIC	C1608 JB 1H 472K-T-A
C29	4030006880	S.CERAMIC	C1608 JB 1H 472K-T-A
C30	4030006880	S.CERAMIC	C1608 JB 1H 472K-T-A
C31	4030006880	S.CERAMIC	C1608 JB 1H 472K-T-A
C32	4030006880	S.CERAMIC	C1608 JB 1H 472K-T-A
C33	4030006880	S.CERAMIC	C1608 JB 1H 472K-T-A
C34	4010005070	CERAMIC	DE0707 SL 390J 3KV
C35	4010005070	CERAMIC	DE0707 SL 390J 3KV
C36	4010004260	CERAMIC	DE0907 SL 820J 3KV
C37	4010004250	CERAMIC	DE1007 SL 101J 3KV
C38	4010004280	CERAMIC	DE1207 SL 151J 3KV
C39	4010004280	CERAMIC	DE1207 SL 151J 3KV
C40	4010004250	CERAMIC	DE1007 SL 101J 3KV
C41	4010004250	CERAMIC	DE1007 SL 101J 3KV
C42	4010004250	CERAMIC	DE1007 SL 101J 3KV
C43	4010004250	CERAMIC	DE1007 SL 101J 3KV
C44	4620000140	VARIABLE	UV35A 150P
C45	4620000140	VARIABLE	UV35A 150P
C46	4030006880	S.CERAMIC	C1608 JB 1H 472K-T-A
C47	4030006880	S.CERAMIC	C1608 JB 1H 472K-T-A
C48	4030006880	S.CERAMIC	C1608 JB 1H 472K-T-A
C49	4030006880	S.CERAMIC	C1608 JB 1H 472K-T-A
C50	4030006880	S.CERAMIC	C1608 JB 1H 472K-T-A

S.=Surface mount

[TUNER UNIT]

REF NO.	ORDER NO.	DESCRIPTION	
C51	4030006880	S.CERAMIC	C1608 JB 1H 472K-T-A
C52	4030006880	S.CERAMIC	C1608 JB 1H 472K-T-A
C53	4030006880	S.CERAMIC	C1608 JB 1H 472K-T-A
C54	4030006880	S.CERAMIC	C1608 JB 1H 472K-T-A
C55	4030006880	S.CERAMIC	C1608 JB 1H 472K-T-A
C56	4030006880	S.CERAMIC	C1608 JB 1H 472K-T-A
C57	4030006880	S.CERAMIC	C1608 JB 1H 472K-T-A
C58	4030006880	S.CERAMIC	C1608 JB 1H 472K-T-A
C59	4030006880	S.CERAMIC	C1608 JB 1H 472K-T-A
C60	4030006880	S.CERAMIC	C1608 JB 1H 472K-T-A
C61	4030006880	S.CERAMIC	C1608 JB 1H 472K-T-A
RL1	6330001110	RELAY	NY-12W-K
RL2	6330001110	RELAY	NY-12W-K
RL3	6330001110	RELAY	NY-12W-K
RL4	6330001110	RELAY	NY-12W-K
RL5	6330001110	RELAY	NY-12W-K
RL6	6330001110	RELAY	NY-12W-K
RL7	6330001110	RELAY	NY-12W-K
RL8	6330001110	RELAY	NY-12W-K
RL9	6330001110	RELAY	NY-12W-K
RL10	6330001110	RELAY	NY-12W-K
RL11	6330001110	RELAY	NY-12W-K
RL12	6330001110	RELAY	NY-12W-K
RL13	6330001110	RELAY	NY-12W-K
RL14	6330001110	RELAY	NY-12W-K
RL15	6330001110	RELAY	NY-12W-K
J1	6510003100	CONNECTOR	RT01T-1.3B
J2	6510003100	CONNECTOR	RT01T-1.3B
J3	6510007900	CONNECTOR	TBP-P01X-A1 (B1)
J4	6510007900	CONNECTOR	TBP-P01X-A1 (B1)
J5	6510019990	S.CONNECTOR	52808-2290
P3	6510003240	CONNECTOR	TMP-P01X-A1
P4	6510003240	CONNECTOR	TMP-P01X-A1
MF1	2710000460	MOTOR	MP28GA STEPPING MOTOR
MF2	2710000460	MOTOR	MP28GA STEPPING MOTOR
EP1	0910052331	PCB	B 5408A

[CTRL UNIT]

REF NO.	ORDER NO.	DESCRIPTION	
IC1	1110000960	S.IC	NJM4558M-T1
IC2	1120002250	S.IC	TC74ACT32F
IC3	1120002240	S.IC	TC74AC112F
IC4	1110000960	S.IC	NJM4558M-T1
IC5	1140004120	S.IC	M38022M2-138FP
IC6	1140003610	S.IC	X24C04S8-2.7T6
IC9	1110002690	S.IC	NJM2903M-T1
IC10	1130003920	S.IC	TC4S69F (TE85R)
IC11	1130007700	S.IC	BU4094BCF-T1
IC12	1160000130	S.IC	TD62783AF (TP1)
IC13	1180001070	S.IC	TA7805F (TE16L)
IC14	1120002300	S.IC	TC74AC04F
Q5	1560000870	S.FET	2SK515-T1B (X33)
Q12	1590000680	S.TRANSISTOR	DTC114EUA T106
Q13	1590001330	S.TRANSISTOR	DTA114EUA T106
Q14	1590000680	S.TRANSISTOR	DTC114EUA T106
Q15	1590001330	S.TRANSISTOR	DTA114EUA T106
Q16	1590000680	S.TRANSISTOR	DTC114EUA T106
Q17	1590001330	S.TRANSISTOR	DTA114EUA T106
Q21	1590000680	S.TRANSISTOR	DTC114EUA T106
Q22	1590001330	S.TRANSISTOR	DTA114EUA T106
Q23	1590000680	S.TRANSISTOR	DTC114EUA T106
Q24	1590001330	S.TRANSISTOR	DTA114EUA T106
Q25	1530003090	S.TRANSISTOR	2SC4213-B (TE85R)
Q26	1590000680	S.TRANSISTOR	DTC114EUA T106

[CTRL UNIT]

REF NO.	ORDER NO.	DESCRIPTION	
Q27	1590001330	S.TRANSISTOR	DTA114EUA T106
Q211	1590000680	S.TRANSISTOR	DTC114EUA T106
Q212	1590000680	S.TRANSISTOR	DTC114EUA T106
Q213	1590000680	S.TRANSISTOR	DTC114EUA T106
Q214	1590000680	S.TRANSISTOR	DTC114EUA T106
Q215	1590000680	S.TRANSISTOR	DTC114EUA T106
Q216	1590000680	S.TRANSISTOR	DTC114EUA T106
Q217	1590000680	S.TRANSISTOR	DTC114EUA T106
Q218	1590000680	S.TRANSISTOR	DTC114EUA T106
D1	1790000490	S.DIODE	HSM88AS-TR
D2	1790000490	S.DIODE	HSM88AS-TR
D3	1750000200	S.DIODE	1SS319 (TE85R)
D4	1750000120	S.DIODE	DWA010-TE
D5	1790000690	S.DIODE	HSM88ASR-TR
D6	1790000490	S.DIODE	HSM88AS-TR
D7	1790000490	S.DIODE	HSM88AS-TR
D8	1790000490	S.DIODE	HSM88AS-TR
D9	1790000490	S.DIODE	HSM88AS-TR
D10	1750000120	S.DIODE	DWA010-TE
D11	1730000410	S.ZENER	RD5.1M-T2B2
D12	1730000030	S.ZENER	RD5.6M-T2B2
D13	1710000780	S.DIODE	MA114 (TX)
D15	1790000490	S.DIODE	HSM88AS-TR
D16	1750000270	S.DIODE	1SS301 (TE85R)
D17	1750000270	S.DIODE	1SS301 (TE85R)
D18	1750000270	S.DIODE	1SS301 (TE85R)
D20	1750000270	S.DIODE	1SS301 (TE85R)
D22	1790000620	S.DIODE	MA77 (TX)
D211	1750000200	S.DIODE	1SS319 (TE85R)
D213	1750000200	S.DIODE	1SS319 (TE85R)
D215	1750000200	S.DIODE	1SS319 (TE85R)
D217	1750000200	S.DIODE	1SS319 (TE85R)
X1	6050009890	S.XTAL	CR-569 (6.144 MHz)
L1	6140003270	COIL	LR-364
L2	6200001830	S.COIL	NL 322522T-100J
L3	6200003260	S.COIL	NL 322522T-101J
L4	6140003270	COIL	LR-364
L5	6180001220	COIL	LAL 04NA 100K
L8	6140003270	COIL	LR-364
L9	6180000450	COIL	RFC L6 222K
L10	6200003260	S.COIL	NL 322522T-101J
L11	6200003260	S.COIL	NL 322522T-101J
L13	6180000990	COIL	LAL 04NA 101K
L22	6140003270	COIL	LR-364
L25	6200003260	S.COIL	NL 322522T-101J
L27	6110001630	COIL	LA-246
L28	6110001560	COIL	LA-236
L29	2040000490	COIL	EXC-ELDR25C
L30	2040000490	COIL	EXC-ELDR25C
L31	2040000490	COIL	EXC-ELDR25C
L32	2040000490	COIL	EXC-ELDR25C
L33	6200003260	S.COIL	NL 322522T-101J
L34	6200003260	S.COIL	NL 322522T-101J
L35	6200003950	S.COIL	HF50ACC 322513-T
L36	6200003950	S.COIL	HF50ACC 322513-T
R1	7030007130	S.RESISTOR	ERJ1WYJ150H (15 Ω)
R2	7030007130	S.RESISTOR	ERJ1WYJ150H (15 Ω)
R3	7030003560	S.RESISTOR	ERJ3GEYJ 103 V (10 kΩ)
R4	7030003560	S.RESISTOR	ERJ3GEYJ 103 V (10 kΩ)
R5	7030003720	S.RESISTOR	ERJ3GEYJ 224 V (220 kΩ)
R6	7030003720	S.RESISTOR	ERJ3GEYJ 224 V (220 kΩ)
R7	7030003720	S.RESISTOR	ERJ3GEYJ 224 V (220 kΩ)
R8	7030003720	S.RESISTOR	ERJ3GEYJ 224 V (220 kΩ)
R9	7030003800	S.RESISTOR	ERJ3GEYJ 105 V (1 MΩ)
R10	7030003790	S.RESISTOR	ERJ3GEYJ 824 V (820 kΩ)
R13	7030003440	S.RESISTOR	ERJ3GEYJ 102 V (1 kΩ)
R14	7030003440	S.RESISTOR	ERJ3GEYJ 102 V (1 kΩ)
R15	7030003320	S.RESISTOR	ERJ3GEYJ 101 V (100 Ω)
R16	7030006540	S.RESISTOR	ERJ1WYJ330H (33 Ω)
R17	7030003320	S.RESISTOR	ERJ3GEYJ 101 V (100 Ω)
R26	7030003280	S.RESISTOR	ERJ3GEYJ 470 V (47 Ω)
R27	7030003280	S.RESISTOR	ERJ3GEYJ 470 V (47 Ω)
R28	7030003500	S.RESISTOR	ERJ3GEYJ 332 V (3.3 kΩ)
R29	7030003480	S.RESISTOR	ERJ3GEYJ 222 V (2.2 kΩ)

S.=Surface mount

[CTRL UNIT]

REF NO.	ORDER NO.	DESCRIPTION	
R30	7030003360	S.RESISTOR	ERJ3GEYJ 221 V (220 Ω)
R31	7030003480	S.RESISTOR	ERJ3GEYJ 222 V (2.2 kΩ)
R32	7030003680	S.RESISTOR	ERJ3GEYJ 104 V (100 kΩ)
R33	7030003530	S.RESISTOR	ERJ3GEYJ 562 V (5.6 kΩ)
R34	7030003530	S.RESISTOR	ERJ3GEYJ 562 V (5.6 kΩ)
R35	7030003670	S.RESISTOR	ERJ3GEYJ 823 V (82 kΩ)
R36	7030003820	S.RESISTOR	ERJ3GEYJ 155 V (1.5 MΩ)
R37	7030003560	S.RESISTOR	ERJ3GEYJ 103 V (10 kΩ)
R38	7030003560	S.RESISTOR	ERJ3GEYJ 103 V (10 kΩ)
R39	7030003680	S.RESISTOR	ERJ3GEYJ 104 V (100 kΩ)
R40	7030003680	S.RESISTOR	ERJ3GEYJ 104 V (100 kΩ)
R41	7030008040	S.RESISTOR	ERJ1WYJ820H (82 Ω)
R42	7030003560	S.RESISTOR	ERJ3GEYJ 103 V (10 kΩ)
R43	7030003560	S.RESISTOR	ERJ3GEYJ 103 V (10 kΩ)
R44	7030003800	S.RESISTOR	ERJ3GEYJ 105 V (1 MΩ)
R45	7030003560	S.RESISTOR	ERJ3GEYJ 103 V (10 kΩ)
R46	7030003520	S.RESISTOR	ERJ3GEYJ 472 V (4.7 kΩ)
R47	7030003440	S.RESISTOR	ERJ3GEYJ 102 V (1 kΩ)
R48	7030003560	S.RESISTOR	ERJ3GEYJ 103 V (10 kΩ)
R49	7030003680	S.RESISTOR	ERJ3GEYJ 104 V (100 kΩ)
R50	7030003540	S.RESISTOR	ERJ3GEYJ 682 V (6.8 kΩ)
R51	7030003540	S.RESISTOR	ERJ3GEYJ 682 V (6.8 kΩ)
R52	7030003680	S.RESISTOR	ERJ3GEYJ 104 V (100 kΩ)
R53	7030003820	S.RESISTOR	ERJ3GEYJ 155 V (1.5 MΩ)
R54	7030003560	S.RESISTOR	ERJ3GEYJ 103 V (10 kΩ)
R55	7030003560	S.RESISTOR	ERJ3GEYJ 103 V (10 kΩ)
R56	7030003680	S.RESISTOR	ERJ3GEYJ 104 V (100 kΩ)
R57	7030003680	S.RESISTOR	ERJ3GEYJ 104 V (100 kΩ)
R58	7540000130	ABSORBER	2P-50A-301
R59	7030003560	S.RESISTOR	ERJ3GEYJ 103 V (10 kΩ)
R60	7030003560	S.RESISTOR	ERJ3GEYJ 103 V (10 kΩ)
R61	7030003680	S.RESISTOR	ERJ3GEYJ 104 V (100 kΩ)
R62	7030003680	S.RESISTOR	ERJ3GEYJ 104 V (100 kΩ)
R63	7030003680	S.RESISTOR	ERJ3GEYJ 104 V (100 kΩ)
R64	7030003680	S.RESISTOR	ERJ3GEYJ 104 V (100 kΩ)
R65	7030003440	S.RESISTOR	ERJ3GEYJ 102 V (1 kΩ)
R66	7030003650	S.RESISTOR	ERJ3GEYJ 563 V (56 kΩ)
R67	7030003440	S.RESISTOR	ERJ3GEYJ 102 V (1 kΩ)
R69	7030003320	S.RESISTOR	ERJ3GEYJ 101 V (100 Ω)
R71	7030003440	S.RESISTOR	ERJ3GEYJ 102 V (1 kΩ)
R76	7030003560	S.RESISTOR	ERJ3GEYJ 103 V (10 kΩ)
R83	7030007130	S.RESISTOR	ERJ1WYJ150H (15 Ω)
R84	7030003560	S.RESISTOR	ERJ3GEYJ 103 V (10 kΩ)
R86	7030003710	S.RESISTOR	ERJ3GEYJ 184 V (180 kΩ)
R87	7030003660	S.RESISTOR	ERJ3GEYJ 683 V (68 kΩ)
R88	7030003660	S.RESISTOR	ERJ3GEYJ 683 V (68 kΩ)
R89	7030003840	S.RESISTOR	ERJ3GEYJ 225 V (2.2 MΩ)
R90	7030003720	S.RESISTOR	ERJ3GEYJ 224 V (2.2 kΩ)
R92	7030003440	S.RESISTOR	ERJ3GEYJ 102 V (1 kΩ)
R93	7030003560	S.RESISTOR	ERJ3GEYJ 103 V (10 kΩ)
R98	7030003440	S.RESISTOR	ERJ3GEYJ 102 V (1 kΩ)
R99	7030003560	S.RESISTOR	ERJ3GEYJ 103 V (10 kΩ)
R100	7030003660	S.RESISTOR	ERJ3GEYJ 683 V (68 kΩ)
R101	7030003660	S.RESISTOR	ERJ3GEYJ 683 V (68 kΩ)
R102	7030003570	S.RESISTOR	ERJ3GEYJ 123 V (12 kΩ)
R103	7030003680	S.RESISTOR	ERJ3GEYJ 104 V (100 kΩ)
R105	7030003440	S.RESISTOR	ERJ3GEYJ 102 V (1 kΩ)
R106	7030003440	S.RESISTOR	ERJ3GEYJ 102 V (1 kΩ)
R107	7030003680	S.RESISTOR	ERJ3GEYJ 104 V (100 kΩ)
R108	7030003440	S.RESISTOR	ERJ3GEYJ 102 V (1 kΩ)
R109	7030003440	S.RESISTOR	ERJ3GEYJ 102 V (1 kΩ)
R110	7030003440	S.RESISTOR	ERJ3GEYJ 102 V (1 kΩ)
R111	7030003440	S.RESISTOR	ERJ3GEYJ 102 V (1 kΩ)
R112	7030003440	S.RESISTOR	ERJ3GEYJ 102 V (1 kΩ)
R113	7030003440	S.RESISTOR	ERJ3GEYJ 102 V (1 kΩ)
R114	7030003440	S.RESISTOR	ERJ3GEYJ 102 V (1 kΩ)
R115	7030003440	S.RESISTOR	ERJ3GEYJ 102 V (1 kΩ)
R116	7030003440	S.RESISTOR	ERJ3GEYJ 102 V (1 kΩ)
R117	7030003440	S.RESISTOR	ERJ3GEYJ 102 V (1 kΩ)
R118	7030003440	S.RESISTOR	ERJ3GEYJ 102 V (1 kΩ)
R119	7030003440	S.RESISTOR	ERJ3GEYJ 102 V (1 kΩ)
R120	7030003440	S.RESISTOR	ERJ3GEYJ 102 V (1 kΩ)
R121	7030003440	S.RESISTOR	ERJ3GEYJ 102 V (1 kΩ)
R122	7030003360	S.RESISTOR	ERJ3GEYJ 221 V (220 Ω)
R123	7030003360	S.RESISTOR	ERJ3GEYJ 221 V (220 Ω)
R124	7030003360	S.RESISTOR	ERJ3GEYJ 221 V (220 Ω)
R125	7030003360	S.RESISTOR	ERJ3GEYJ 221 V (220 Ω)
R126	7030003200	S.RESISTOR	ERJ3GEYJ 100 V (10 Ω)
R127	7030003200	S.RESISTOR	ERJ3GEYJ 100 V (10 Ω)
R128	7030003200	S.RESISTOR	ERJ3GEYJ 100 V (10 Ω)
R129	7030003200	S.RESISTOR	ERJ3GEYJ 100 V (10 Ω)
R130	7030003200	S.RESISTOR	ERJ3GEYJ 100 V (10 Ω)

[CTRL UNIT]

REF NO.	ORDER NO.	DESCRIPTION	
R131	7030003200	S.RESISTOR	ERJ3GEYJ 100 V (10 Ω)
R132	7030003200	S.RESISTOR	ERJ3GEYJ 100 V (10 Ω)
R133	7030003200	S.RESISTOR	ERJ3GEYJ 100 V (10 Ω)
R136	7030003560	S.RESISTOR	ERJ3GEYJ 103 V (10 kΩ)
R137	7030003280	S.RESISTOR	ERJ3GEYJ 470 V (47 Ω)
R138	7030003440	S.RESISTOR	ERJ3GEYJ 102 V (1 kΩ)
R139	7030003560	S.RESISTOR	ERJ3GEYJ 103 V (10 kΩ)
R140	7030003280	S.RESISTOR	ERJ3GEYJ 470 V (47 Ω)
R141	7030003440	S.RESISTOR	ERJ3GEYJ 102 V (1 kΩ)
R142	7030003280	S.RESISTOR	ERJ3GEYJ 470 V (47 Ω)
R143	7030003440	S.RESISTOR	ERJ3GEYJ 102 V (1 kΩ)
R144	7030003280	S.RESISTOR	ERJ3GEYJ 470 V (47 Ω)
R145	7030003440	S.RESISTOR	ERJ3GEYJ 102 V (1 kΩ)
R146	7030003280	S.RESISTOR	ERJ3GEYJ 470 V (47 Ω)
R147	7030003440	S.RESISTOR	ERJ3GEYJ 102 V (1 kΩ)
R148	7030003640	S.RESISTOR	ERJ3GEYJ 473 V (47 kΩ)
R149	7030003680	S.RESISTOR	ERJ3GEYJ 104 V (100 kΩ)
R150	7030003390	S.RESISTOR	ERJ3GEYJ 391 V (390 Ω)
R151	7030003430	S.RESISTOR	ERJ3GEYJ 821 V (820 Ω)
R152	7030003520	S.RESISTOR	ERJ3GEYJ 472 V (4.7 kΩ)
R153	7030003520	S.RESISTOR	ERJ3GEYJ 472 V (4.7 kΩ)
R154	7030003480	S.RESISTOR	ERJ3GEYJ 222 V (2.2 kΩ)
R155	7030003390	S.RESISTOR	ERJ3GEYJ 391 V (390 Ω)
R211	7030003380	S.RESISTOR	ERJ3GEYJ 331 V (330 Ω)
R212	7030003380	S.RESISTOR	ERJ3GEYJ 331 V (330 Ω)
R213	7030003380	S.RESISTOR	ERJ3GEYJ 331 V (330 Ω)
R214	7030003380	S.RESISTOR	ERJ3GEYJ 331 V (330 Ω)
R215	7030003380	S.RESISTOR	ERJ3GEYJ 331 V (330 Ω)
R216	7030003380	S.RESISTOR	ERJ3GEYJ 331 V (330 Ω)
R217	7030003380	S.RESISTOR	ERJ3GEYJ 331 V (330 Ω)
R218	7030003380	S.RESISTOR	ERJ3GEYJ 331 V (330 Ω)
C1	4010005530	CERAMIC	HM60SJ SL 020C 500V
C2	4030007110	S.CERAMIC	C1608 CH 1H 680J-T-A
C3	4610001260	S.TRIMMER	ECR-JA020 E12W
C4	4010005530	CERAMIC	HM60SJ SL 020C 500V
C5	4030011540	S.CERAMIC	C1608 CH 1H 750J-T-A
C6	4030006860	S.CERAMIC	C1608 JB 1H 102K-T-A
C7	4030006860	S.CERAMIC	C1608 JB 1H 102K-T-A
C8	4030006880	S.CERAMIC	C1608 JB 1H 472K-T-A
C9	4030006880	S.CERAMIC	C1608 JB 1H 472K-T-A
C10	4030006880	S.CERAMIC	C1608 JB 1H 472K-T-A
C11	4030006880	S.CERAMIC	C1608 JB 1H 472K-T-A
C12	4010005540	CERAMIC	HM60SJ SL 030C 500V
C13	4030007070	S.CERAMIC	C1608 CH 1H 330J-T-A
C14	4030007070	S.CERAMIC	C1608 CH 1H 330J-T-A
C15	4030007070	S.CERAMIC	C1608 CH 1H 330J-T-A
C16	4030006880	S.CERAMIC	C1608 JB 1H 472K-T-A
C17	4030007120	S.CERAMIC	C1608 CH 1H 820J-T-A
C20	4030006880	S.CERAMIC	C1608 JB 1H 472K-T-A
C21	4030006880	S.CERAMIC	C1608 JB 1H 472K-T-A
C22	4550003120	S.TANTALUM	TEMSVD2 1A 476M-12L
C23	4030006880	S.CERAMIC	C1608 JB 1H 472K-T-A
C24	4030007170	S.CERAMIC	C1608 CH 1H 221J-T-A
C25	4030007170	S.CERAMIC	C1608 CH 1H 221J-T-A
C26	4030006880	S.CERAMIC	C1608 JB 1H 472K-T-A
C27	4030006880	S.CERAMIC	C1608 JB 1H 472K-T-A
C30	4030007170	S.CERAMIC	C1608 CH 1H 221J-T-A
C31	4030011340	S.CERAMIC	C1608 CH 1H 471J-T-A
C32	4010005520	CERAMIC	HM60SJ SL 010C 500V
C33	4030007110	S.CERAMIC	C1608 CH 1H 680J-T-A
C34	4030007120	S.CERAMIC	C1608 CH 1H 820J-T-A
C35	4030006880	S.CERAMIC	C1608 JB 1H 472K-T-A
C36	4030006860	S.CERAMIC	C1608 JB 1H 102K-T-A
C37	4030006880	S.CERAMIC	C1608 JB 1H 472K-T-A
C38	4030006880	S.CERAMIC	C1608 JB 1H 472K-T-A
C39	4030006880	S.CERAMIC	C1608 JB 1H 472K-T-A
C40	4030006880	S.CERAMIC	C1608 JB 1H 472K-T-A
C43	4030007170	S.CERAMIC	C1608 CH 1H 221J-T-A
C44	4030011340	S.CERAMIC	C1608 CH 1H 471J-T-A
C45	4030011600	S.CERAMIC	C1608 JB 1C 104KT-N
C46	4030011600	S.CERAMIC	C1608 JB 1C 104KT-N
C47	4030009990	S.CERAMIC	C1608 CH 1H 200J-T-A
C48	4030009990	S.CERAMIC	C1608 CH 1H 200J-T-A
C49	4030006880	S.CERAMIC	C1608 JB 1H 472K-T-A
C51	4030006860	S.CERAMIC	C1608 JB 1H 102K-T-A
C52	4030006880	S.CERAMIC	C1608 JB 1H 472K-T-A
C53	4030006880	S.CERAMIC	C1608 JB 1H 472K-T-A
C54	4030006880	S.CERAMIC	C1608 JB 1H 472K-T-A
C55	4030006860	S.CERAMIC	C1608 JB 1H 102K-T-A
C56	4030006880	S.CERAMIC	C1608 JB 1H 472K-T-A

S.=Surface mount

[CTRL UNIT]

REF NO.	ORDER NO.	DESCRIPTION	
C57	4030006880	S.CERAMIC	C1608 JB 1H 472K-T-A
C58	4030006880	S.CERAMIC	C1608 JB 1H 472K-T-A
C59	4030006880	S.CERAMIC	C1608 JB 1H 472K-T-A
C60	4030006880	S.CERAMIC	C1608 JB 1H 472K-T-A
C62	4030006880	S.CERAMIC	C1608 JB 1H 472K-T-A
C63	4030007090	S.CERAMIC	C1608 CH 1H 470J-T-A
C64	4030007030	S.CERAMIC	C1608 CH 1H 150J-T-A
C65	4030007120	S.CERAMIC	C1608 CH 1H 820J-T-A
C66	4030007070	S.CERAMIC	C1608 CH 1H 330J-T-A
C69	4510004630	S.ELECTROLYTIC	ECEV1CA100SR
C70	4510004630	S.ELECTROLYTIC	ECEV1CA100SR
C71	4030006880	S.CERAMIC	C1608 JB 1H 472K-T-A
C72	4510006260	S.ELECTROLYTIC	ECEV1AA471UP
C73	4030006880	S.CERAMIC	C1608 JB 1H 472K-T-A
C74	4030006880	S.CERAMIC	C1608 JB 1H 472K-T-A
C75	4030006880	S.CERAMIC	C1608 JB 1H 472K-T-A
C76	4030006880	S.CERAMIC	C1608 JB 1H 472K-T-A
C77	4030006880	S.CERAMIC	C1608 JB 1H 472K-T-A
C78	4030006880	S.CERAMIC	C1608 JB 1H 472K-T-A
C79	4030006880	S.CERAMIC	C1608 JB 1H 472K-T-A
C80	4030006880	S.CERAMIC	C1608 JB 1H 472K-T-A
C81	4030006880	S.CERAMIC	C1608 JB 1H 472K-T-A
C82	4030006880	S.CERAMIC	C1608 JB 1H 472K-T-A
C83	4030006880	S.CERAMIC	C1608 JB 1H 472K-T-A
C84	4030006880	S.CERAMIC	C1608 JB 1H 472K-T-A
C85	4030006880	S.CERAMIC	C1608 JB 1H 472K-T-A
C86	4030006880	S.CERAMIC	C1608 JB 1H 472K-T-A
C87	4030006880	S.CERAMIC	C1608 JB 1H 472K-T-A
C88	4510004630	S.ELECTROLYTIC	ECEV1CA100SR
C89	4030006880	S.CERAMIC	C1608 JB 1H 472K-T-A
C90	4510004630	S.ELECTROLYTIC	ECEV1CA100SR
C91	4030006880	S.CERAMIC	C1608 JB 1H 472K-T-A
C92	4030006880	S.CERAMIC	C1608 JB 1H 472K-T-A
C93	4030006880	S.CERAMIC	C1608 JB 1H 472K-T-A
C94	4030006880	S.CERAMIC	C1608 JB 1H 472K-T-A
C95	4030006880	S.CERAMIC	C1608 JB 1H 472K-T-A
C96	4030006880	S.CERAMIC	C1608 JB 1H 472K-T-A
C97	4030006880	S.CERAMIC	C1608 JB 1H 472K-T-A
C98	4510006220	S.ELECTROLYTIC	ECEV1CA101UP
C100	4030007130	S.CERAMIC	C1608 CH 1H 101J-T-A
C101	4030006880	S.CERAMIC	C1608 JB 1H 472K-T-A
C102	4510004630	S.ELECTROLYTIC	ECEV1CA100SR
C105	4030011540	S.CERAMIC	C1608 CH 1H 750J-T-A
C107	4010005580	CERAMIC	HM60SJ SL 070D 500V
C108	4010005560	CERAMIC	HM60SJ SL 050C 500V
C109	4030011600	S.CERAMIC	C1608 JB 1C 104KT-N
C200	4030007090	S.CERAMIC	C1608 CH 1H 470J-T-A
C201	4030007090	S.CERAMIC	C1608 CH 1H 470J-T-A
C202	4030007090	S.CERAMIC	C1608 CH 1H 470J-T-A
C209	4030006900	S.CERAMIC	C1608 JB 1E 103K-T-A
C210	4030006900	S.CERAMIC	C1608 JB 1E 103K-T-A
C211	4510004440	S.ELECTROLYTIC	ECEV1HA010SR
C212	4510004440	S.ELECTROLYTIC	ECEV1HA010SR
C213	4510004440	S.ELECTROLYTIC	ECEV1HA010SR
C214	4510004440	S.ELECTROLYTIC	ECEV1HA010SR
C215	4510004440	S.ELECTROLYTIC	ECEV1HA010SR
C216	4510004440	S.ELECTROLYTIC	ECEV1HA010SR
C217	4510004440	S.ELECTROLYTIC	ECEV1HA010SR
C218	4510004440	S.ELECTROLYTIC	ECEV1HA010SR
C220	4030006880	S.CERAMIC	C1608 JB 1H 472K-T-A
C221	4030007090	S.CERAMIC	C1608 CH 1H 470J-T-A
C222	4030007090	S.CERAMIC	C1608 CH 1H 470J-T-A
C223	4030007090	S.CERAMIC	C1608 CH 1H 470J-T-A
C224	4030006880	S.CERAMIC	C1608 JB 1H 472K-T-A
C225	4030006880	S.CERAMIC	C1608 JB 1H 472K-T-A
C226	4030006880	S.CERAMIC	C1608 JB 1H 472K-T-A
C227	4030006880	S.CERAMIC	C1608 JB 1H 472K-T-A
RL1	6330001450	RELAY	FXE-12G
RL2	6330001450	RELAY	FXE-12G
RL3	6330000800	RELAY	G5A-237P DC12V
RL4	6330000470	RELAY	NR-HD (12V) AE5343
J1	6510007900	CONNECTOR	TBP-P01X-A1 (B1)
J2	6510007900	CONNECTOR	TBP-P01X-A1 (B1)
J3	6510017150	CONNECTOR	TMP-S01X-C1
J4	6510017150	CONNECTOR	TMP-S01X-C1
J7	6510019990	S.CONNECTOR	52808-2290
J8	6510019990	S.CONNECTOR	52808-2290
J10	6510003410	CONNECTOR	B05B-EH-S

[CTRL UNIT]

REF NO.	ORDER NO.	DESCRIPTION	
J11	6510003410	CONNECTOR	B05B-EH-S
J12	6910001040	CONNECTOR	IPS-1136
J13	6510019970	S.CONNECTOR	52808-1090
J14	6910001040	CONNECTOR	IPS-1136
P1	6510003240	CONNECTOR	TMP-P01X-A1
P2	6510003240	CONNECTOR	TMP-P01X-A1
W1	7120000490	JUMPER	ERD25T0
W2	7120000490	JUMPER	ERD25T0
W3	7120000490	JUMPER	ERD25T0
W4	7030003860	S.JUMPER	ERJ3GE JPW V
EP1	0910051822	PCB	B 5300B

[PA UNIT]

REF NO.	ORDER NO.	DESCRIPTION	
IC1	1180001070	S.IC	TA7805F (TE16L)
IC2	1110002020	IC	TA7805S
IC3	1180001980	IC	MC78T08CT
Q1	1530000790	TRANSISTOR	2SC1971
Q2	1530000800	TRANSISTOR	2SC1972
Q3	1530000800	TRANSISTOR	2SC1972
Q4	1530003740	TRANSISTOR	2SC5125
Q5	1530003740	TRANSISTOR	2SC5125
Q8	1540000500	TRANSISTOR	2SD1585K
Q9	1590001150	S.TRANSISTOR	UN9211 (TX)
Q10	1530002060	S.TRANSISTOR	2SC4081 T107 R
Q11	1530002060	S.TRANSISTOR	2SC4081 T107 R
Q12	1520000650	S.TRANSISTOR	2SB1201-S-TL
Q13	1520000650	S.TRANSISTOR	2SB1201-S-TL
D1	1790000710	VARISTOR	MA29B
D2	1790000710	VARISTOR	MA29B
D3	1790000710	VARISTOR	MA29B
D4	1790000700	DIODE	DSA3A1
D5	1790000700	DIODE	DSA3A1
D7	1160000140	S.DIODE	DAP222 TL
D8	1790000700	DIODE	DSA3A1
D9	1160000140	S.DIODE	DAP222 TL
D10	1710000970	DIODE	MA185
L1	6140003240	S.COIL	LR-361
L2	2040000490	COIL	EXC-ELDR25C
L3	2040000490	COIL	EXC-ELDR25C
L4	6140001180	COIL	LR-143
L5	2040000490	COIL	EXC-ELDR25C
L6	6140003510	COIL	LR-393
L7	6140000610	COIL	LR-83
L8	6140002030	COIL	LR-230
L9	2040000490	COIL	EXC-ELDR25C
L10	2040000490	COIL	EXC-ELDR25C
L12	2040000490	COIL	EXC-ELDR25C
L14	6140003230	S.COIL	LR-360
L21	6110001730	COIL	LA-262
L22	2040000490	COIL	EXC-ELDR25C
R1	7030003380	S.RESISTOR	ERJ3GEYJ 331 V (330 Ω)
R2	7030003230	S.RESISTOR	ERJ3GEYJ 180 V (18 Ω)
R3	7030003380	S.RESISTOR	ERJ3GEYJ 331 V (330 Ω)
R4	7030003360	S.RESISTOR	ERJ3GEYJ 221 V (220 Ω)
R5	7030003390	S.RESISTOR	ERJ3GEYJ 391 V (390 Ω)
R6	7030003360	S.RESISTOR	ERJ3GEYJ 221 V (220 Ω)
R7	7030006210	S.RESISTOR	ERJ12YJ4R7H (4.7 Ω)
R8	7030008230	S.RESISTOR	ERJ1WYJ1R0H (1 Ω)
R9	7030008230	S.RESISTOR	ERJ1WYJ1R0H (1 Ω)
R10	7030003420	S.RESISTOR	ERJ3GEYJ 681 V (680 Ω)
R11	7310003750	TRIMMER	EVN-2ACA00 B52 (501)

S.=Surface mount

[PA UNIT]

REF NO.	ORDER NO.	DESCRIPTION	
R12	7030003300	S.RESISTOR	ERJ3GEYJ 680 V (68 Ω)
R13	7030000220	S.RESISTOR	MCR10EZHZ 47 Ω (470)
R14	7030000220	S.RESISTOR	MCR10EZHZ 47 Ω (470)
R15	7030006180	S.RESISTOR	ERJ1WYJ101H (100 Ω)
R16	7030006180	S.RESISTOR	ERJ1WYJ101H (100 Ω)
R17	7030006130	S.RESISTOR	ERJ1WYJ100H (10 Ω)
R18	7310003240	TRIMMER	EVN-2ACA00 B23 (202)
R19	7030003400	S.RESISTOR	ERJ3GEYJ 471 V (470 Ω)
R20	7030006130	S.RESISTOR	ERJ1WYJ100H (10 Ω)
R21	7030006130	S.RESISTOR	ERJ1WYJ100H (10 Ω)
R23	7030006130	S.RESISTOR	ERJ1WYJ100H (10 Ω)
R24	7030006130	S.RESISTOR	ERJ1WYJ100H (10 Ω)
R26	7030006060	S.RESISTOR	ERJ12YJ100H (10 Ω)
R27	7030006060	S.RESISTOR	ERJ12YJ100H (10 Ω)
R28	7100000640	RESISTOR	5 SI 0.012 Ω (J)
R29	7030003440	S.RESISTOR	ERJ3GEYJ 102 V (1 kΩ)
R31	7030003440	S.RESISTOR	ERJ3GEYJ 102 V (1 kΩ)
R32	7030007630	S.RESISTOR	MCR100JZHJ 0.68 Ω (R68)
R33	7030007630	S.RESISTOR	MCR100JZHJ 0.68 Ω (R68)
R34	7030007630	S.RESISTOR	MCR100JZHJ 0.68 Ω (R68)
R35	7030007630	S.RESISTOR	MCR100JZHJ 0.68 Ω (R68)
R38	7030006120	S.RESISTOR	ERJ1WYJ4R7H (4.7 Ω)
R39	7030006120	S.RESISTOR	ERJ1WYJ4R7H (4.7 Ω)
R40	7030006120	S.RESISTOR	ERJ1WYJ4R7H (4.7 Ω)
R41	7030009570	S.RESISTOR	ERJ1WYJ5R6H (5.6 Ω)
R42	7030009570	S.RESISTOR	ERJ1WYJ5R6H (5.6 Ω)
R44	7070000681	RESISTOR	ERX3SJ 3R9 (3.9 Ω)
R45	7030005340	S.RESISTOR	RR0816P-332-D (3.3 kΩ)
R46	7030008070	S.RESISTOR	RR0816P-273-D (27 kΩ)
R47	7030005980	S.RESISTOR	RR0816P-333-D (33 kΩ)
R48	7030008060	S.RESISTOR	RR0816P-222-D (2.2 kΩ)
R49	7030003440	S.RESISTOR	ERJ3GEYJ 102 V (1 kΩ)
R50	7510000070	THERMISTOR	ERT-D2FHL 503S
R51	7030006140	S.RESISTOR	ERJ1WYJ560H (56 Ω)
R52	7030006060	S.RESISTOR	ERJ12YJ100H (10 Ω)
R53	7030003440	S.RESISTOR	ERJ3GEYJ 102 V (1 kΩ)
R54	7030003440	S.RESISTOR	ERJ3GEYJ 102 V (1 kΩ)
R55	7030003560	S.RESISTOR	ERJ3GEYJ 103 V (10 kΩ)
R56	7030003560	S.RESISTOR	ERJ3GEYJ 103 V (10 kΩ)
R57	7030006270	S.RESISTOR	ERJ12YJ221H (220 Ω)
R58	7030003360	S.RESISTOR	ERJ3GEYJ 221 V (220 Ω)
C1	4030011600	S.CERAMIC	C1608 JB 1C 104KT-N
C2	4030006860	S.CERAMIC	C1608 JB 1H 102K-T-A
C3	4030011600	S.CERAMIC	C1608 JB 1C 104KT-N
C4	4030006860	S.CERAMIC	C1608 JB 1H 102K-T-A
C5	4030011600	S.CERAMIC	C1608 JB 1C 104KT-N
C6	4030006860	S.CERAMIC	C1608 JB 1H 102K-T-A
C7	4030006880	S.CERAMIC	C1608 JB 1H 472K-T-A
C8	4510004640	S.ELECTROLYTIC	ECEV1CA470SP
C9	4030011600	S.CERAMIC	C1608 JB 1C 104KT-N
C10	4030005010	S.CERAMIC	C2012 CH 1H 151J-T-A
C11	4030012490	S.CERAMIC	GRM42-6 SL 472J 100PT
C12	4030012490	S.CERAMIC	GRM42-6 SL 472J 100PT
C14	4030011600	S.CERAMIC	C1608 JB 1C 104KT-N
C15	4030011600	S.CERAMIC	C1608 JB 1C 104KT-N
C16	4510004630	S.ELECTROLYTIC	ECEV1CA100SR
C17	4030008920	S.CERAMIC	C1608 JB 1C 473K-T-A
C18	4030008920	S.CERAMIC	C1608 JB 1C 473K-T-A
C20	4030011600	S.CERAMIC	C1608 JB 1C 104KT-N
C21	4030012620	S.CERAMIC	GRM44-1 CH 102J 500PT
C22	4030012620	S.CERAMIC	GRM44-1 CH 102J 500PT
C23	4030012620	S.CERAMIC	GRM44-1 CH 102J 500PT
C24	4030012620	S.CERAMIC	GRM44-1 CH 102J 500PT
C25	4030011740	S.CERAMIC	GRM42-2 CH 201J 500PT
C27	4030008920	S.CERAMIC	C1608 JB 1C 473K-T-A
C30	4030004760	S.CERAMIC	C2012 JF 1E 104Z-T-A
C33	4030006880	S.CERAMIC	C1608 JB 1H 472K-T-A
C34	4030006880	S.CERAMIC	C1608 JB 1H 472K-T-A
C35	4030005110	S.CERAMIC	C2012 JB 1E 473K-T-A
C36	4510004600	ELECTROLYTIC	16 MV 1000 HC
C37	4030011600	S.CERAMIC	C1608 JB 1C 104KT-N
C39	4510004600	ELECTROLYTIC	16 MV 1000 HC
C40	4510004600	ELECTROLYTIC	16 MV 1000 HC
C41	4030006860	S.CERAMIC	C1608 JB 1H 102K-T-A
C42	4030011600	S.CERAMIC	C1608 JB 1C 104KT-N
C57	4030011740	S.CERAMIC	GRM42-2 CH 201J 500PT
C58	4030016740	S.CERAMIC	GRH111 CH 102J 50PT
C59	4030011740	S.CERAMIC	GRM42-2 CH 201J 500PT
C60	4030011740	S.CERAMIC	GRM42-2 CH 201J 500PT
C61	4030012620	S.CERAMIC	GRM44-1 CH 102J 500PT

[PA UNIT]

REF NO.	ORDER NO.	DESCRIPTION	
C62	4030012620	S.CERAMIC	GRM44-1 CH 102J 500PT
C71	4030011600	S.CERAMIC	C1608 JB 1C 104KT-N
C72	4030011600	S.CERAMIC	C1608 JB 1C 104KT-N
C73	4510004630	S.ELECTROLYTIC	ECEV1CA100SR
C74	4510004630	S.ELECTROLYTIC	ECEV1CA100SR
C75	4030011600	S.CERAMIC	C1608 JB 1C 104KT-N
C76	4030011600	S.CERAMIC	C1608 JB 1C 104KT-N
C77	4510006220	S.ELECTROLYTIC	ECEV1CA101UP
C78	4510006220	S.ELECTROLYTIC	ECEV1CA101UP
C79	4030011600	S.CERAMIC	C1608 JB 1C 104KT-N
C80	4030011600	S.CERAMIC	C1608 JB 1C 104KT-N
C81	4510004630	S.ELECTROLYTIC	ECEV1CA100SR
C82	4510004630	S.ELECTROLYTIC	ECEV1CA100SR
C89	4030011600	S.CERAMIC	C1608 JB 1C 104KT-N
C93	4030011600	S.CERAMIC	C1608 JB 1C 104KT-N
C94	4030006880	S.CERAMIC	C1608 JB 1H 472K-T-A
C95	4030006880	S.CERAMIC	C1608 JB 1H 472K-T-A
C96	4510005000	ELECTROLYTIC	16 MV 220 HC
C97	4030006880	S.CERAMIC	C1608 JB 1H 472K-T-A
C99	4510004590	ELECTROLYTIC	16 MV 470 HC
C100	4030006880	S.CERAMIC	C1608 JB 1H 472K-T-A
C101	4030006880	S.CERAMIC	C1608 JB 1H 472K-T-A
C102	4030006880	S.CERAMIC	C1608 JB 1H 472K-T-A
C103	4510004630	S.ELECTROLYTIC	ECEV1CA100SR
C105	4510006220	S.ELECTROLYTIC	ECEV1CA101UP
C107	4030006880	S.CERAMIC	C1608 JB 1H 472K-T-A
C108	4030006880	S.CERAMIC	C1608 JB 1H 472K-T-A
C109	4030006880	S.CERAMIC	C1608 JB 1H 472K-T-A
C110	4030006880	S.CERAMIC	C1608 JB 1H 472K-T-A
C111	4030006880	S.CERAMIC	C1608 JB 1H 472K-T-A
C112	4030006880	S.CERAMIC	C1608 JB 1H 472K-T-A
C113	4030006880	S.CERAMIC	C1608 JB 1H 472K-T-A
C114	4030006880	S.CERAMIC	C1608 JB 1H 472K-T-A
C115	4030006880	S.CERAMIC	C1608 JB 1H 472K-T-A
C116	4030011730	S.CERAMIC	GRM42-6 CH 101J 500PT
C117	4030007090	S.CERAMIC	C1608 CH 1H 470J-T-A
C118	4030012480	S.CERAMIC	GRM42-6 CH 121J 500PT
C119	4030012480	S.CERAMIC	GRM42-6 CH 121J 500PT
C120	4010005830	CERAMIC	HM74SJ SL 151J 500V
C121	4510004640	S.ELECTROLYTIC	ECEV1CA470SP
C122	4030004910	S.CERAMIC	C2012 CH 1H 220J-T-A
C123	4030011170	S.CERAMIC	GRM42-6 CH 180J 500PT
RL1	6330001160	RELAY	AJV5341 (JV1AP-DC12V)
J1	6510007900	CONNECTOR	TBP-P01X-A1 (B1)
J2	6510007900	CONNECTOR	TBP-P01X-A1 (B1)
J3	6510020000	S.CONNECTOR	52808-3090
J10	6510003080	CONNECTOR	RT01T-1.0B
J11	6510018960	S.CONNECTOR	B2B-PH-SM3-TB
P1	6510003240	CONNECTOR	TMP-P01X-A1
P2	6510003240	CONNECTOR	TMP-P01X-A1
F1	5210000060	FUSE	FGB 5A
F2	5220000230	HOLDER	S-N5054 #01
F3	5220000230	HOLDER	S-N5054 #01
EP1	0910051813	PCB	B 5294C
EP2	6910000610	BEAD	FSOH050RN01
EP3	6910000610	BEAD	FSOH050RN01
EP4	6510018330	TERMINAL	F4053A
EP5	6510018330	TERMINAL	F4053A
EP8	9021002002	TUBE	IRRAX 1.5 (d) L=10 mm
EP9	9021002002	TUBE	IRRAX 1.5 (d) L=10 mm
EP10	9006400002	TUBE	IRRAX 1.5 (d) L=21 mm
EP11	9034701901	TUBE	IRRAX 0.7 (d) L=20 mm
EP12	0910052241	PCB	B 5447A
EP13	0910052341	PCB	B 5449A
EP14	0910052351	PCB	B 5450A

S.=Surface mount

SECTION 6 MECHANICAL PARTS

[FRONT UNIT]

REF. NO.	ORDER NO.	DESCRIPTION	QTY.
DS1	5080000450	SLU2LC1EX5B-TH	1
ME1	5510000480	Meter ME-40	1
EP1	6910011090	Sensor unit RMS20-250-201-P	1
EP2	6450001230	Plate HLJ0999-01-480	1
EP3	6450001230	Plate HLJ0999-01-480	1
EP4	6910012500	Unit board TFD50W40	1
MP1	8210016720	1876 front panel (B)-1	1
MP2	8010016722	1876 sub chassis-2	1
MP3	8930041380	1876 window plate	1
MP4	8930041270	1876 power button	1
MP5	8930050370	1876 4-key (A)	1
MP6	8930050310	1876 key board (A)	1
MP7	8930050290	1876 7-key (A)	1
MP8	8930050380	1876 5-key (A)	1
MP9	8930050300	1876 10-key (A)	1
MP10	8930041280	1876 2-key	1
MP11	8610010720	Knob N273	3
MP12	8610010260	Knob N252	3
MP13	8610010270	Knob N253	1
MP14	8610010630	Knob N268 base	1
MP15	8930041390	1876 D-rubber	1
MP16	8930041230	1876 A-lens	1
MP17	8930041240	1876 B-lens	4
MP18	8930041250	1876 C-lens	2
MP19	8310046860	2178 name plate	1
MP20	8930041060	1876 brake plate	1
MP21	8930027470	1296 brake pad	1
MP23	8810008660	Screw PH BT M3 × 8 NI-ZU	6
MP24	8810008760	Screw PH BT M2 × 8 NI-ZU	1
MP25	8810008760	Screw PH BT M2 × 8 NI-ZU	2
MP26	8810009560	Screw PH BT M2 × 6 ZK	6
MP27	8810009560	Screw PH BT M2 × 6 ZK	6
MP29	8820000770	1296 screw	1
MP30	8810009390	Screw PH BT M3 × 18 NI-ZU	1
MP36	8610007420	Knob spring No.6601	4
MP37	8610007420	Knob spring No.6601	1
MP40	8810008760	Screw PH BT M2 × 8 NI-ZU	2
MP41	8810008760	Screw PH BT M2 × 8 NI-ZU	2
MP46	8930037111	1691 brake sheet-1	1
MP47	8930032340	1424 N-spring	1
MP48	8610010040	Knob N239 finger rest	1
MP49	8810008200	Screw PH BT M2.6 × 6 NI-ZU	1
MP50	8810007300	Screw PH B0 M2.6 × 14 ZK	2
MP51	8610010740	Knob N-273 (A)	1
MP52	8610010730	Knob N-252 (A)	1
MP53	8850001250	Flat washer M2.6 (2.6 × 5 × 0.5)	1
MP54	8930051520	Sheet No.631S #25 L=230	1

[DISPLAY BOARD]

REF. NO.	ORDER NO.	DESCRIPTION	QTY.
R701	7210002890	Variable register RV-308	1
R702	7210002890	Variable register RV-308	1
MP1	8510012630	2178 shield case	1
MP3	8510010760	1876 DDS case	1
MP4	8510010770	1876 DDS cover	1
MP5	8510001080	Shield case (A)	1
MP6	8510001101	Shield cover (A)-1	1
MP7	8210013980	1876 reflector	1

[PBT BOARD]

REF. NO.	ORDER NO.	DESCRIPTION	QTY.
R1	7210002970	Variable register RV-314	1
S1	2250000410	Encoder TP90D96E20-30F-2178-1	1

[DSP BOARD]

REF. NO.	ORDER NO.	DESCRIPTION	QTY.
MP1	8510012571	2178 DSP case-1	1

[RIT BOARD]

REF. NO.	ORDER NO.	DESCRIPTION	QTY.
S1	2250000340	Encoder EVQ-VCJF0324B	1

[PHONE BOARD]

REF. NO.	ORDER NO.	DESCRIPTION	QTY.
J2	6450001980	Connector HLJ5815-01-030	1

[KEY BOARD]

REF. NO.	ORDER NO.	DESCRIPTION	QTY.
J2	6450001790	Connector HLJ70000-01-3010	1

[MIC BOARD]

REF. NO.	ORDER NO.	DESCRIPTION	QTY.
J1	6510000190	Connector FM214-8SS (P)	1

[CHASSIS PARTS]

REF. NO.	ORDER NO.	DESCRIPTION	QTY.
J5	6510000370	Connector MR-DS	1
J6	6510000370	Connector MR-DS	1
SP1	2510000760	SM-77KY0208	1
MF1	2710000630	Fan FBA08T12HC	1
EP1	6910000340	Insulation sheet P101 (KD)	1
EP2	6910000310	Insulation washer B312D	1
MP1	8410002322	1876 heatsink (A)-2	1
MP2	8110005931	1876 T-cover-1	1
MP3	8110005922	1876 L-cover-2	1
MP4	8510012530	2178 A-plate	1
MP5	8510010730	1876 B-plate	1
MP6	8510010740	1876 C-plate	1
MP7	8510010751	1876 D-plate-1	1
MP8	8930041350	1876 main stand	2
MP9	8930041340	1876 sub stand	2
MP11	8930002910	Rubber foot (B)	2
MP12	8930002910	Rubber foot (B)	2
MP13	8930029730	1413 fan holder	1
MP15	8930037001	1691 earth plate-1	2
MP16	8930018520	TR crip (A)	1
MP17	8930035240	1546 TR-B crip	1
MP19	8930036070	1528 SP net	1
MP20	8810005770	Screw BiH M3 × 8 ZK	11
MP21	8810005770	Screw BiH M3 × 8 ZK	6
MP22	8810008660	Screw PH BT M3 × 8 NI-ZU	4
MP23	8810008660	Screw PH BT M3 × 8 NI-ZU	11
MP24	8810008660	Screw PH BT M3 × 8 NI-ZU	3
MP25	8810008660	Screw PH BT M3 × 8 NI-ZU	6
MP26	8810008660	Screw PH BT M3 × 8 NI-ZU	2
MP27	8810008660	Screw PH BT M3 × 8 NI-ZU	2

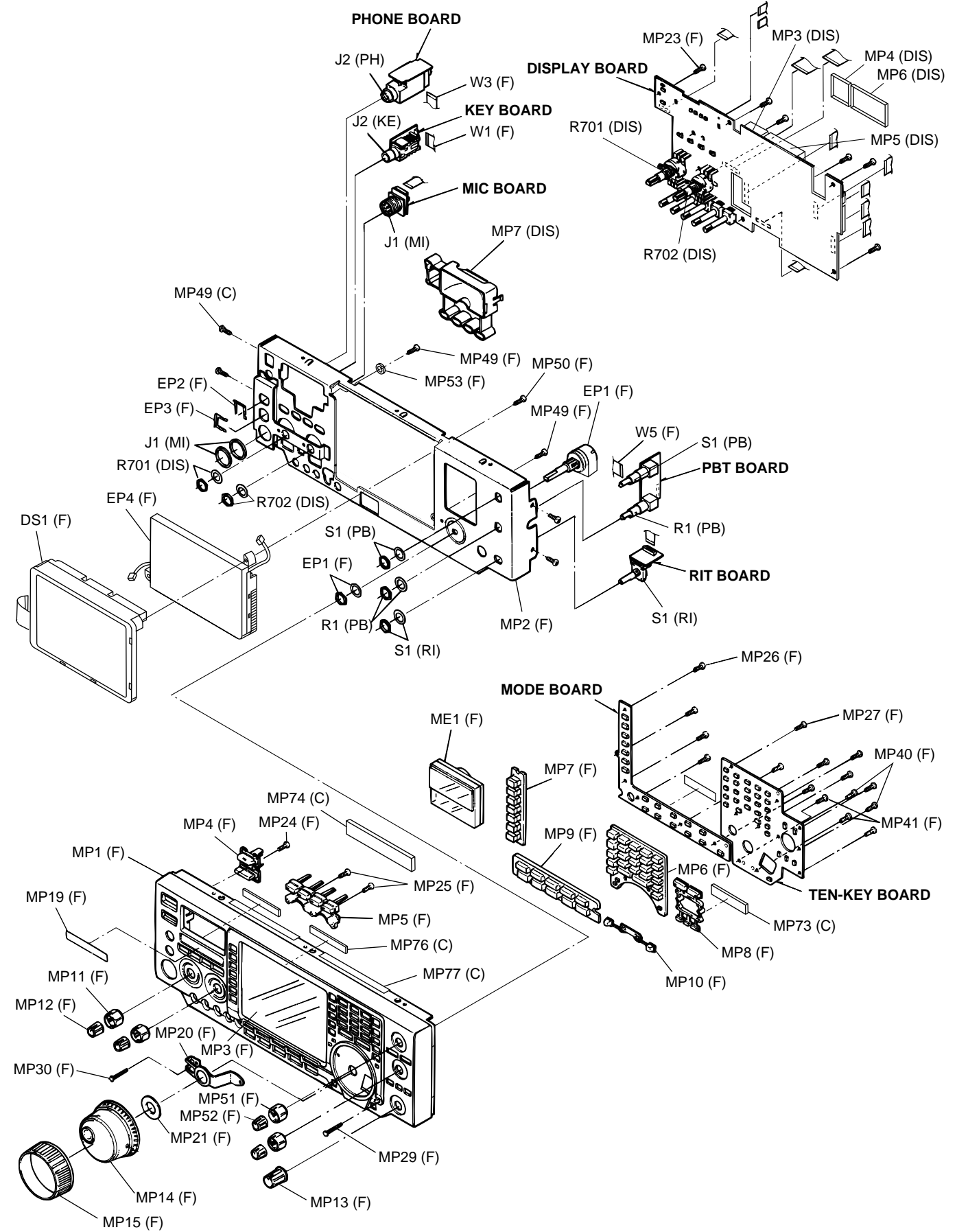
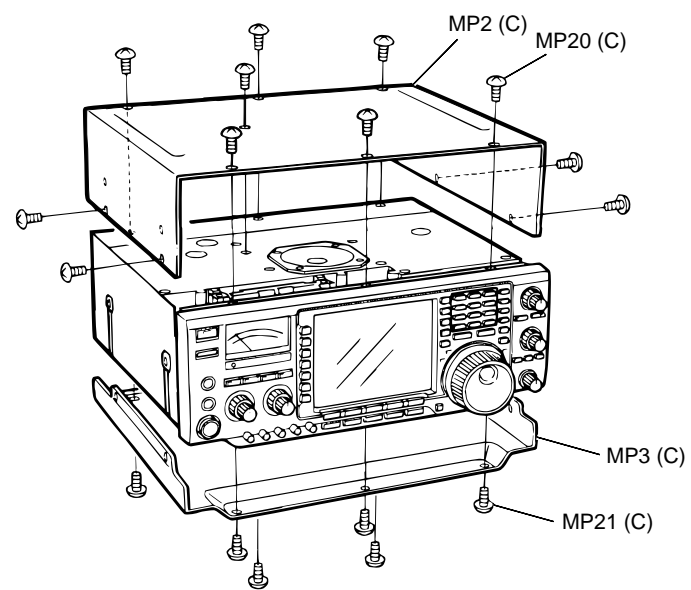
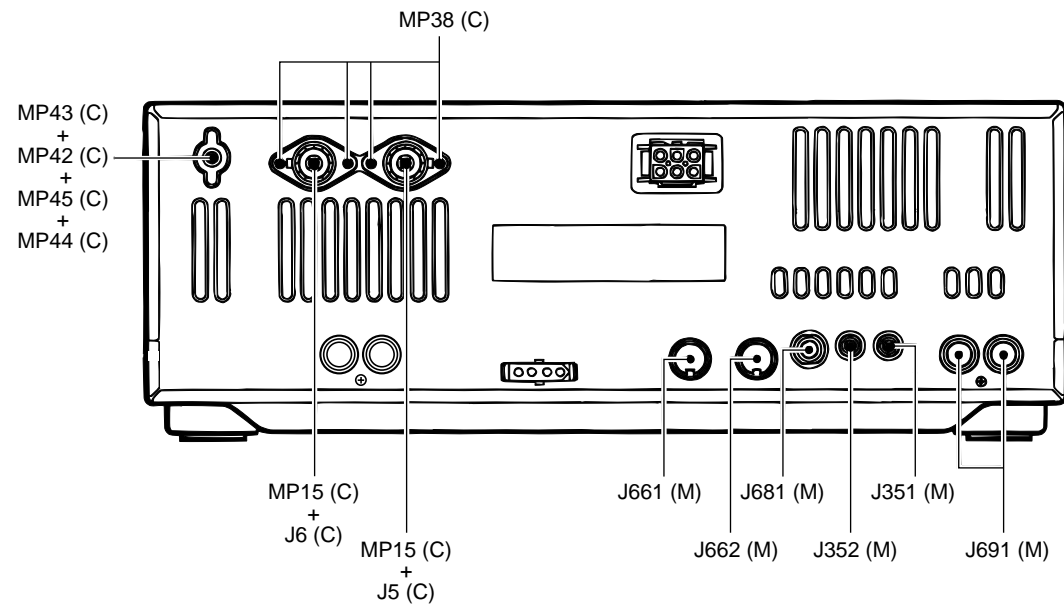
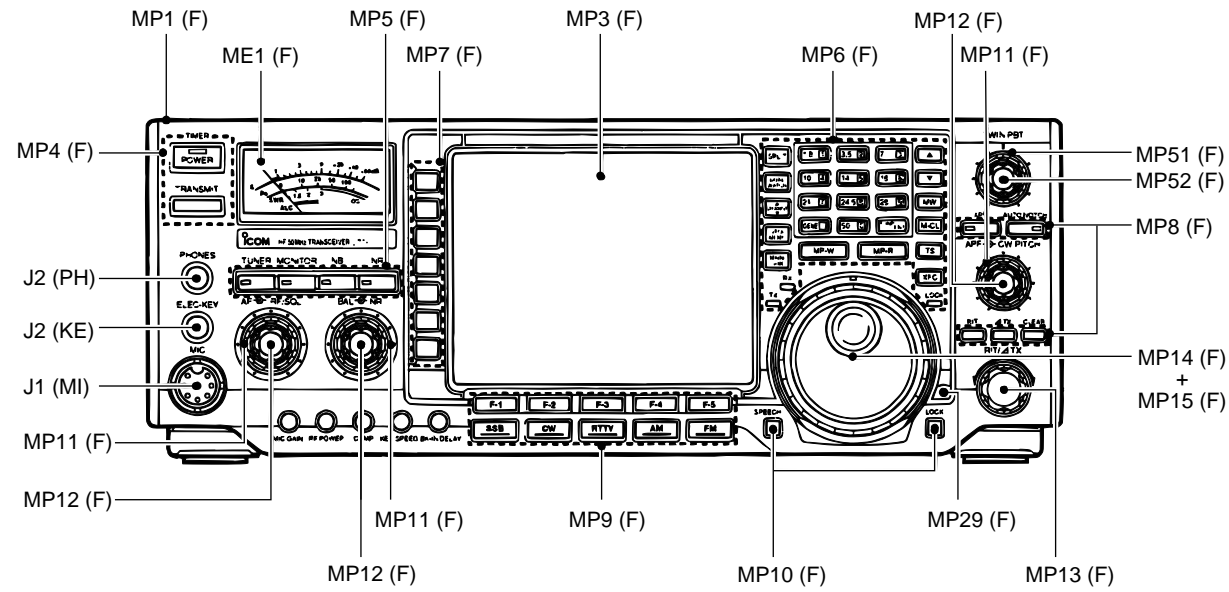

Unit abbreviations (F) : FRONT UNIT (C) : CHASSIS PARTS (PB) : PBT BOARD (RI) : RIT BOARD (DIS) : DISPLAY BOARD (MI) : MIC BOARD (KE) : KEY BOARD (PH) : PHONE BOARD

[CHASSIS PARTS]

REF. NO.	ORDER NO.	DESCRIPTION	QTY.
MP28	8810008660	Screw PH BT M3 × 8 NI-ZU	2
MP29	8810001650	Screw PH FT M3 × 6	2
MP30	8810001650	Screw PH FT M3 × 6	2
MP31	8810008660	Screw PH BT M3 × 8 NI-ZU	4
MP32	8810008660	Screw PH BT M3 × 8 NI-ZU	7
MP33	8810008660	Screw PH BT M3 × 8 NI-ZU	5
MP34	8810008660	Screw PH BT M3 × 8 NI-ZU	4
MP35	8810008660	Screw PH BT M3 × 8 NI-ZU	4
MP36	8810008660	Screw PH BT M3 × 8 NI-ZU	8
MP37	8810008660	Screw PH BT M3 × 8 NI-ZU	7
MP38	8810008660	Screw PH BT M3 × 8 NI-ZU	4
MP39	8810008660	Screw PH BT M3 × 8 NI-ZU	1
MP40	8810008660	Screw PH BT M3 × 8 NI-ZU	1
MP41	8810008160	Hex volt M5 × 18 NI (+)	1
MP42	8830000210	Nut M5 NI BS	1
MP43	8830000360	Wing nut M5 NI	1
MP44	8850000150	Flat washer M5 NI BS	3
MP45	8850000440	Spring washer M5 NI	1
MP46	8810003170	Setscrew A M3 × 8	4
MP47	8810003170	Setscrew A M3 × 8	4
MP48	8810000420	Screw PH M4 × 18	4
MP49	8810009310	Screw FH BT M3 × 6 NI-ZU	4
MP50	8930043340	Non-woven sheet (BP)	2
MP51	8930042690	Rubber foot (L)	2
MP53	8010018060	Carrying handle (A)	1
MP57	8930027900	Sponge (DD)	2
MP58	8930038820	Alumi sheet (V)	1
MP61	8810003160	Setscrew A M3 × 6	2
MP63	8810003160	Setscrew A M3 × 6	2
MP65	8930043281	Sponge (EW)-1	1
MP66	8930043800	Tape (S)	1
MP67	8930029050	Non-woven sheet (AL)	1
MP68	8930032130	Non-woven sheet (AQ)	2
MP69	8930029050	Non-woven sheet (AL)	1
MP70	8930008670	Sponge (AQ)	2
MP71	8930043490	Sponge (FB)	1
MP72	8930007840	Non-woven sheet (K)	2
MP73	8930043600	Sponge (FE)	1
MP74	8930043480	Sponge (FA)	1
MP75	8930041160	Non-woven sheet (BO)	1
MP76	8930037830	Sponge (ED)	2
MP77	8930007840	Non-woven sheet (K)	4
MP79	8930035240	1546 TR-B crip	1
MP80	8930027940	1126 TR-B crip	1
MP81	8930017260	758 module earth spring	1
MP83	8930043090	Sponge (EV)	1
MP84	8930011900	SP net (A)	1

[MAIN UNIT]

REF. NO.	ORDER NO.	DESCRIPTION	QTY.
BT3501	3020000110	Lithium battery CR2030	1
MP1	8930014140	Earth spring (D)	1
MP2	8510012770	2178 A-shield cover	1
MP3	8510012780	2178 A-shield case	1
MP4	8930051480	2178 earth plate	1

[TUNER UNIT]

REF. NO.	ORDER NO.	DESCRIPTION	QTY.
MF1	2710000460	Motor MP28GA	1
MF2	2710000460	Motor MP28GA	1
MP1	8930041090	1876 A-angle	1
MP2	8810008660	Screw PH BT M3 × 8 NI-ZU	1
MP3	8810009060	Screw FH M3 × 6 ZK	4
MP4	8930041110	1876 B-angle	1
MP5	8810009060	Screw FH M3 × 6 ZK	2
MP6	8820000880	1528 screw	4
MP7	8930030111	1414 plate-1	2
MP8	8950003200	UJ6-5 (universal couplings)	2

[RF UNIT]

REF. NO.	ORDER NO.	DESCRIPTION	QTY.
J111	6450001130	Connector JPJ2042-01-110	1
MP501	8510000230	220 shield case	1
MP502	8510000241	220 shield cover-1	1
MP601	8510000230	220 shield case	1
MP602	8510000241	220 shield cover-1	1
MP711	8930028380	Enbos tape (C)	1
MP712	8930014140	Earth spring (D)	1
MP721	8510000230	220 shield case	1
MP722	8510000241	220 shield cover-1	1
MP741	8510005150	602 shield case	1
MP742	8510005160	602 shield cover	1
MP811	8510000230	220 shield case	1
MP812	8510000241	220 shield cover-1	1
MP831	8510005150	602 shield case	1
MP832	8510005160	602 shield cover	1
MP901	8510002280	VCO shield plate (A)	1
MP903	8510002280	VCO shield plate (A)	1
MP904	8510002280	VCO shield plate (A)	1
MP907	8930028380	Enbos tape (C)	1

[PLL UNIT]

REF. NO.	ORDER NO.	DESCRIPTION	QTY.
MP1	8930014140	Earth spring (D)	1
MP51	8510000230	220 shield case	1
MP101	8510010760	1876 DDS case	1
MP102	8510010770	1876 DDS cover	1
MP103	8510005330	Coil case	1
MP151	8510012550	2178 DDS case	1
MP152	8510012580	2178 VCO cover	1
MP201	8510012540	2178 VCO case	1
MP202	8510011520	2072 VCO cover	1
MP203	8510011710	2072 VCO shield plate	1
MP204	8810003960	Setscrew A M2.6 × 5	8
MP301	8510005980	724 shield case	1
MP302	8510005990	724 shield cover	1
MP401	8510010760	1876 DDS case	1
MP402	8510010770	1876 DDS cover	1
MP403	8510005330	Coil case	1
MP451	8510012550	2178 DDS case	1
MP452	8510012580	2178 DDS cover	1
MP501	8510012540	2178 VCO case	1
MP502	8510011520	2072 VCO cover	1
MP503	8510011710	2072 VCO shield plate	1
MP504	8810003960	Setscrew A M2.6 × 5	1
MP601	8510005980	724 shield case	1
MP602	8510005990	724 shield cover	1
MP701	8510005980	724 shield case	1
MP702	8510005990	724 shield cover	1
MP801	8510012550	2178 DDS case	1
MP802	8510012580	2178 DDS cover	1
MP803	8510010150	1691 D/A case	1
MP901	8510005980	724 shield case	1
MP902	8510005990	724 shield cover	1

[CTRL UNIT]

REF. NO.	ORDER NO.	DESCRIPTION	QTY.
MP1	8510002020	MIX shield case	1

[UNPACKING]

REF. NO.	ORDER NO.	DESCRIPTION	QTY.
F1	5210000090	Fuse FGB 30A	2
F2	5210000060	Fuse FGB 5A	1
MC1	Optional product	Hand microphone HM-36	1
W1	Optional product	DC power cable OPC-025D	1

Screw abbreviations BT: Self-tapping FT: Self-tapping PH: Pan head FH: Flat head BiH: Bind head NI-ZU: Nickel-zinc NI: Nickel BS: Brass ZK:Black

SECTION 7 SEMI-CONDUCTOR INFORMATION

• TRANSISTOR AND FET'S

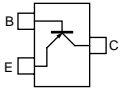
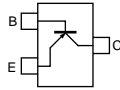
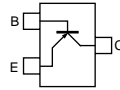
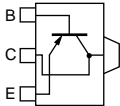
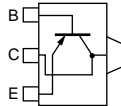
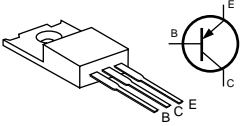
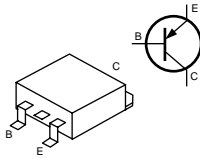
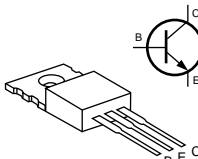
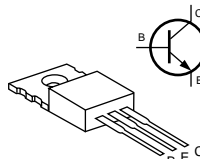
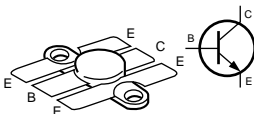
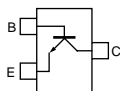
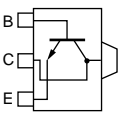
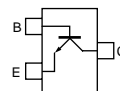
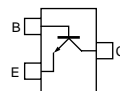
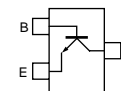
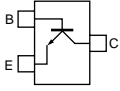
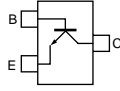
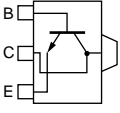
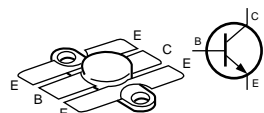
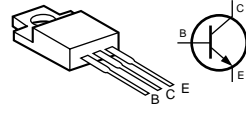
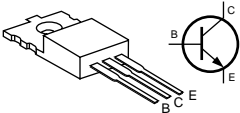
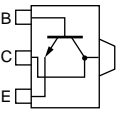
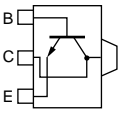
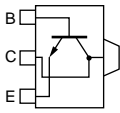
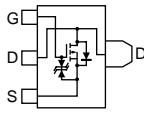
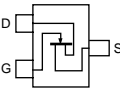
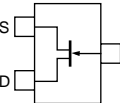
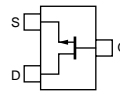
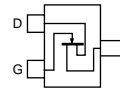
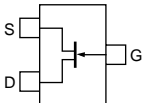
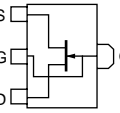
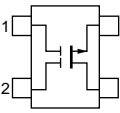
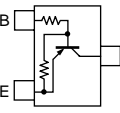
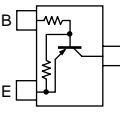
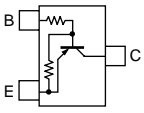
2SA1162 GR (Symbol: SG) 	2SA1576A T106R (Symbol: FR) 	2SA1577 (Symbol: HP) 	2SB1124 S TD (Symbol: BG) 	2SB1132 R (Symbol: BARB) 
2SB1133 R (Symbol: None) 	2SB1201 S (Symbol: B1201) 	2SC1971 (Symbol: None) 	2SC1972 (Symbol: None) 	2SC2694 (Symbol: None) 
2SC2714 O (Symbol: QO) 	2SC3647 S TD (Symbol: CC) 	2SC4081 T107 R (Symbol: BR) 	2SC4117 GR (Symbol: DG) 	2SC4213 B (Symbol: AB) 
2SC4403 3 TL (Symbol: LY3) 	2SC4405 3 TL (Symbol: OY3) 	2SC4673 D TD (Symbol: CO) 	2SC5125 	2SD1406 Y (Symbol: None) 
2SD1585 K (Symbol: None) 	2SD1619 T TD (Symbol: DB) 	2SD1664 T100Q (Symbol: DA) 	2SD1801 S TL (Symbol: CE) 	2SJ381 TD (Symbol: JI) 
2SK210 GR (Symbol: YG) 	2SK508 K52 T2B (Symbol: K52) 	2SK515 T1B (Symbol: X33) 	2SK882 GR (Symbol: TGR) 	2SK1740 (Symbol: IJ) 
2SK2171 4 TD (Symbol: KM) 	3SK131 T2 MAS (Symbol: V11) 	DTA114 EE TL (Symbol: 14) 	DTA114EUA T106 (Symbol: 14) 	DTA144 EE TL (Symbol: 16) 

DTB123 EK T147 (Symbol: F12) 	DTC114 EE TL (Symbol: 24) 	DTC114EU (Symbol: 14) 	DTC144 EE TL (Symbol: 26) 	UMC3N TR (Symbol: C3)
UMD3N TL (Symbol: D3) 	UMH11N TN (Symbol: H11) 	UN9211 (Symbol: 8A) 		

• DIODES

1SS226 (Symbol: C3) 	1SS301 (Symbol: B3) 	1SS302 (Symbol: C3) 	1SS319 (Symbol: A4) 	1SS322 (Symbol: A9)
1SS372 (Symbol: N9) 	1SS375-TL (Symbol: FH) 	1SV263 TL (Symbol: JV) 	1SV265 TL (Symbol: LV) 	DA221 TL (Symbol: K)
DAP222 TL (Symbol: P) 	DWA010 TE (Symbol: W8) 	HSB88WSTR (Symbol: Silver line) 	HSM88ASR TR (Symbol: C3) 	HSM88AS TR (Symbol: C1)
KV1470 TL (Symbol: F7) 	MA29B (Symbol: Y) 	RD3.0M T2B2 (Symbol: 302) 	RD5.1M T2B2 (Symbol: 512) 	RD5.6M T2B2 (Symbol: 562)
RD20M T2B1 (Symbol: 201) 	SB10 05PCP TD (Symbol: SA) 			

SECTION 8 BOARD LAYOUTS

8-1 PBT, RIT AND MIC BOARDS

• PBT BOARD

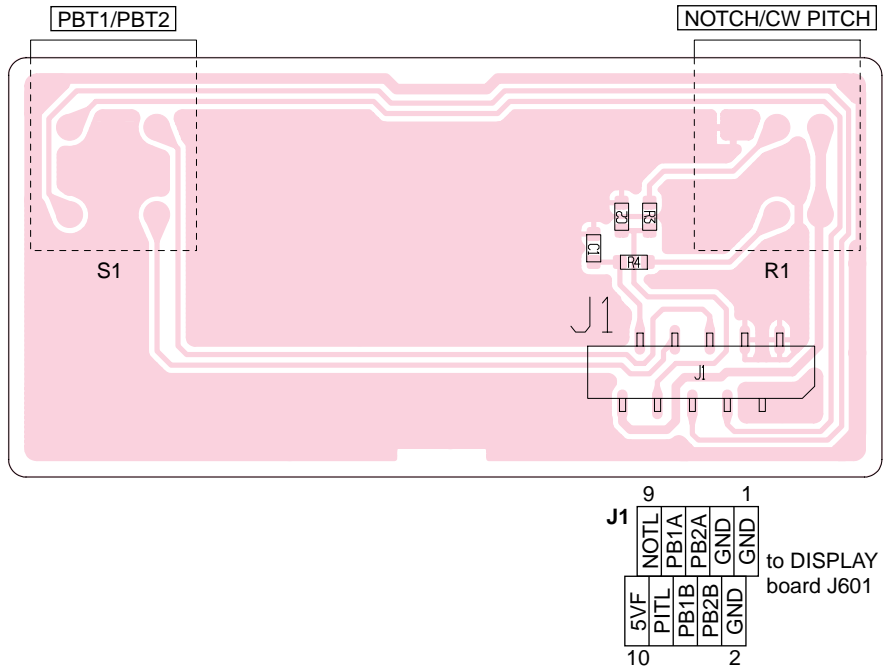

• RIT BOARD

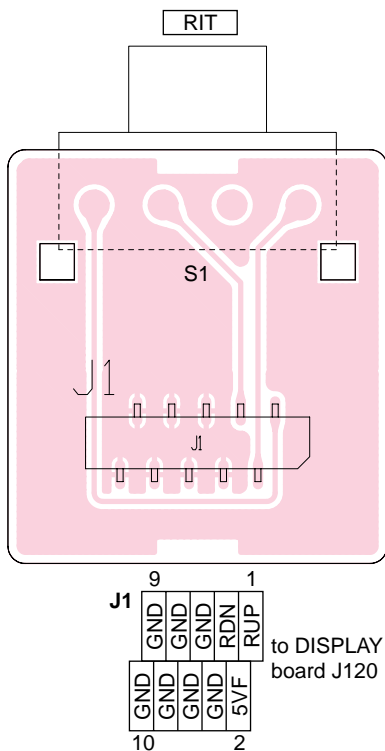

• MIC BOARD

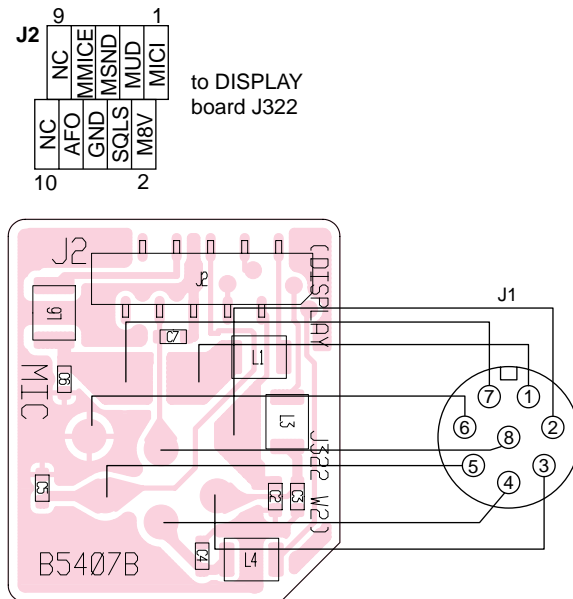

8-2 DISPLAY BOARD

• DISPLAY BOARD (TOP VIEW)

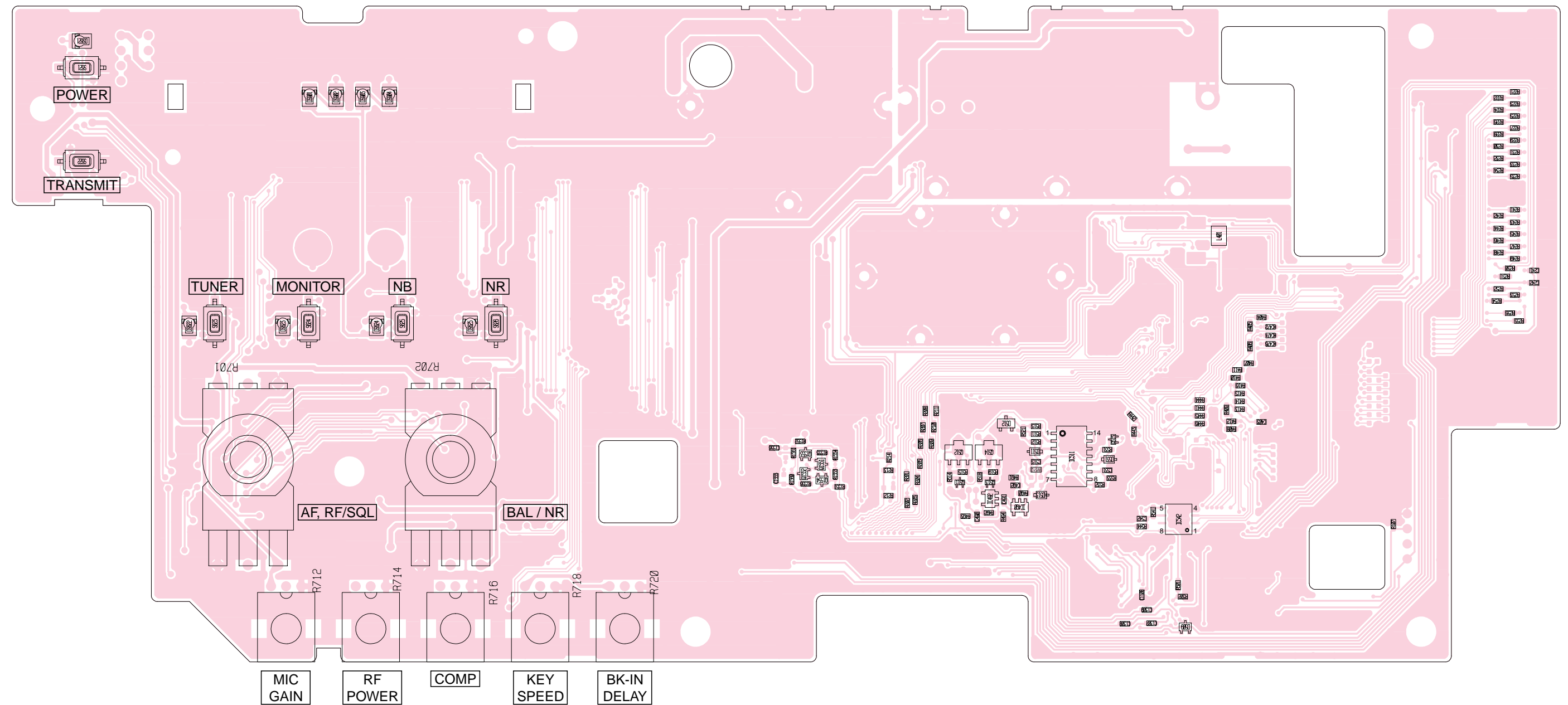

• DISPLAY BOARD (BOTTOM)

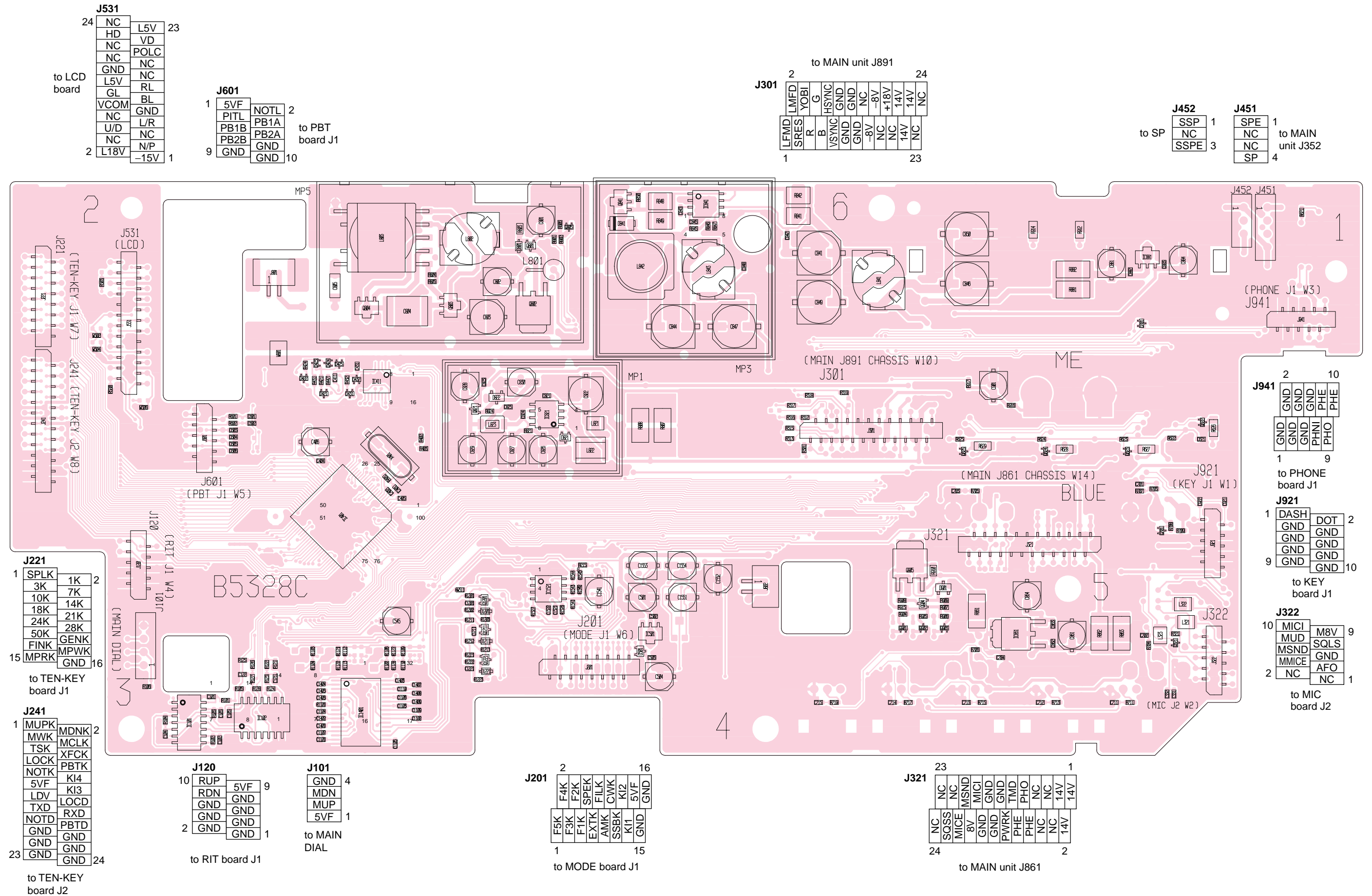

8-3 MODE, PHONE, KEY AND TEN-KEY BOARDS

• MODE BOARD (TOP VIEW)

• PHONE BOARD

• TEN-KEY BOARD (TOP VIEW)

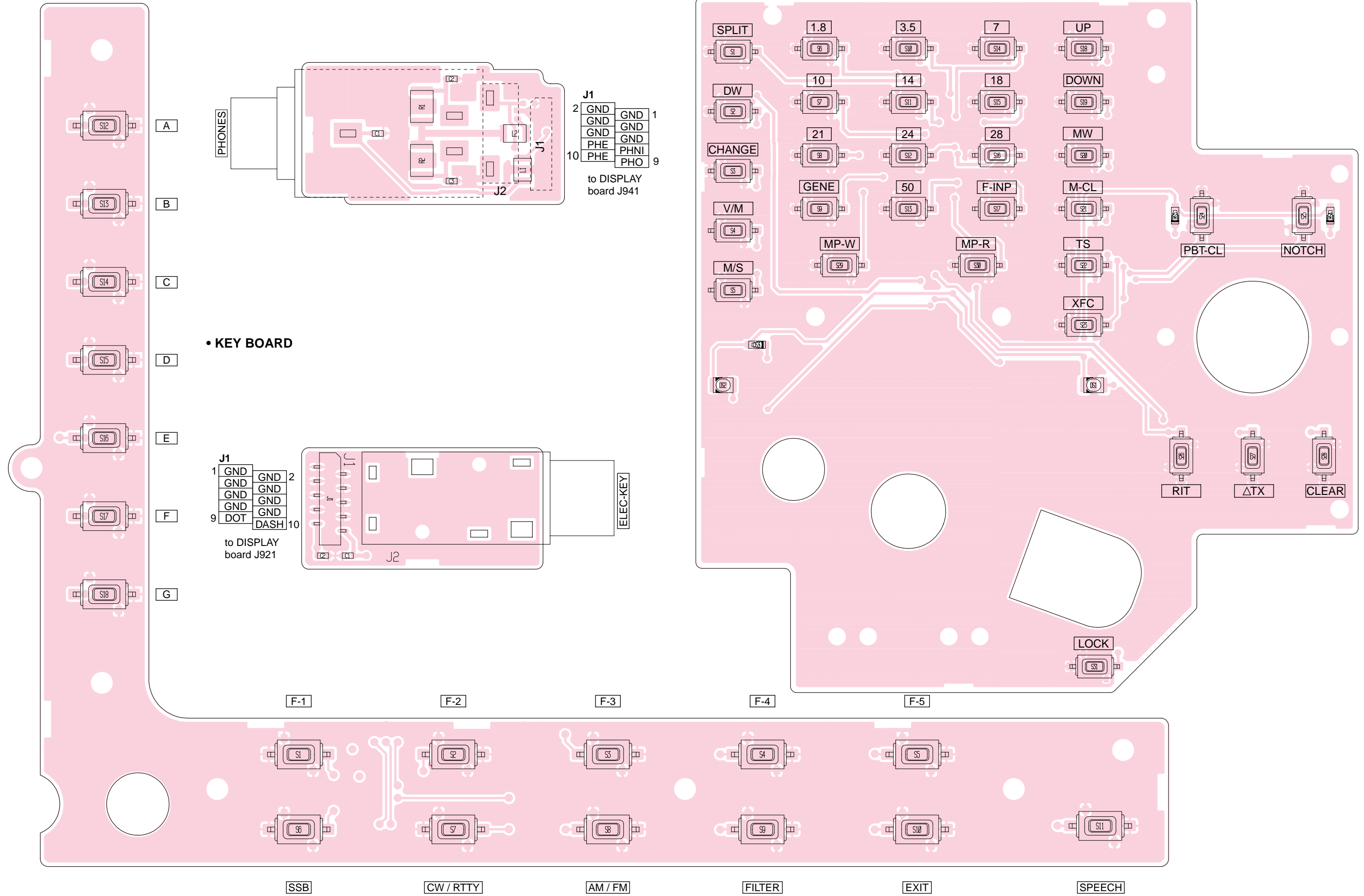

• TEN-KEY BOARD (BOTTOM

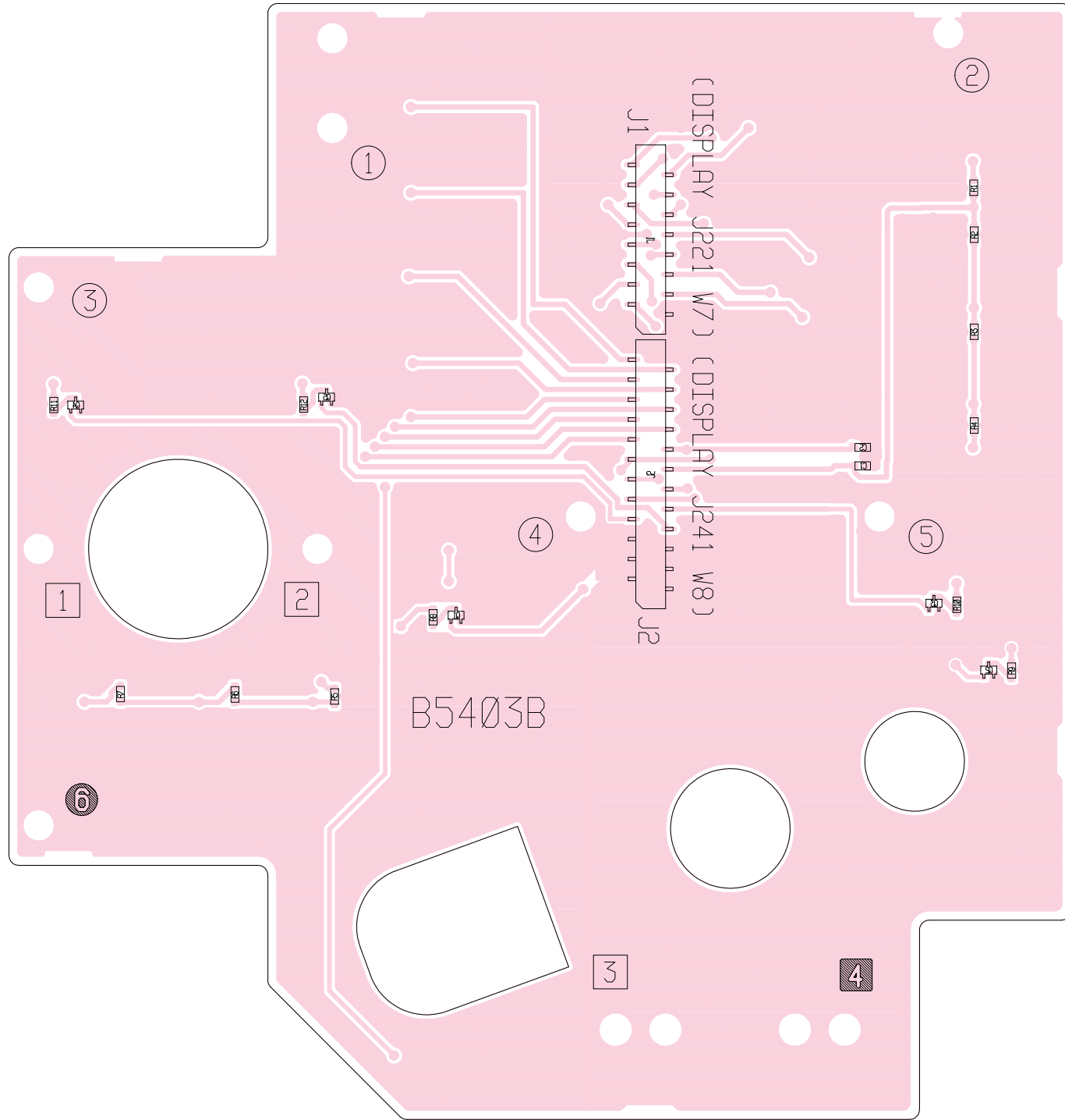

J1

16	SPLK	1K	15
	3K	7K	
	10K	14K	to DISF
	18K	21K	board J
	24K	28K	
	50K	GENK	
	FINK	MPWK	
2	MPRK	GND	1

J2

24	MUPK	MDNK	23
	MWK	MCLK	
	TSK	XFCK	
	LOCK	PBTK	
	NOTK	KI4	to DISF
	5VF	KI3	board J
	LDV	LOCD	
	TXD	RXD	
	NOTD	PBTD	
	GND	GND	
	GND	GND	
2	GND	GND	1

to DISPLAY board J201

J1

15	GND	KI1	1
	SSBK	AMK	
	CWK	EXTK	
	FILK	F1K	
	SPEK	F2K	
	F2K	F3K	
	F4K	F5K	
16	GND	5VF	2
	KI2		

• MODE BOARD (BOTTOM VIEW)

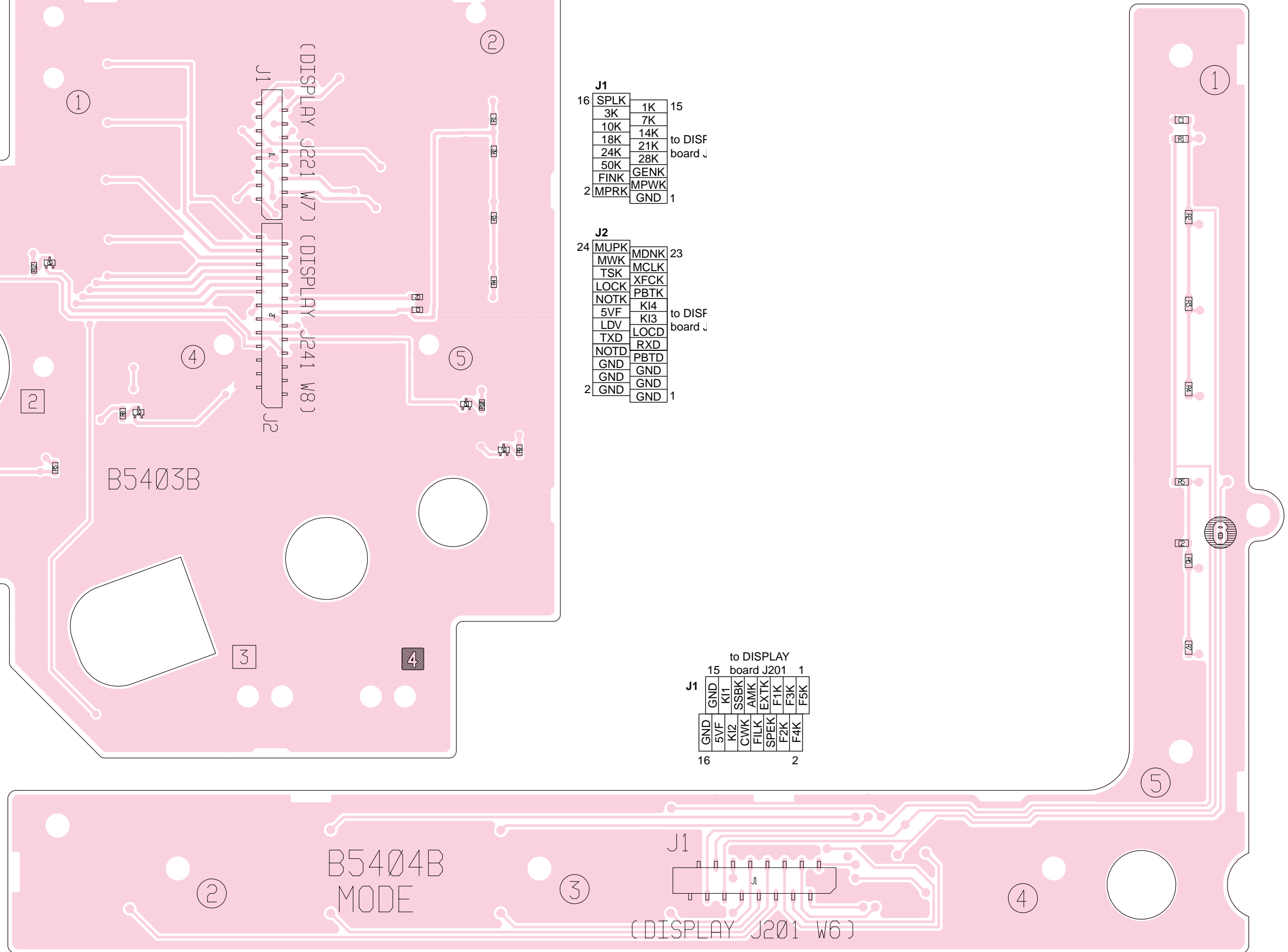

• RF UNIT (BOTTOM VIEW)

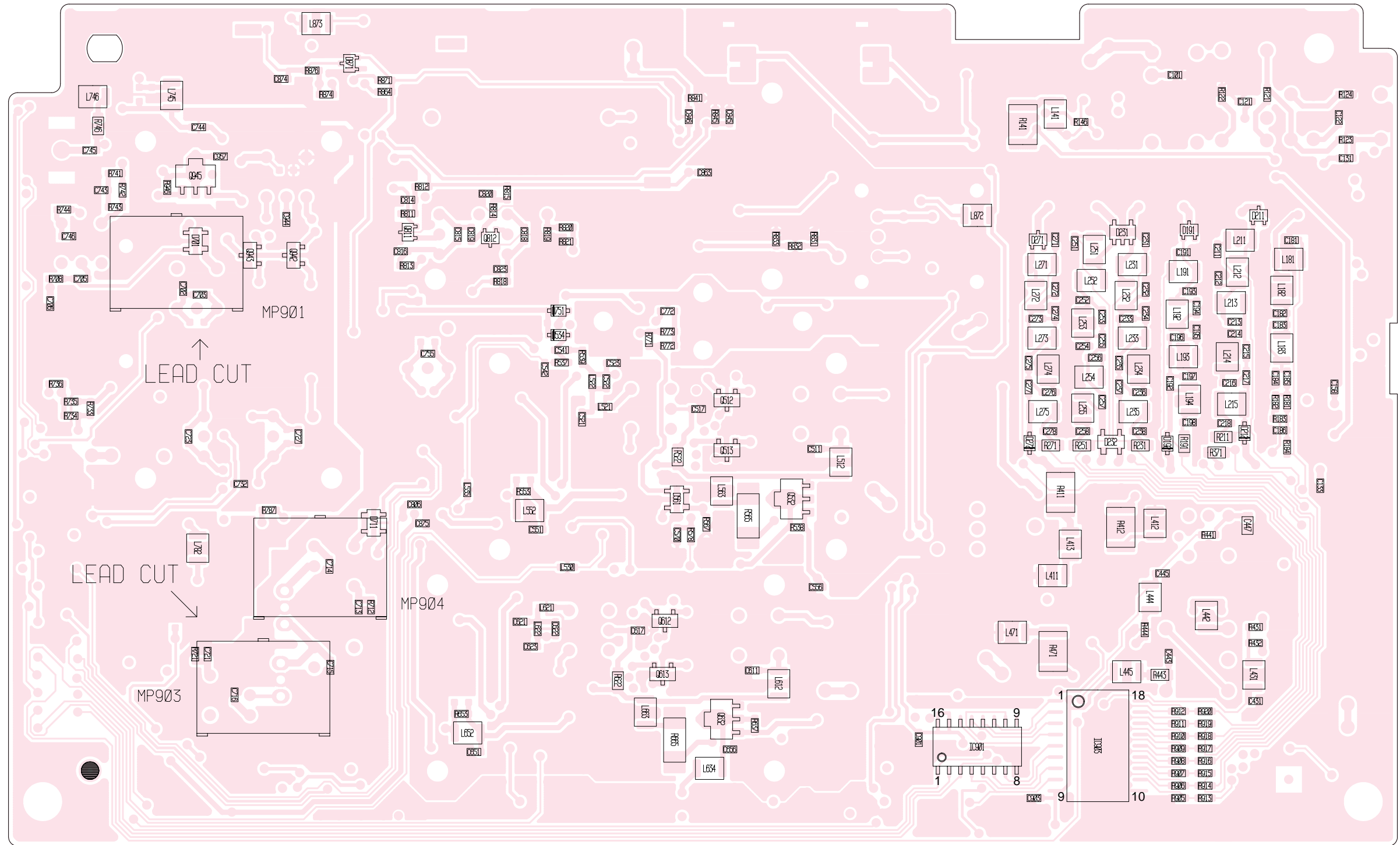

• PLL UNIT (BOTTOM VIEW)

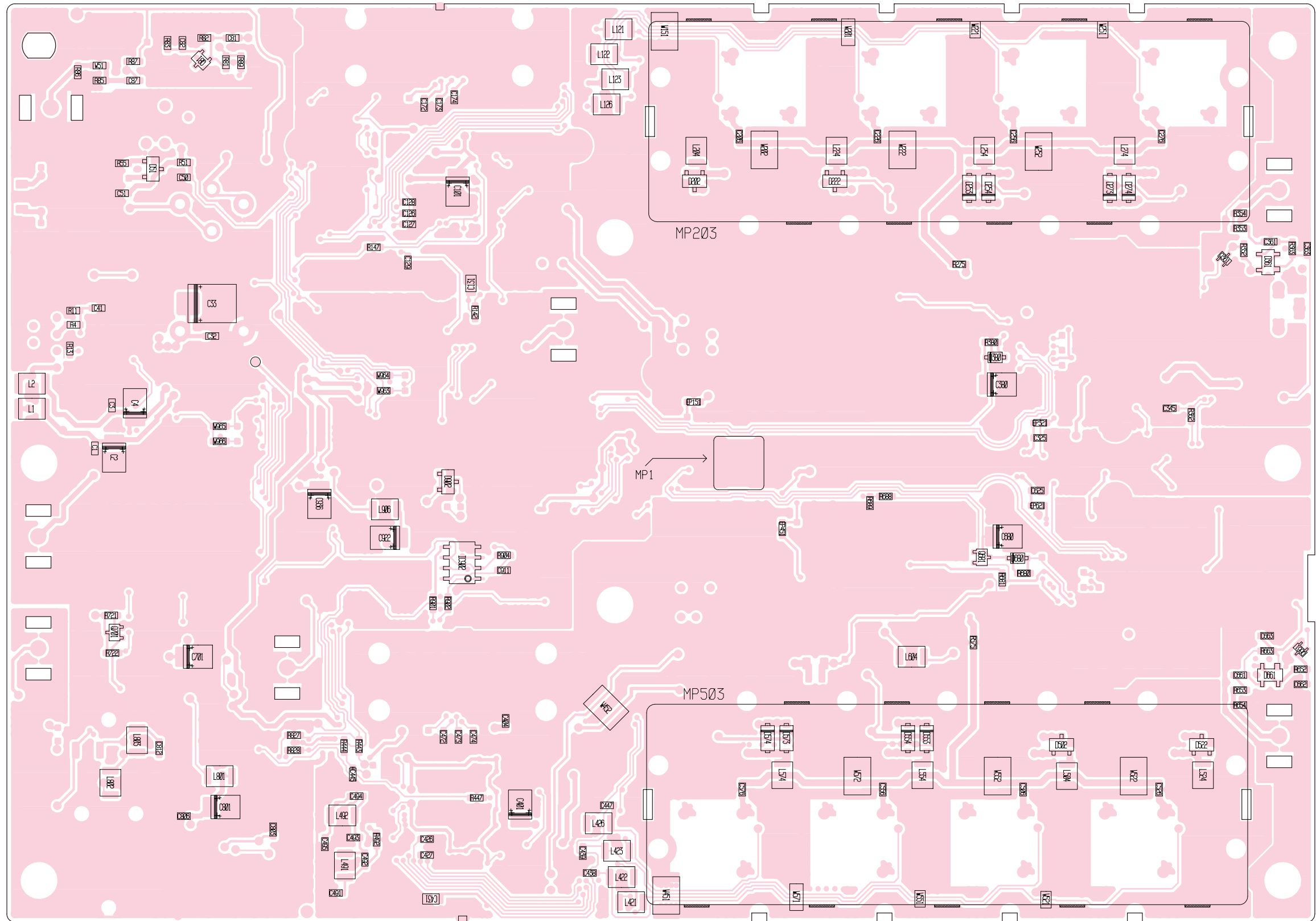

8-6 MAIN UNIT (TOP VIEW)

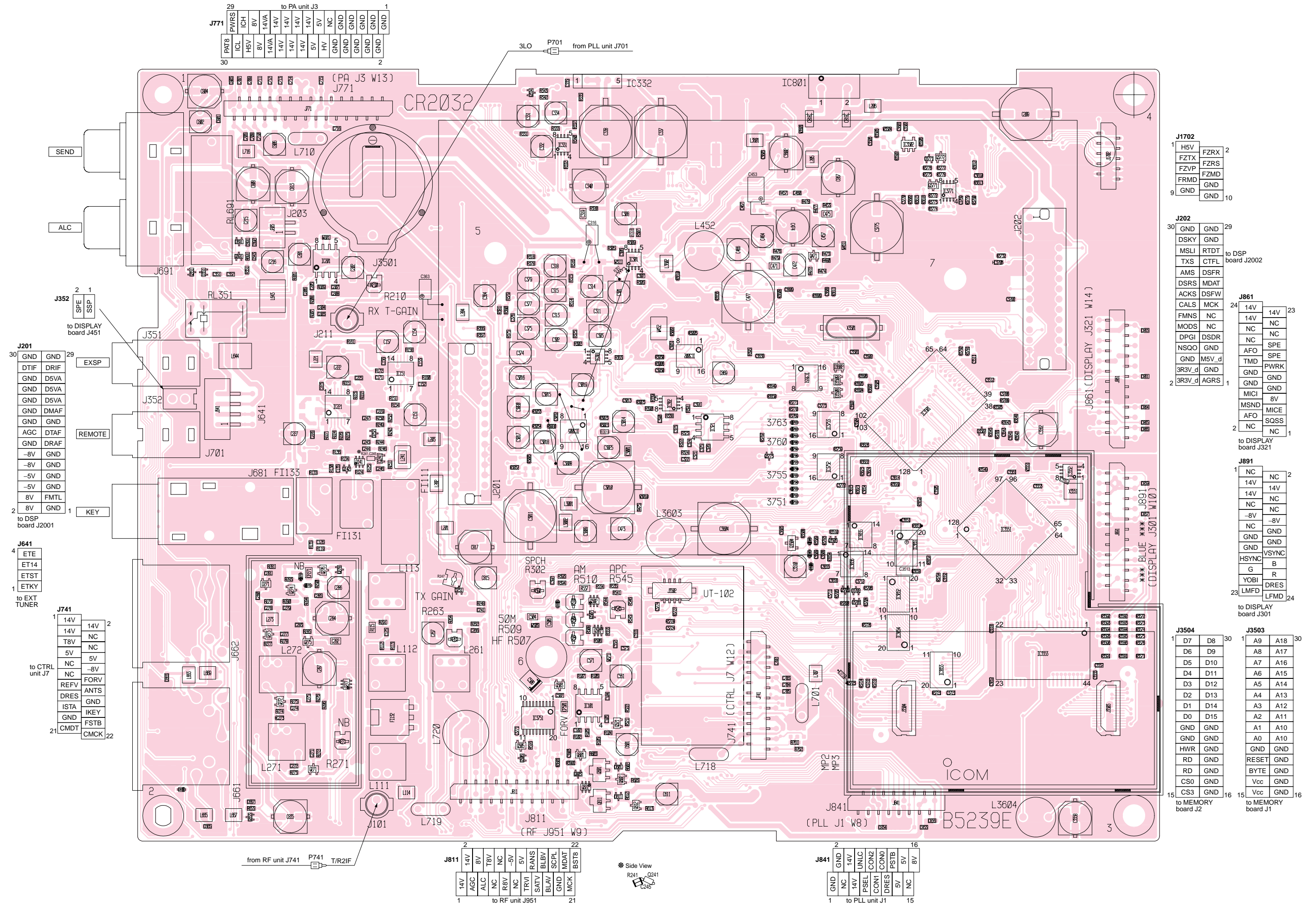

• MAIN UNIT (BOTTOM VIEW)

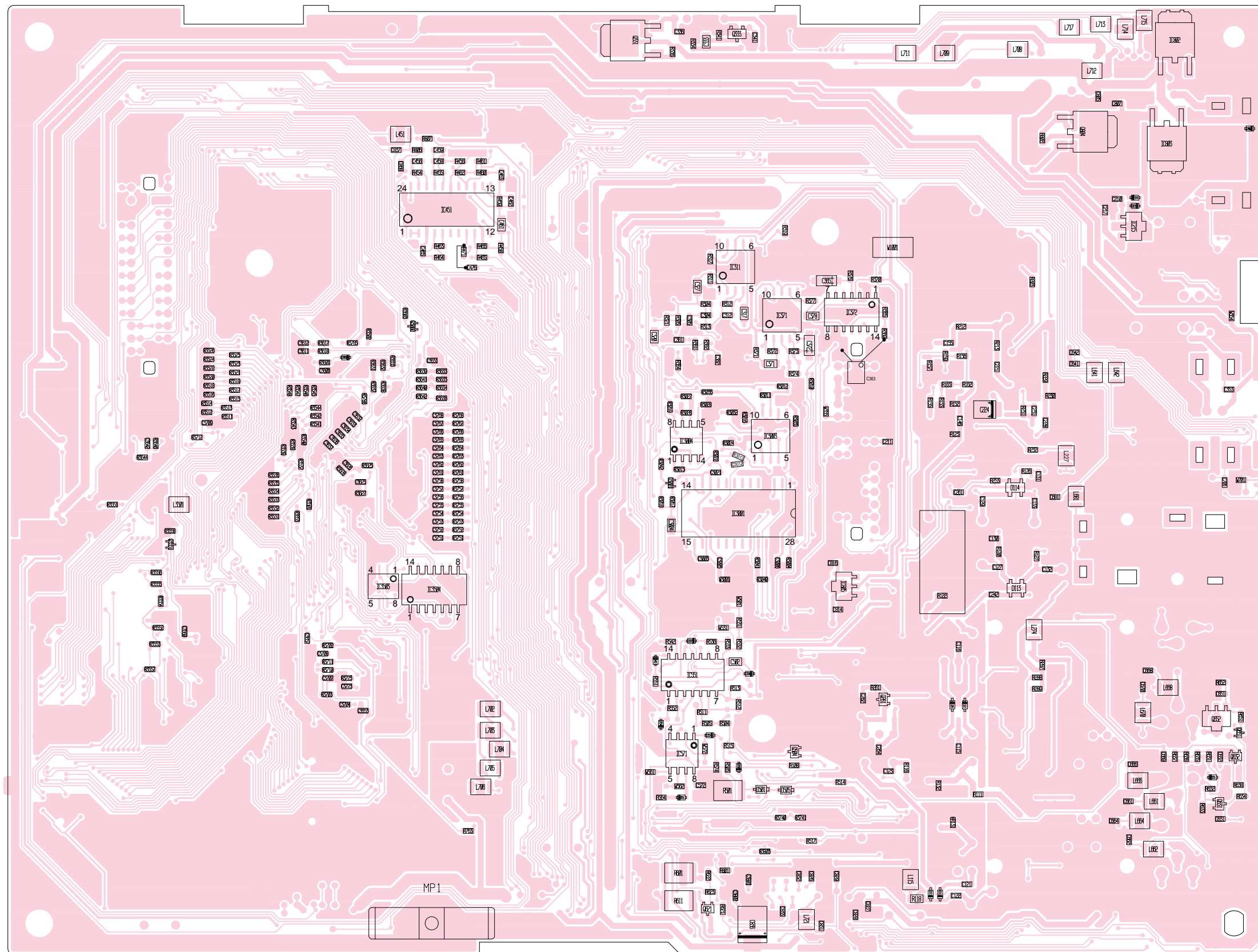

8-8 MEMORY BOARD

to MAIN unit J3504

J2	1	D7	D6	D5	D4	D3	D2	D1	D0	GND	GND	GND	HWR	RD	RD	CS0	CS3	15
	30	D8	D9	D10	D11	D12	D13	D14	D15	GND	GND	GND	GND	GND	GND	GND	GND	GND

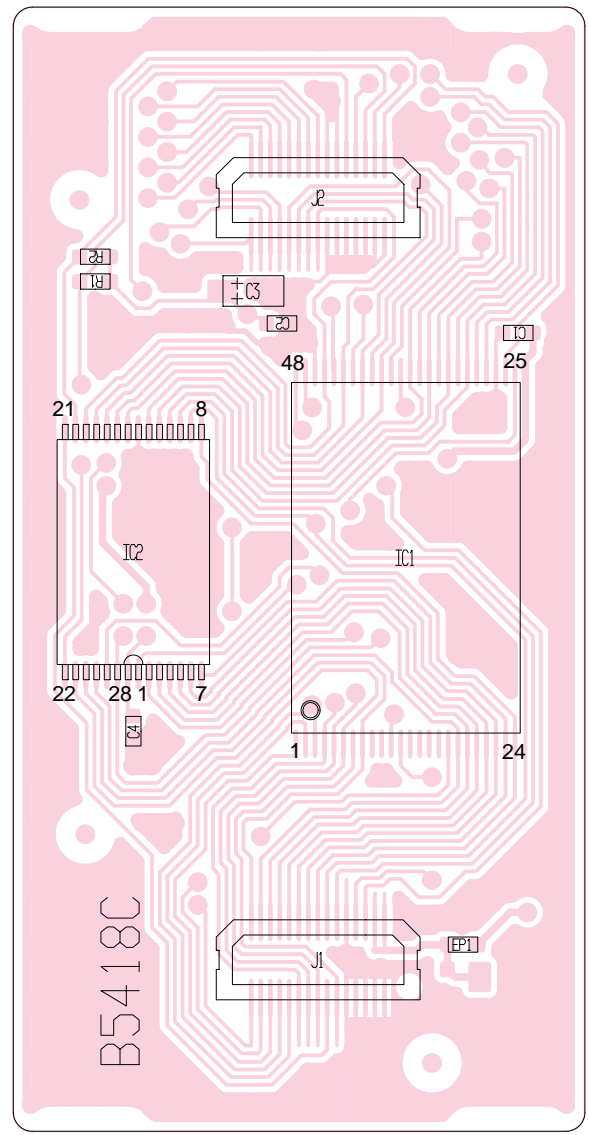

J1	1	A9	A8	A7	A6	A5	A4	A3	A2	A1	A0	GND	GND	RESET	BYTE	Vcc	Vcc	15
	30	A18	A17	A16	A15	A14	A13	A12	A11	A10s	A10f	GND	GND	GND	GND	GND	GND	16

to MAIN unit J3503

8-9 PA UNIT

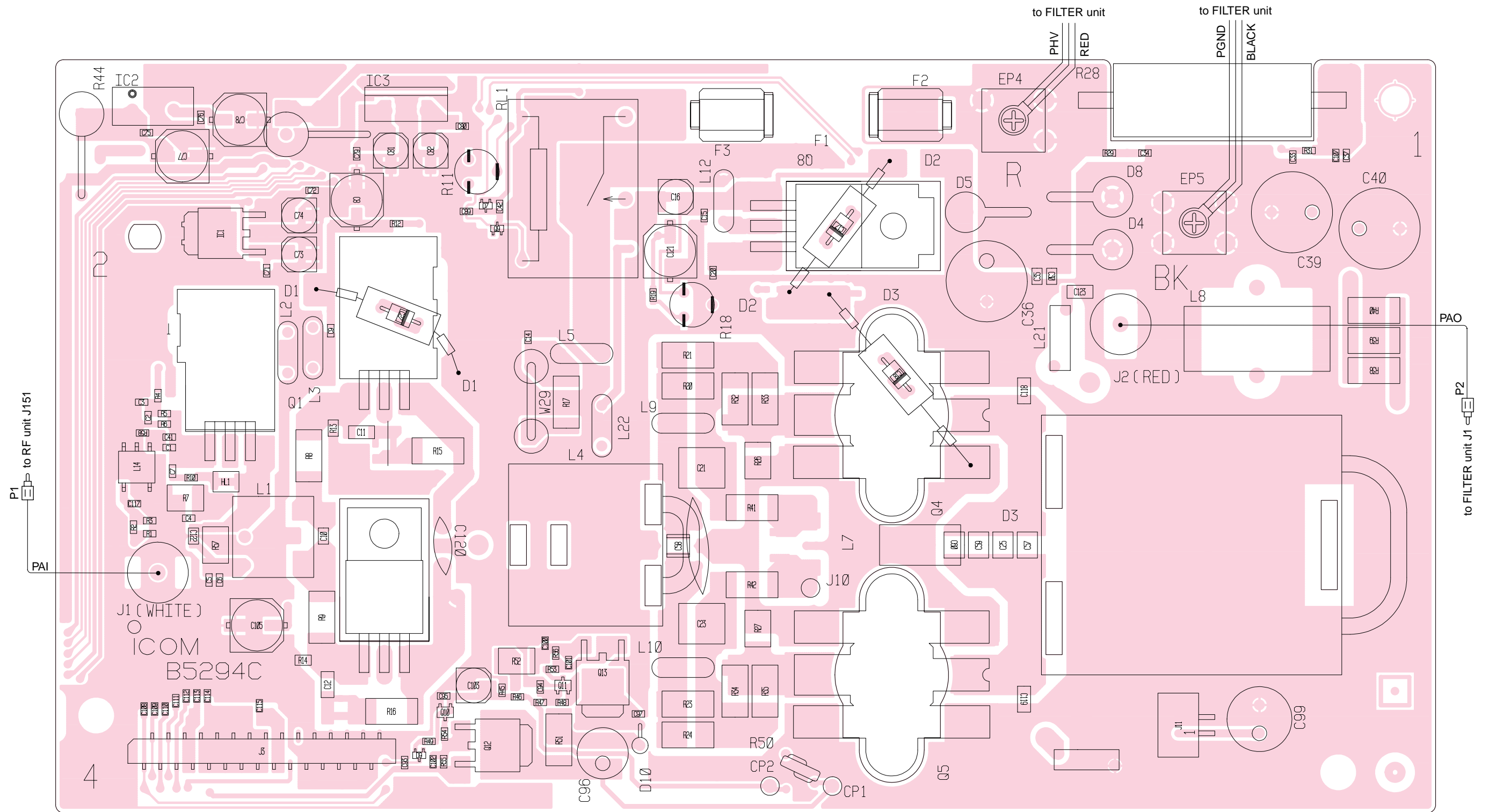

J3		2	PWRS	30
1	PAT8	1	ICH	29
	ICL		8V	
	H5V		14VA	
	8V		14V	
	14VA		14V	
	14V		14V	
	14V		14V	
	5V		5V	
	HV		NC	
	GND		GND	
	GND		GND	
	GND		GND	
	GND		GND	
	GND		GND	
	GND		GND	
	GND		GND	

to MAIN unit J771

J11		
2	MF-	to CHASSIS
1	MF+	MF1

8-11 TUNER BOARD

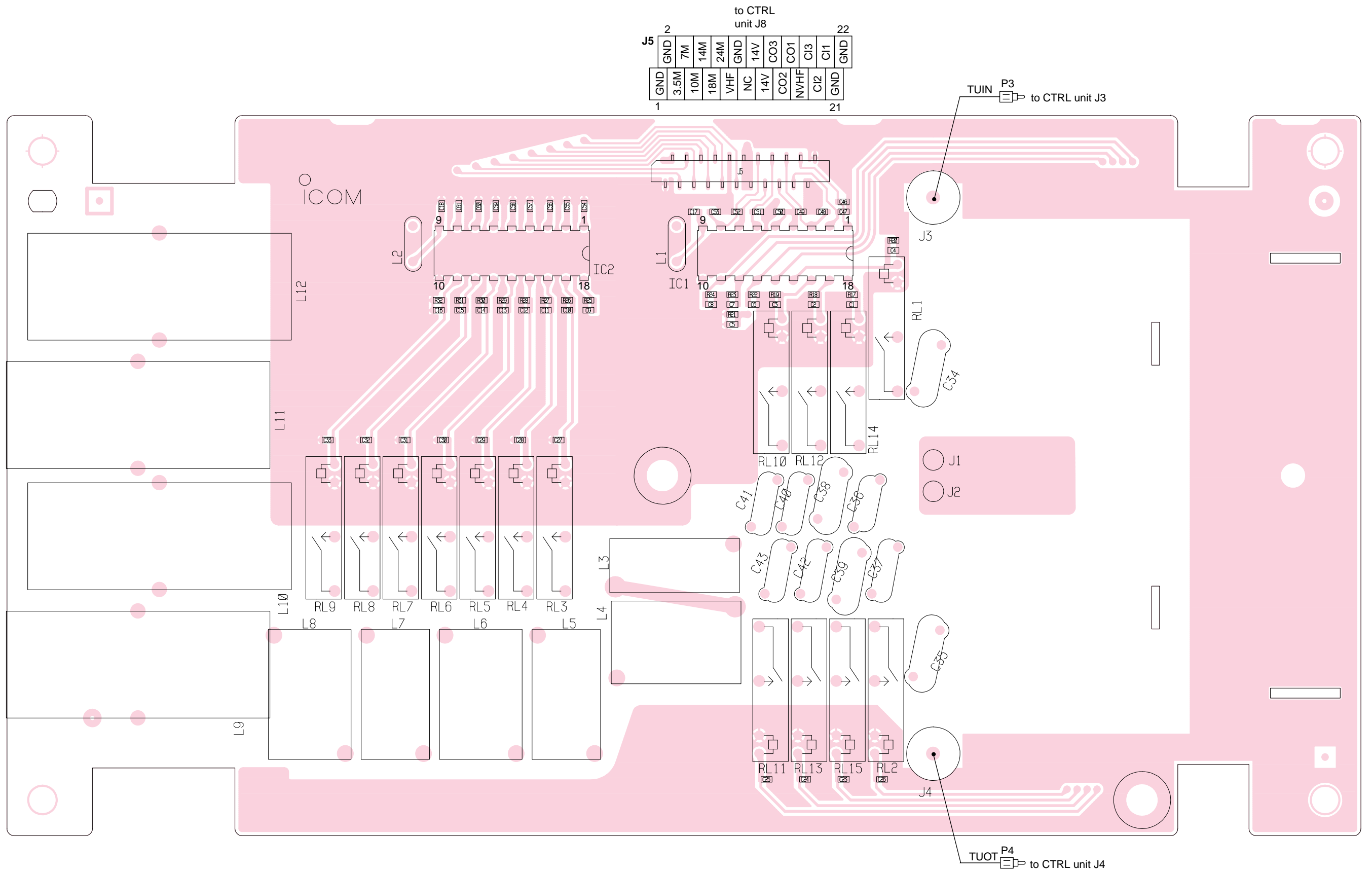

SECTION 9 BLOCK DIAGRAM

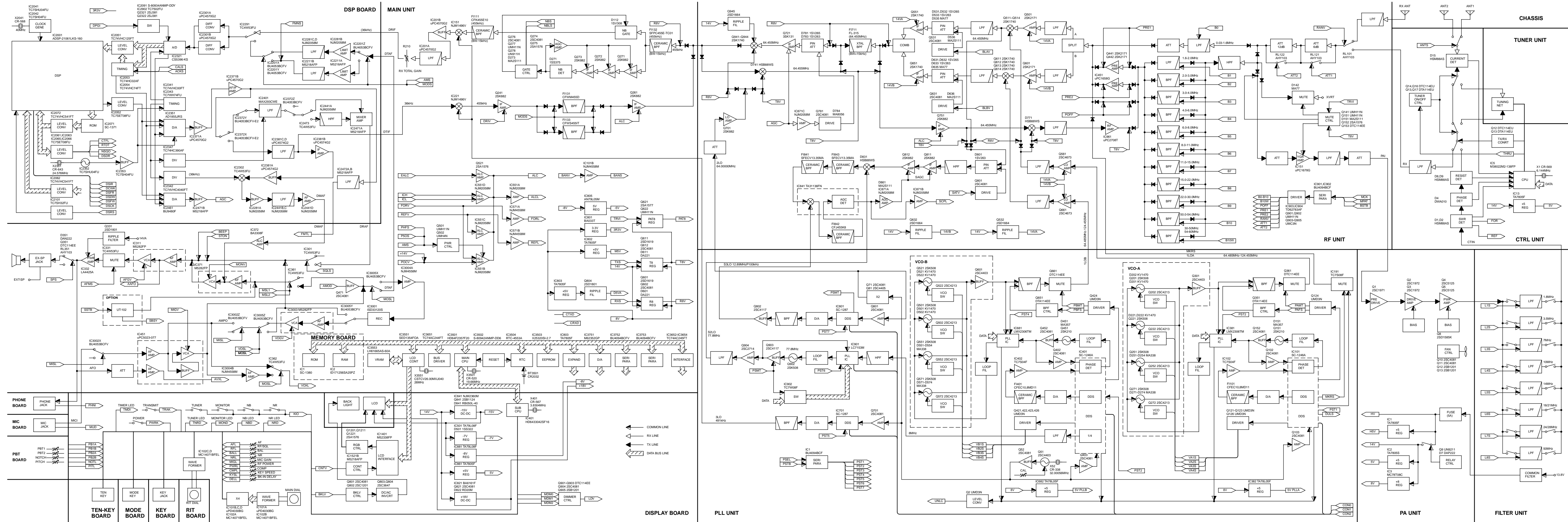

10-3 TUNER, MEMORY BOARDS AND CTRL UNIT

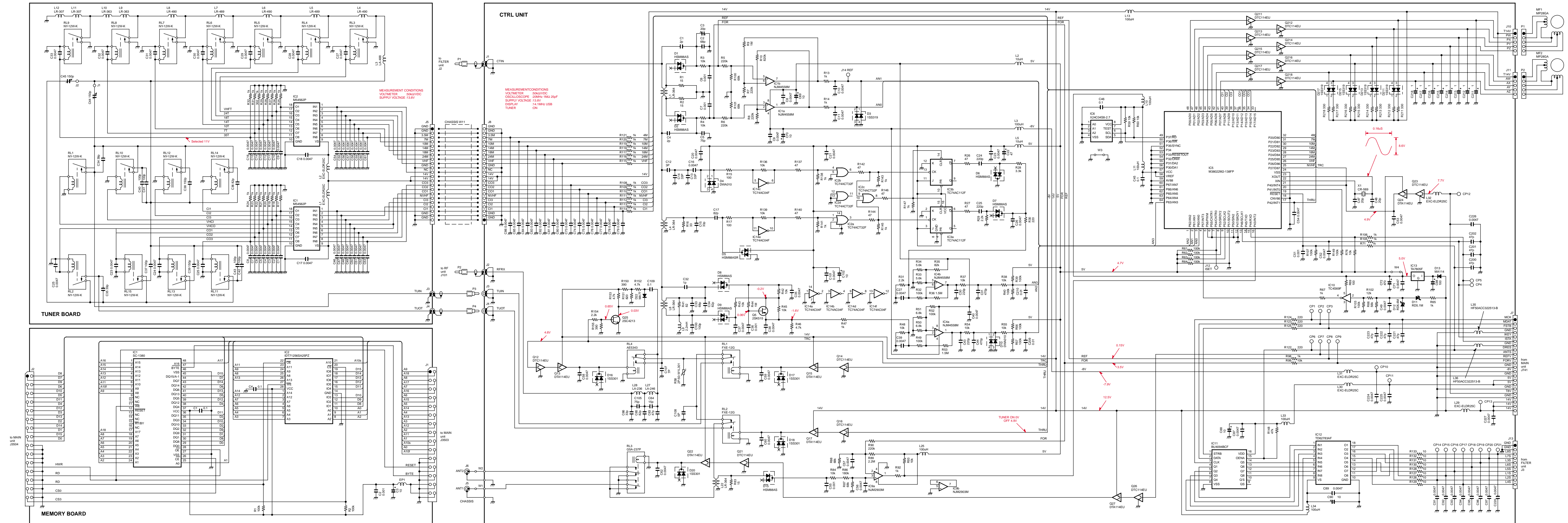

10-4 MAIN UNIT (1)

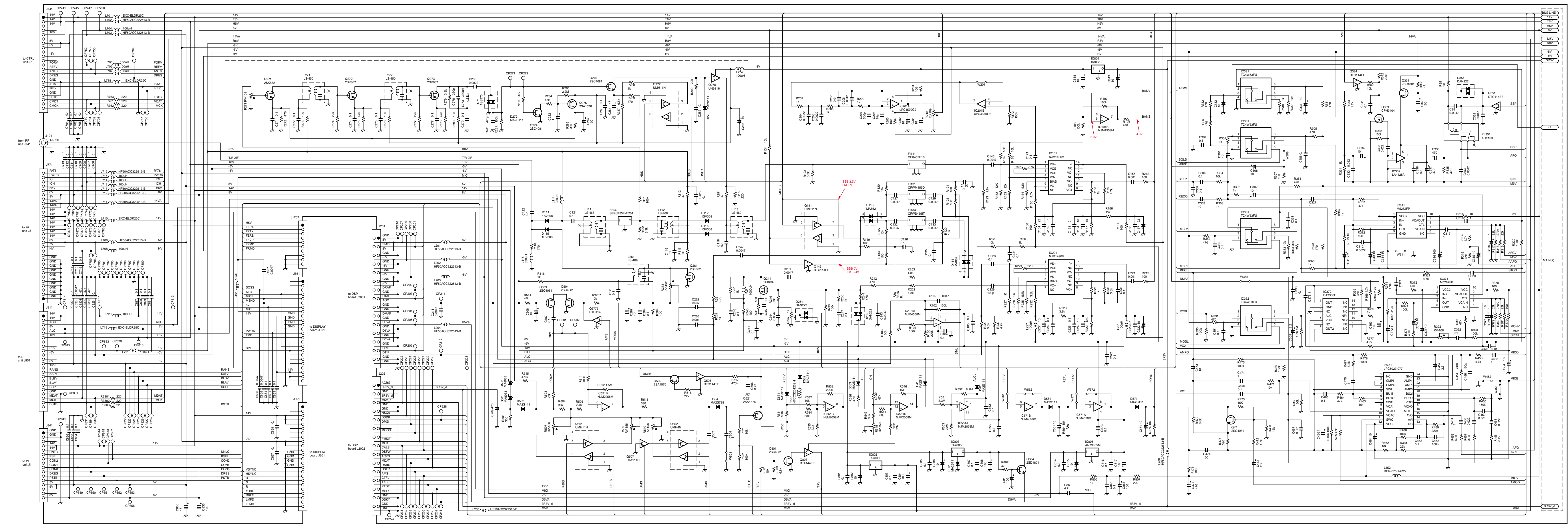

10-5 MAIN UNIT (2)

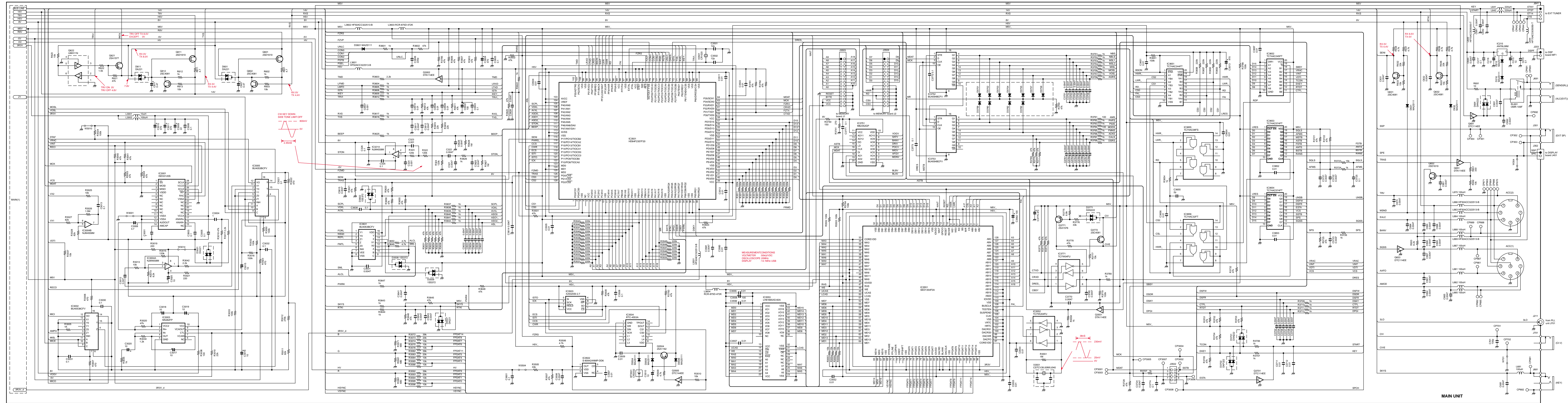

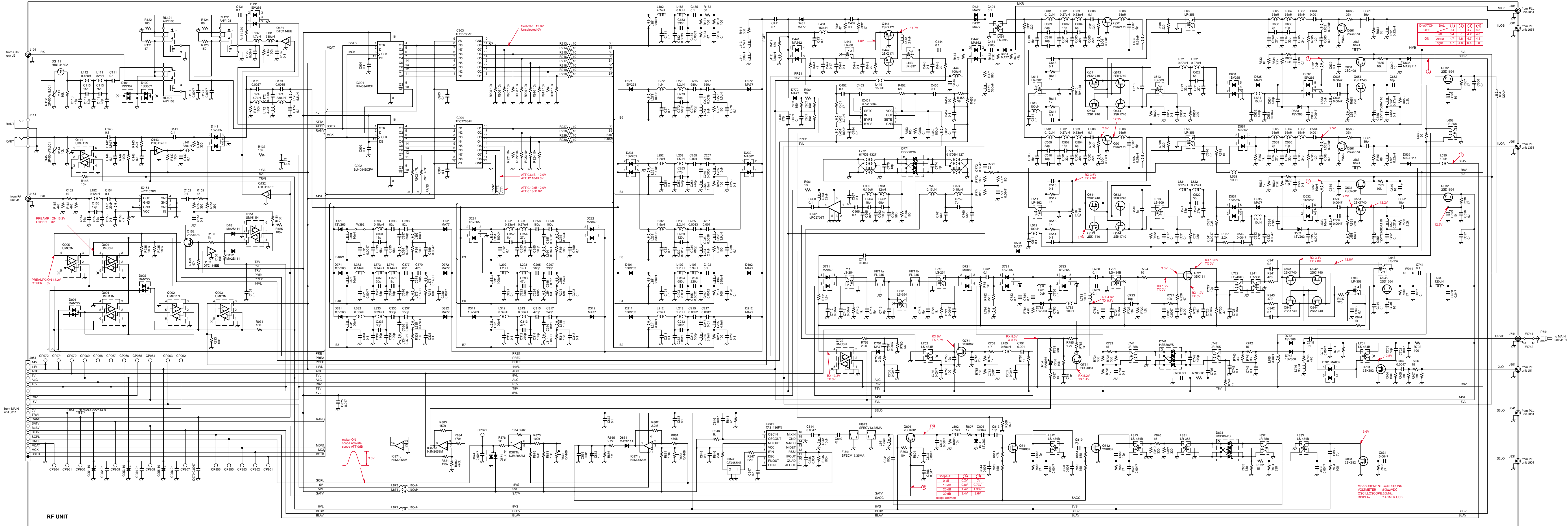

Icom Inc.

6-9-16, Kamihigashi, Hirano-ku, Osaka 547-0002, Japan
Phone : 06 6793 5302
Fax : 06 6793 0013

Icom America Inc.

<Corporate Headquarters>
2380 116th Avenue N.E., Bellevue, WA 98004, U.S.A.
Phone : (425) 454-8155 Fax : (425) 454-1509
URL : <http://www.icomamerica.com>
<Customer Service>
Phone : (425) 454-7619

Icom Canada

3071 #5 Road, Unit 9, Richmond, B.C., V6X 2T4, Canada
Phone : (604) 273-7400 Fax : (604) 273-1900
URL : <http://www.icomcanada.com>

Icom (Australia) Pty. Ltd.

A.C.N. 006 092 575
290-294 Albert Street, Brunswick, Victoria, 3056, Australia
Phone : 03 9387 0666 Fax : 03 9387 0022
URL : <http://www.icom.net.au>

Asia Icom Inc.

6F No. 68, Sec. 1 Cheng-Teh Road, Taipei, Taiwan, R.O.C.
Phone : (02) 2559 1899 Fax : (02) 2559 1874

Icom (Europe) GmbH

Communication Equipment
Himmelgeister Str. 100, D-40225 Düsseldorf, Germany
Phone : 0211 346047 Fax : 0211 333639
URL : <http://www.icomeurope.com>

Icom Spain S.L.

Crta. de Gracia a Manresa Km. 14,750
08190 Sant Cugat del Valles Barcelona, SPAIN
Phone : (93) 590 26 70 Fax : (93) 589 04 46
URL : <http://www.icomspain.com>

Icom (UK) Ltd.

Unit 9, Sea St., Herne Bay, Kent, CT6 8LD, U.K.
Phone : 01227 741741 Fax : 01227 741742
URL : <http://www.icomuk.co.uk>

Icom France Sa

Zac de la Plaine, Rue Brindejonc des Moulinais
BP 5804, 31505 Toulouse Cedex, France
Phone : 561 36 03 03 Fax : 561 36 03 00
URL : <http://www.icom-france.com>

Count on us!

Icom Inc.

6-9-16, Kamihigashi, Hirano-ku Osaka 547-0002, Japan

S-13604HZ-C1

Printed in Japan

© 2000 Icom Inc.