

IC-R71A/E/D

COMMUNICATIONS RECEIVER

INSTRUCTION MANUAL

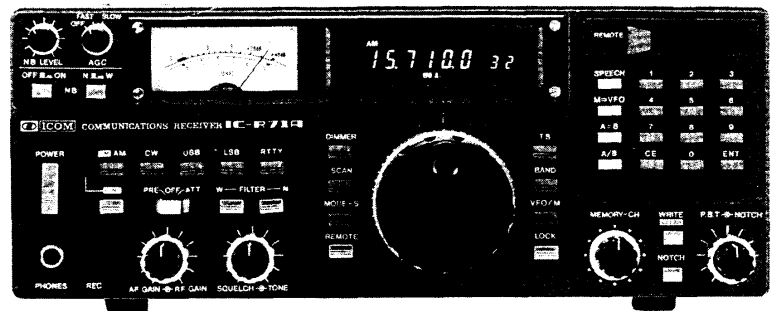

TABLE OF CONTENTS

| | | | |
|---------|------|-----------------------------------|----------|
| SECTION | 1 | SPECIFICATIONS | 1 |
| SECTION | 2 | FEATURES | 2 |
| SECTION | 3 | INSTALLATION | 3 |
| SECTION | 4 | OPERATING CONTROLS..... | 5 |
| | 4- 1 | FRONT PANEL..... | 5 |
| | 4- 2 | REAR PANEL..... | 8 |
| SECTION | 5 | OPERATING INSTRUCTIONS..... | 9 |
| | 5- 1 | HOW TO TUNE | 9 |
| | 5- 2 | MEMORY CHANNEL OPERATION | 11 |
| | 5- 3 | FREQUENCY SETTING BY KEY PAD..... | 13 |
| | 5- 4 | SCANNING OPERATION..... | 13 |
| | 5- 5 | SSB OPERATION | 14 |
| | 5- 6 | CW OPERATION..... | 16 |
| | 5- 7 | RTTY OPERATION | 16 |
| | 5- 8 | AM OPERATION..... | 17 |
| | 5- 9 | FM OPERATION (OPTION)..... | 17 |
| | 5-10 | OTHER OPERATIONS..... | 17 |
| SECTION | 6 | CIRCUIT DESCRIPTION | 18 |
| SECTION | 7 | INSIDE VIEWS | 19 |
| SECTION | 8 | OPTION INSTALLATION..... | 21 |
| SECTION | 9 | TROUBLESHOOTING..... | 25 |
| SECTION | 10 | BLOCK DIAGRAM..... | 26 |
| SECTION | 11 | SCHEMATIC DIAGRAM..... | SEPARATE |

SECTION 1 SPECIFICATIONS

GENERAL

Number of Semiconductors:

| | |
|-------------------|-----|
| Transistors | 90 |
| FET | 19 |
| IC (Includes CPU) | 47 |
| Diodes | 237 |

Frequency Coverage:

0.1MHz ~ 30MHz

(Australian Version: 2.0MHz ~ 30.0MHz)

(German Version: 0.15MHz ~ 26.1MHz)

Thirty 1MHz Segments

Frequency Control:

CPU based 10Hz step Digital PLL synthesizer with dual VFO system

Frequency Readout:

6 digit 100Hz readout.

Frequency Stability:

Less than 200Hz after switch on 1 min to 60 mins, and less than 30Hz after 1 hour. Less than 500Hz in the range of 0°C to +50°C

Power Supply Requirements:

117V or 235V ±10% 50 ~ 60Hz 30VA

(100V/200V/220V use requires internal modification)

Antenna Impedance:

50 ohms Unbalanced

(Single wire can be used on 0.1 ~ 1.6MHz)

Weight:

7.5 kg (16.5 lbs)

Dimensions:

111mm(H) x 286mm(W) x 276mm(D)

(4-3/8 inch x 11-1/4 inch x 10-7/8 inch)

RECEIVER

Receiving System:

Quadruple Conversion Superheterodyne with continuous

Bandwidth Control

(F₃*: Triple Conversion Superheterodyne)

Receiving Mode:

A₁, A₃J (USB, LSB), F₁ (Output FSK audio signal), A₃, F₃*

IF Frequencies:

1st 70.4515MHz

2nd 9.0115MHz

3rd 455KHz

4th 9.0115MHz (except F₃*)

with continuous Bandwidth Control (except F₃*)

2nd IF Center Frequency:

SSB (A₃J) AM (A₃) 9.0115MHz

CW (A₁) RTTY (F₁) 9.0106MHz

FM* (F₃) 9.0100MHz

Sensitivity (when preamplifier is ON):

SSB, CW, RTTY

Less than 0.15 microvolts (0.1 ~ 1.6MHz : 1 microvolt) for 10dB S+N/N

AM Less than 0.5 microvolts (0.1 ~ 1.6MHz : 3 microvolts)

FM* Less than 0.3 microvolts for 12dB SINAD (1.6 ~ 30MHz)

Selectivity:

SSB, CW, RTTY 2.3KHz at -6dB
(Adjustable to 500Hz min)

4.2KHz at -60dB

CW-N, RTTY-N 500Hz at -6dB

1.5KHz at -60dB

AM 6KHz at -6dB

(Adjustable to 2.7KHz min)

15KHz at -50dB

FM* 15KHz at -6dB

25KHz at -60dB

Spurious Response Rejection Ratio:

More than 60dB

Audio Output:

More than 3 Watts

Audio Output Impedance:

8 ohms

*When optional FM unit is installed.

Specifications are approximate and are subject to change without notice or obligation.

SECTION 2 FEATURES

GENERAL COVERAGE RECEIVER CAPABILITY

The IC-R71 is a general coverage receiver between 100KHz and 30MHz with thirty 1MHz segments. The Up-conversion system using a high side IF and Microcomputer Control System make these capabilities possible.

In addition to these, the low-pass filters and the band-pass filters selected by an electronic signal from the BAND UP/DOWN button, make a no tune-up system.

DUAL 10Hz STEP DIGITAL VFO

The dual digital VFO consists of the PLL unit, which has a dual looped Phase-Locked-Loop, and the LOGIC unit used to control the PLL, has the Microcomputer Control System.

Normal tuning rate is in 10Hz increments and increasing the speed of rotation of the main tuning knob shifts the tuning to 50Hz increments automatically. Pushing the tuning speed button gives 1KHz tuning. Digital outputs are available (as an option) for computer control of the receiver frequency and functions, and for a synthesized voice frequency readout.

10-KEY KEY PAD

10-KEY key pad is provided in order to set a desired frequency easily and faster. By pushing digit keys in order of the desired frequency digits, the operating frequency will be changed without changing the band and turning the tuning control.

32 MEMORIES

Thirty two tunable memories are provided to store mode and frequency, and the internal RAM is backed up by an internal lithium memory backup battery to maintain the memories for up to seven years. Scanning of frequencies, memories and bands are possible from the unit. In the Mode-S mode, only those memories with a particular mode are scanned; others are bypassed. Data may be transferred between VFO's, from VFO to memories, or from memories to VFO.

OUTSTANDING RECEIVER PERFORMANCE

Utilizing an ICOM developed J-FET DBM, the IC-R71 has a 105dB dynamic range. The 70.4515MHz first IF virtually eliminates spurious responses, and a high gain 9.0115MHz second IF, with ICOM's PBT selectivity. A deep IF notch filter, adjustable AGC and noise blanker (can be adjusted to eliminate the woodpecker noise), audio tone control, clear reception even in the presence of strong QRM or high noise levels. A low noise receiver preamp provides exceptional reception sensitivity as required.

PASS-BAND TUNING

The IC-R71 has a built-in Pass-Band Tuning system developed by ICOM that allows you to continuously adjust the pass band of the IF. By turning the control, you can eliminate interference from a nearby signal, thus providing clear reception.

SECTION 3 INSTALLATION

BE SURE TO READ THE FOLLOWING INSTRUCTIONS BEFORE USE.

3-1 UNPACKING

Carefully remove your receiver from the packing carton and examine it for signs of shipping damage. Should any be apparent, notify the delivering carrier or dealer immediately, stating the full extent of the damage. It is recommended you to keep the shipping cartons. In the event storage, moving, or reshipment becomes necessary they will be handy. Accessory cables, plugs, etc., are packed with the receiver. Make sure you have not overlooked anything.

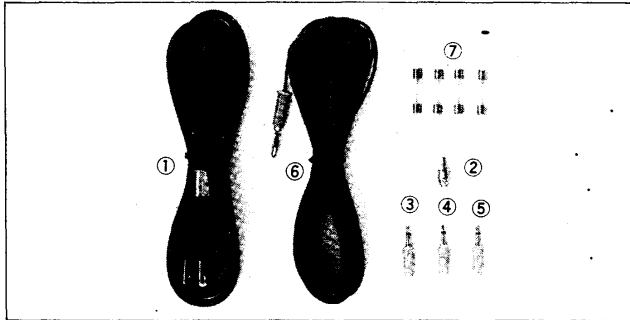

| | |
|---------------------------------|-----|
| 1. AC Power Cord | 1 |
| 2. Pin Plug | 1 |
| 3. External Speaker Plug | 1 |
| 4. Recorder Plug | 1 |
| 5. Recorder Remote Control Plug | 1 |
| 6. Antenna Wire | 10m |
| 7. Spare Fuses | 4 |

3-2 RECOMMENDATIONS FOR INSTALLATION

1. Avoid placing the IC-R71 in direct sunlight, high temperature, dusty or humid places.
2. Be sure that nothing is on and just behind the rear panel to ensure good ventilation. Also avoid places near outlets of heaters, air conditioners, etc.
3. Place the unit so that the controls and switches can easily be handled and the frequency indication and meter can easily be read.
4. Use the Ground Lug!

3-3 POWER SUPPLY

The receiver has a built-in AC power supply. Connect the supplied AC power cord to the AC power socket on the rear panel of the unit, and the opposite side plug of the power cord into any convenient AC power outlet.

When you wish to use the receiver with an AC power supply voltage other than the original one, you must make internal wiring modifications as per the following drawings.

If you are not familiar with soldering or do not understand the drawings, don't attempt to make any modifications, but contact the nearest ICOM service center or authorized dealer.

For 100V AC

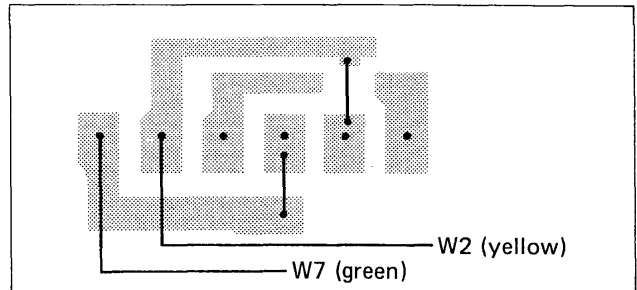

For 117V AC

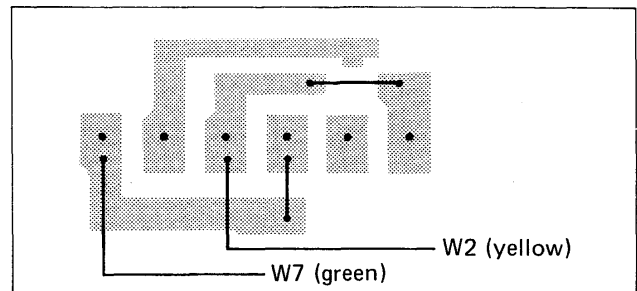

For 200V AC

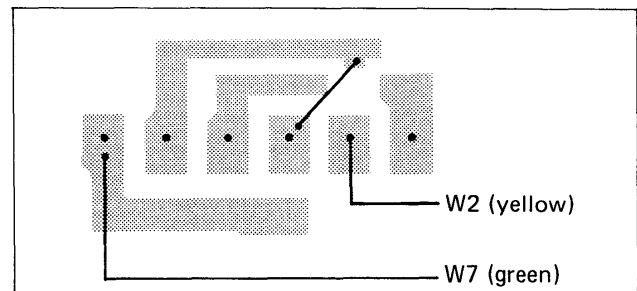

For 220V AC

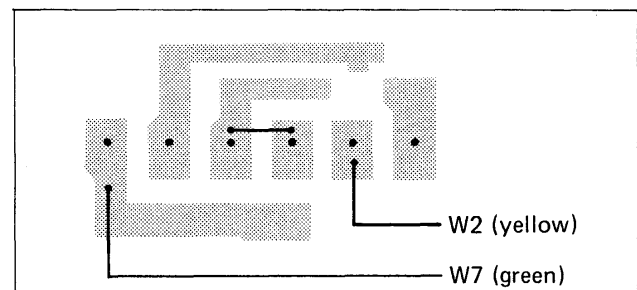

For 235V AC

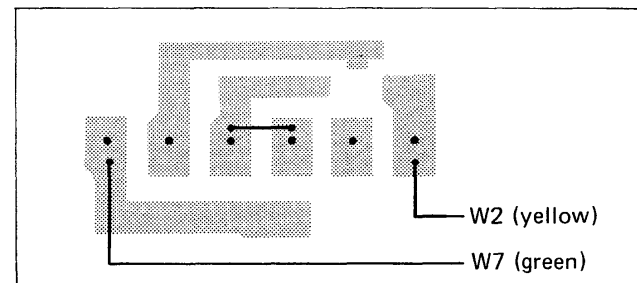

NOTE: For DC operation, contact your nearest ICOM service center or authorized ICOM dealer.

3-4 ANTENNA

The antenna plays a very important role in radio communication. If the antenna is inferior, your receiver cannot give you the best performance. With a good antenna and feeder cable having 50 ohms impedance, you should easily get the desired matching and performance. Carefully install a high performance antenna that suits the frequency band(s) you wish to operate on and place it as high as possible. Be especially careful of the condition of the connectors as loose connections will deteriorate the performance.

Since the IC-R71 is a general coverage receiver it is recommended that a long-wire general coverage antenna and an antenna coupler be used. To attempt to use a Ham band antenna for general coverage reception could result in mismatching, and attendant poor reception. However, it is good enough for strong broadcasting stations. Also, the supplied antenna wire can be used as a temporary antenna.

Example of various antennas:

• Long Wire Antenna

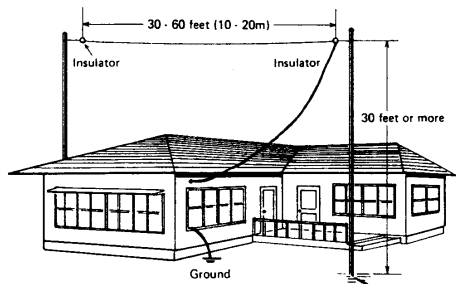

• Dipole Antenna

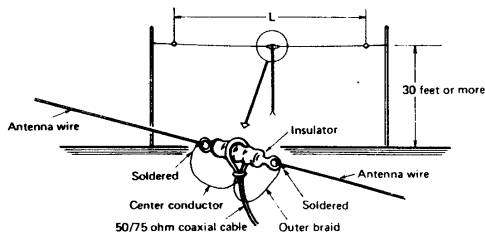

$$L(m) = \frac{143}{\text{Frequency (MHz)}} \quad \text{or} \quad L(\text{feet}) = \frac{468}{\text{Frequency (MHz)}}$$

• Multiband Antenna

L1, L2 and L3 can be calculated by the same formula as for dipole antenna.

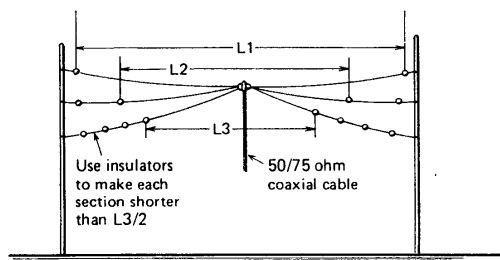

3-5 GROUND

In order to prevent electrical shocks, and other problems, be sure to connect a heavy wire ground, as short as possible, from a good earth point to the ground terminal on the rear panel.

Example of various ground systems:

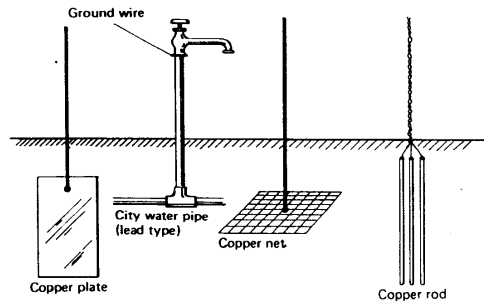

3-6 EXTERNAL SPEAKER

The IC-R71 contains an internal speaker, and is also designed so that it can drive an external speaker from the external (EXT) speaker jack on the rear panel. Be sure the impedance of the external speaker is 8 ohms, and remember that with the external speaker connected, the internal speaker is disabled.

3-7 HEADPHONES

Any good headphone set, including stereo type, that have 4-16 ohms impedance can be used. With the plug inserted halfway into the PHONES jack, both the headphone and speaker will operate. This is convenient when others wish to listen in on the station.

With a stereo headphone set inserted this way, however, the headphone will lose the sound on one side. With the plug inserted completely, only the headphone works.

3-8 CAUTIONS

As the unit has already been closely adjusted with highly sophisticated measuring instruments, never tamper with the turnable resistors, coils, trimmers, etc.

C-MOS is used in the Logic unit as well as the PLL. C-MOS ICs are very susceptible to excessive static charges and over-current and care must be used when handling them. Therefore, avoid touching the Logic unit and the nearby circuitry unless absolutely necessary. When it is necessary to check the circuitry, observe the following points.

Ground all measuring instruments, the soldering iron, and other tools. Do not connect or disconnect the C-MOS IC from its socket, or solder it when the power is on. Do not apply voltage of less than -0.5 or more than +5 Volts to the input terminals of the IC. DO NOT MEASURE WITH AN OHMMETER.

SECTION 4 OPERATING CONTROLS

4 - 1 FRONT PANEL

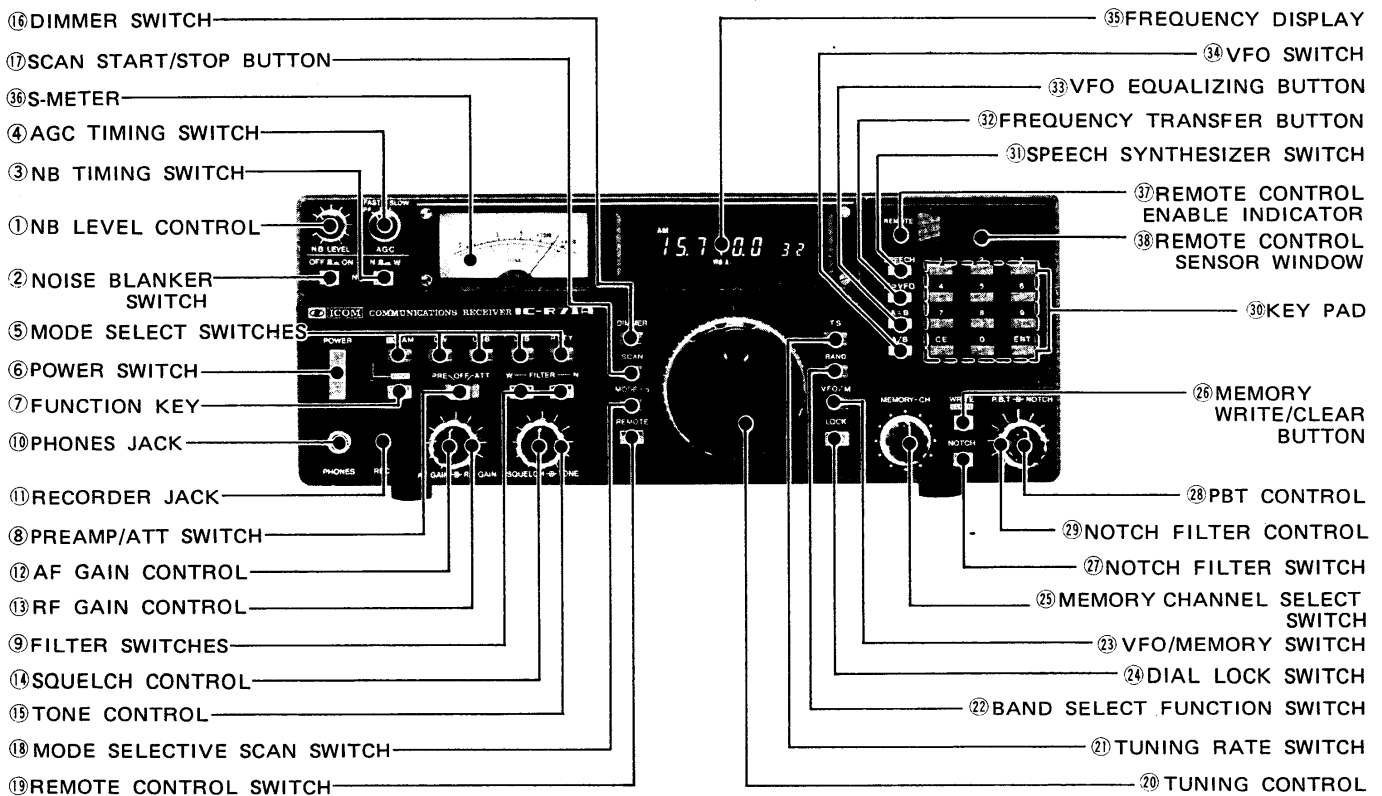

1. NB LEVEL CONTROL

Controls the threshold level of the noise blanker. Adjust the controls so that incoming noises will be disappeared.

2. NB (NOISE BLANKER) SWITCH

When pulse type noise such as automobile ignition noise is present, push this switch in. The noise will be reduced to provide comfortable reception.

3. NB TIMING SWITCH

The noise blanker blanking time can be selected NORMAL and WIDE by this switch. It will be effective against any types of noises.

4. AGC TIMING SWITCH

For changing the time-constant of the AGC (Automatic Gain Control) circuit. By setting the switch to slow position, the AGC voltage is released more slowly. Set the switch to provide comfortable reception.

When the switch is in the OFF position, the AGC function is turned OFF and the S-meter does not swing even if a signal has been received. (The AGC does not actuate on the FM mode.)

5. MODE SELECT SWITCHES

Selects any one of five operating modes by simply pushing the desired switch. Additionally, the AM switch has dual function as follows.

1. AM For AM operation.
2. FM Pushing the FUNCTION KEY first, then the AM switch, the FM mode is selected.

6. POWER SWITCH

This switch is a push-lock type switch which controls the input AC power to the set. When the switch is pushed in and locked, power is supplied to the set. The switch is pushed again and released, the power to all circuits is cut.

7. FUNCTION KEY

Increases the function of the AM MODE SELECT and the MEMORY WRITE switches by pushing this key switch first.

8. PREAMP/ATT (Attenuator) SWITCH

Switches RF preamplifier and attenuator in the RF circuit.

When the switch is in the OFF position, both preamplifier and attenuator are removed from the circuit, and incoming signals will be fed to the receiver directly.

When using a small antenna or receiving a weak signal, set the switch in the "PRE" position, and the preamplifier is put in the RF circuit and provides higher sensitivity.

When nearby signals interfere with reception, or receiving a very strong signal, set this switch in the "ATT" position. This removes the preamplifier from the circuit and inserts the attenuator into the circuit. This gives about 20dB attenuation.

For normal operation leave this switch in the "OFF" position.

9. FILTER SWITCH

Selects one of the second IF (9MHz) filters to improve the selectivity.

10. PHONES JACK

Accepts a standard 1/4 inch headphone plug for headphones of 4 ~ 16 ohms. Stereo phones can be used without modification.

11. RECORDER JACK

Accepts a 3.5mm mini plug for a tape recorder to record receiving signals. The output is a certain level regardless of the position of the AF GAIN control.

12. AF GAIN CONTROL

Controls the audio output level. Clockwise rotation increases the level.

13. RF GAIN CONTROL

Controls the gain of the RF section. Clockwise rotation gives the maximum gain. As the control is rotated counterclockwise, the needle of the METER rises, and only signals stronger than the level indicated by the needle will be heard.

14. SQUELCH CONTROL

Sets the squelch threshold level. To turn OFF the squelch function, rotate this control completely counterclockwise. To set the threshold level higher, rotate the control clockwise.

15. TONE CONTROL

Controls the receiver audio tone. Adjust the control to provide comfortable reception.

16. DIMMER SWITCH

By pushing this switch in, the intensity of the meter illumination and frequency display is reduced. Use this in the dark to prevent glare.

17. SCAN START/STOP BUTTON

Starts and stops any of the scan functions. When depressing it again to restart the scan, it will start from the stopped frequency in the programmed scan, or from the highest memory channel in memory scan.

18. MODE SELECTIVE SCAN SWITCH

When this switch is pushed, only memory channels stored with the operating mode which is displayed on the frequency display just prior to pushing this switch, are selected by turning the tuning control or scanning.

19. REMOTE CONTROL SWITCH

Switches the optical remote controller circuit (option). When this switch is pushed in and locked, the remote controller circuit will be turned on and the REMOTE CONTROL ENABLE INDICATOR will be lit.

20. TUNING CONTROL

Rotating this control clockwise increases the frequency or the memory channel number, while rotating it counterclockwise decreases it. The frequency changes by 10Hz in any mode. In 10Hz step tuning rate, by turning the tuning control faster, the 50Hz step tuning rate is automatically selected. This makes it very convenient to change frequency quickly over a wide range.

This control is also used to select the operating band while the BAND SELECT FUNCTION switch is depressed.

21. TUNING RATE SWITCH

By pushing in this switch, the operating frequency is changed to correspond to 1KHz increments in any mode.

At the same time, the 100Hz digit on the display is cleared to show "0". When this switch is pushed again and released, the frequency is changed normally. This switch allows you to quickly change over a great frequency range.

22. BAND SELECT FUNCTION SWITCH

By pushing in this switch, the operating band is changed by turning the TUNING CONTROL.

The operating frequency is changed in 1MHz steps but the lower digits do not change.

23. VFO/MEMORY SWITCH

Switches between VFO operation and MEMORY CHANNEL operation.

24. DIAL LOCK SWITCH

After the IC-R71 is set to a certain frequency by pushing the DIAL LOCK switch, the VFO is electronically locked at

the displayed frequency, thus inactivating the operation of the tuning knob. To change frequency, the dial lock must first be disengaged by pushing and releasing the DIAL LOCK switch again.

25. MEMORY CHANNEL SELECT SWITCH

Selects any one of 32 memory channels in the MEMORY CHANNEL operation. The selected channel number is displayed on the frequency display. By turning the switch clockwise the channel number is increased and counter-clockwise decreased.

26. MEMORY WRITE/CLEAR BUTTON

By pushing this button, a displayed frequency and selected mode are stored into a memory channel which is selected by the MEMORY CHANNEL SELECT switch.

By pushing the FUNCTION KEY first then this button, the secondary function is selected and the memorized frequency and mode in the displayed memory channel will be cleared.

27. NOTCH FILTER SWITCH

Switches the notch filter function ON and OFF.

28. P.B. TUNE (PASS BAND TUNING) CONTROL

Allows continuous tuning of the pass-band selectivity by moving the filter up to 800Hz from the upper or lower side in SSB, CW and RTTY. Not only improves selectivity, but also can improve the audio tone. Normal position is in the center (12 o'clock) position and is 2.3KHz wide in SSB.

29. NOTCH FILTER CONTROL

Shifts the notch filter frequency. Adjust the control so that the interference is reduced.

30. KEY PAD

There are ten numerical keys, and the canceling and entering keys for setting an operating frequency.

31. SPEECH SYNTHESIZER SWITCH

When the optional speech synthesizer unit is installed, this switch turns on the unit which announces the displayed frequency in English.

32. FREQUENCY TRANSFER BUTTON

In the VFO operation, the frequency and mode stored in a memory channel (displayed its channel number on the frequency display), are transferred to the selected VFO.

33. VFO EQUALIZING BUTTON

Instantly sets the frequency and mode of a VFO to the same as those of the other VFO.

34. VFO SWITCH

Selects either VFO, "A" or "B", for tuning. Each push of this button selects VFO A and B alternately.

35. FREQUENCY DISPLAY

The frequency of the IC-R71 is displayed on a luminescent display tube. Since the 1MHz and 1KHz decimal points are displayed, the frequency can easily be read. The frequency indicated is the carrier frequency of each mode in, USB, LSB, CW, AM and FM, and the mark frequency in RTTY.

The FREQUENCY DISPLAY shows not only the operating frequency but also mode, selected VFO or memory channel, and SCAN mode.

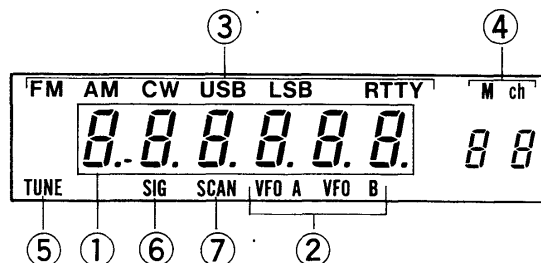

- ① Shows operating frequency in 6 digits between 10MHz and 100Hz.
- ② Shows selected VFO; VFO A or VFO B.
- ③ Shows operating mode; one of FM, AM, CW, USB, LSB, and RTTY.
- ④ Shows that the set is in the MEMORY CHANNEL MODE or not, and the selected memory channel number. When the set is in the MEMORY CHANNEL MODE, the letters "M ch" are displayed here.
- ⑤ Shows that the set is tuned to an incoming signal frequency within 1KHz on the FM mode. At this time, the letters "TUNE" are displayed here. (When optional FM unit is installed.)
- ⑥ Shows that the squelch is opened. When the squelch is opened, the letters "SIG" are displayed here.
- ⑦ Shows that the set is in the SCAN mode. When the set is in the SCAN mode, the letters "SCAN" are displayed here.

36. S-METER

Signal strength of an incoming signal is indicated on a scale of S1 ~ S9 and S9 to S9+40dB, and a linear scale divided into five.

37. REMOTE CONTROL ENABLE INDICATOR

Illuminates when the REMOTE CONTROL SWITCH is pushed in.

38. REMOTE CONTROL SENSOR WINDOW

An infrared sensor is installed under this window. This sensor detects infrared rays emitted from the optical remote controller to control operating frequency, mode, audio volume, speech synthesizer, etc.

4 - 2 REAR PANEL

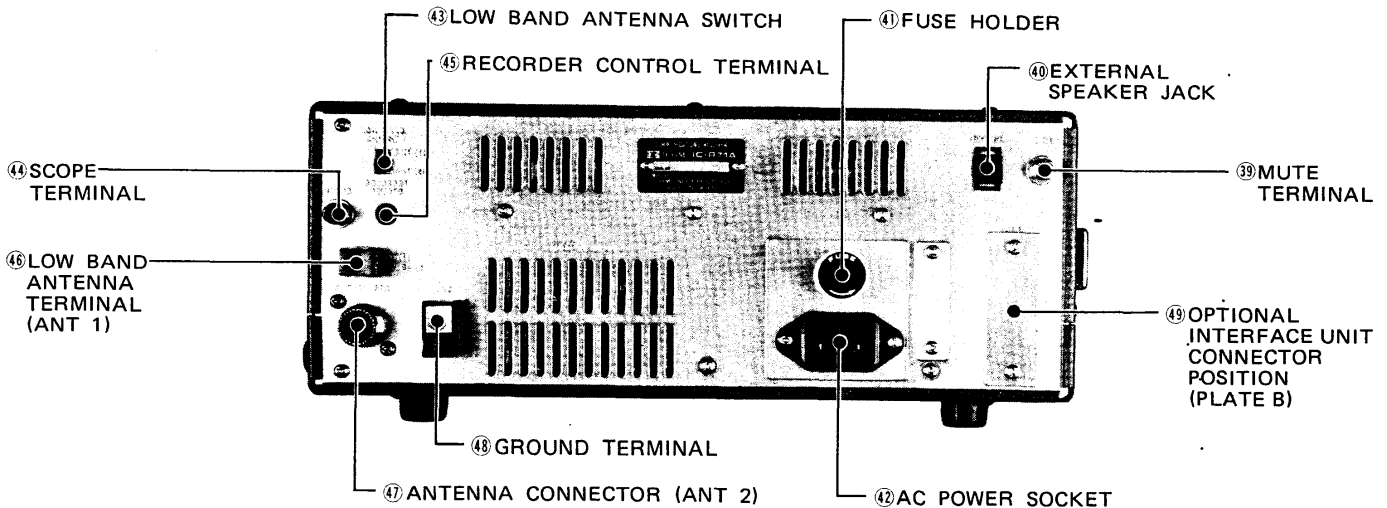

39. MUTE TERMINAL

When you wish to use the set together with a transmitter or transceiver, ground this terminal in the transmit mode, and the set is muted.

40. EXTERNAL SPEAKER JACK

When an external speaker is used, connect it to this jack. Use a speaker with an impedance of 8 ohms. When the external speaker is connected, the built-in speaker does not function.

41. FUSE HOLDER

This holds a fuse for the AC power circuit. If the fuse is blown, replace it with a new 1 Amp fuse for 100/117V operation, or 0.5 Amp fuse for 200/220/235V operation after checking the cause. Open the fuse holder with a Philips head screwdriver.

42. AC POWER SOCKET

For connection of the supplied AC power cable.

43. LOW BAND ANTENNA SWITCH

Switches the low band (1600KHz and below) antenna terminals; ANT 1 (46 LOW BAND ANTENNA TERMINAL) for a high impedance antenna such as a long wire antenna, and ANT 2 (47 50 ohm ANTENNA CONNECTOR) for a 50 ohm coaxial cable.

44. SCOPE TERMINAL

This terminal brings out the 70.4515MHz IF signal from the mixer in the receiver. Not only observes of the received

signal, but also these signals of a selected band width are possible by using a panadaptor or panascope.

45. RECORDER CONTROL TERMINAL

This terminal is grounded when the squelch is opened. This can be used to controlled a tape recorder so that the recorder works only when the squelch is opened and a signal is received.

46. LOW BAND ANTENNA TERMINAL (ANT 1)

For connection of a low band antenna to receive 1600KHz and below. When operating frequency goes to 1600KHz and below, the antenna terminal will be changed from 47 ANTENNA connector to this terminal automatically. (When the 43 LOW BAND ANTENNA SWITCH is set at the ANT 1 position).

47. ANTENNA CONNECTOR (ANT 2)

This is used to connect the antenna to the set. Its impedance is 50 ohms and connects with a PL-259 connector.

48. GROUND TERMINAL

To prevent electrical shock, and other problems, be sure to ground the equipment through the GROUND TERMINAL. For best results use as heavy a gauge wire or strap as possible and make the connection as short as possible.

49. OPTIONAL INTERFACE UNIT CONNECTOR POSITION (PLATE B)

This position is provided to install the connector of the optional interface unit.

SECTION 5 OPERATING INSTRUCTIONS

5-1 HOW TO TUNE

The following instructions are for tuning in any mode. Please read carefully and understand fully before turning ON your unit. Proper tuning is necessary for optimum operation.

5-1-1 PRESET

When the power switch is turned ON, the frequency display shows frequency and mode stored in the VFO A, letters "VFO A" and "01" representing memory channel 1, and the set operates with the VFO A and displayed mode, even if the previous operating mode was different.

FOR EXAMPLE

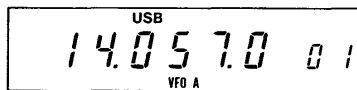

5-1-2 BAND SWITCHING

To change the operating band, push the BAND SELECT FUNCTION switch in and rotate the TUNING CONTROL.

By turning the TUNING CONTROL clockwise, the operating frequency changes 1MHz at a time. (100KHz and lower digits of the frequency will remain as it had in the previous one.) By turning the TUNING CONTROL counterclockwise, the operating frequency lowers 1MHz at a time from the previous one.

When the band reaches to the highest one, it will automatically return to the lowest one, or vice versa, as per the following charts.

| | |
|----------------|--------------|
| DOWN: 15.123.4 | UP: 15.123.4 |
| ↓ | ↓ |
| 14.123.4 | 16.123.4 |
| ↓ | ↓ |
| 13.123.4 | 17.123.4 |
| ⋮ | ⋮ |
| ↓ | ↓ |
| 1.123.4 | 29.123.4 |
| ↓ | ↓ |
| 0.123.4 | 0.123.4 |
| ↓ | ↓ |
| 29.123.4 | 1.123.4 |
| ⋮ | ⋮ |
| ↓ | ↓ |
| 00.123.4 | 29.123.4 |

With the BAND SELECT FUNCTION switch is out, when the operating frequency reaches the highest or lowest edge, of the MHz range by turning the TUNING CONTROL continuously, the operating frequency will go to the next MHz range.

5-1-3 FREQUENCY DISPLAY ON EACH MODE

When the 7MHz band and AM are selected, the display will be as follow:



When changing to other modes, the display will be as follows:

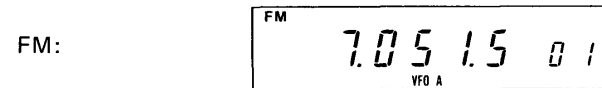
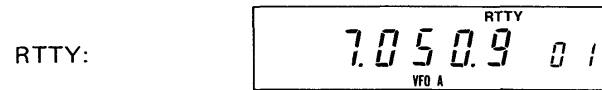
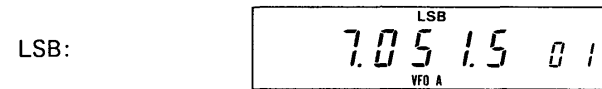
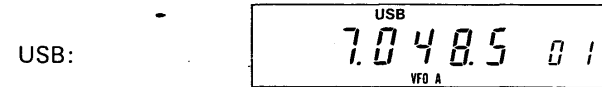
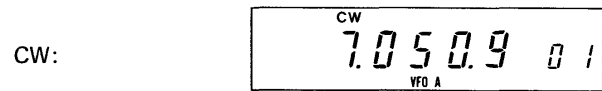

The displayed frequency shows the carrier frequency. To avoid the trouble of recalibrating the dial when you change the operating mode, the displayed frequency is set to shift to the carrier frequency of each mode automatically. For the differences of frequency shifts of the various modes, refer to the following figure.

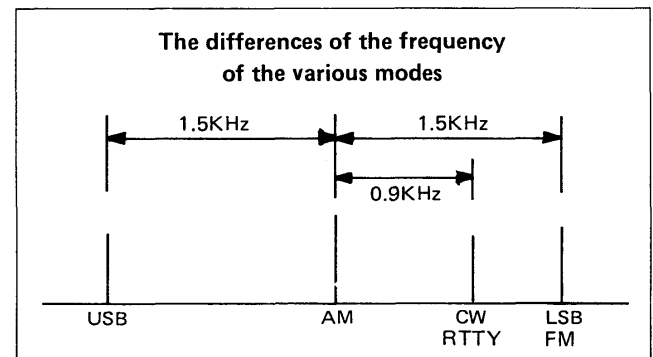

5-1-4 TUNING CONTROL

Rotating the TUNING CONTROL clockwise increases the frequency, while turning counterclockwise decreases the frequency in 10Hz steps. By turning the tuning control faster, the 50Hz steps tuning rate is automatically selected.

When the TUNING RATE switch is pushed in, the 1KHz steps tuning rate is selected in any mode. At this time, the 100Hz digit of the frequency display is cleared to "0".

By turning the TUNING CONTROL clockwise, the operating frequency reaches the highest one of that MHz range

(for example; 14.999.9MHz), and further turning of the control brings the frequency to the next upper MHz range (15.000.0MHz) and continues up the frequency from there. By turning the control counterclockwise, the operating frequency changes in like manner to the next lower MHz range.

Brake Adjustment

If the control is too loose or too stiff for comfortable use, you can adjust the torque by tightening or loosening the brake adjustment screw accessible from underneath the set.

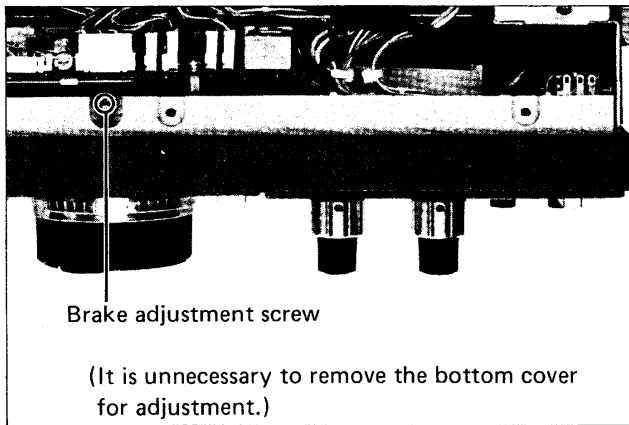

The following instructions should be used to adjust the tension of the Tuning control.

1. The Tuning control tension will become tighter by turning the brake adjustment screw clockwise, and will become looser by turning the screw counterclockwise.
2. While performing this adjustment, the Tuning control must be turned continuously as the screw is adjusted in order to set the tension for a comfortable touch.

5 - 1 - 5 DIAL LOCK SWITCH

After the IC-R71 is set at a certain frequency by pushing the Dial Lock switch, the VFO is locked at the displayed frequency, thus inactivating the operation of the tuning control. To change the frequency, the Dial Lock must first be disengaged by pushing and releasing the Dial Lock switch again.

5 - 1 - 6 VFO SWITCH

NOTE: When the letters "VFO A" or "VFO B" are displayed on the frequency display, we call this condition as "VFO MODE", when the letters "M ch" are displayed above the memory channel number, we call as "MEMORY CHANNEL MODE".

These can be changed by pushing the VFO/MEMORY switch alternately.

The IC-R71 contains two VFO's. The VFO's are labeled "VFO A" and "VFO B", and are selectable by pushing the VFO switch alternately in the VFO MODE. The dual VFO system gives the IC-R71 many very convenient features. Please read this section very carefully and perform the operation several times until you are comfortable with the system. Try the example for practice!

1. VFO "A" is selected by placing the VFO switch in the "A" position. The receive frequency will be controlled by VFO "A", displayed on the frequency readout, and stored in "A" memory.
2. VFO "B" is selected by placing the VFO switch in the "B" position. The receive frequency will be controlled by VFO "B", displayed on the frequency readout, and stored in "B" memory.

Switching from one VFO to the other VFO does not clear the first VFO. The frequency and operating mode are retained in the VFO's memory.

FOR EXAMPLE:

If 14.252MHz and USB are set with the "VFO A", then the VFO switch is pushed to select the "VFO B", the frequency display will show VFO B's frequency and mode, but 14.257MHz and USB are still stored in the VFO A's memory.

Pushing the VFO switch again to return to the VFO A, "14.257.0" and "USB" will be displayed on the frequency display.

Accordingly, if the VFO switch is pushed again to the VFO B, the frequency and mode that were set with the VFO B will appear.

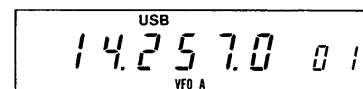

Pushing the VFO switch to select the VFO B.

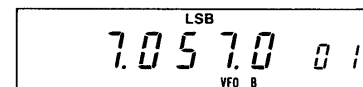
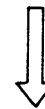

Pushing the VFO switch again to return the VFO A.

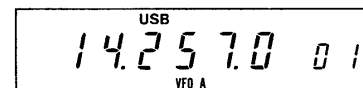

This allows you to set a certain frequency with one VFO, work up and down the band with the other VFO, and periodically check the set frequency simply by switching between VFO "A" and "B".

5 - 1 - 7 TRANSFERRING VFO FREQUENCY

The VFO EQUALIZING switch allows either VFO's to be brought to the exact frequency and operating mode of the other VFO without turning the tuning control and pushing the mode select switch.

FOR EXAMPLE:

When VFO A is 14.271MHz and USB, and VFO B is 29.670MHz and FM, pushing the VFO switch to select VFO A, then the VFO EQUALIZING switch, VFO B's frequency and operating mode become the same as VFO A's (14.271MHz and USB). Now the VFO A's frequency is memorized in the VFO B, and you can operate anywhere with VFO A or B. When you want to return to the previous frequency (14.271MHz), switch back to the other VFO. To reverse this (A the same as B), select VFO B first, then the VFO EQUALIZING switch.

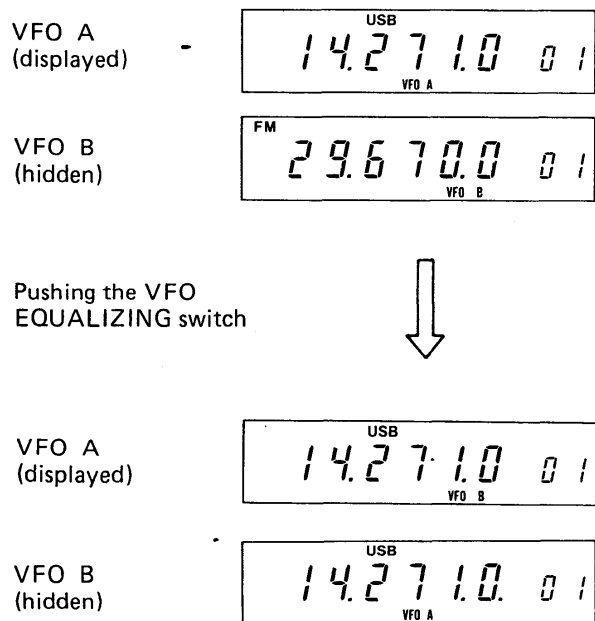

5-2 MEMORY CHANNEL OPERATION

5-2-1 MEMORY CHANNEL SELECTION

When the power switch is turned ON, the set initially operates with the VFO A and memory channel number "01" is displayed. By pushing the VFO/MEMORY switch, the set is switched into the MEMORY CHANNEL MODE and frequency and mode which have been stored in the "MEMORY CHANNEL 1" are displayed on the frequency display. In addition, the letters "M ch" are also displayed above the memory channel number to indicate the set is in the MEMORY CHANNEL MODE.

FOR EXAMPLE:

When "14.271MHz" and USB are memorized in VFO A, and "29.625MHz" and FM are in MEMORY CHANNEL 1, by pushing the power switch ON, the frequency display shows "14.271.0", "USB", "VFO A" and memory channel number "01".

By pushing the VFO/MEMORY switch, the display will show "29.625.0" and "FM", memory channel number "01", and the letters "M ch" above the channel number.

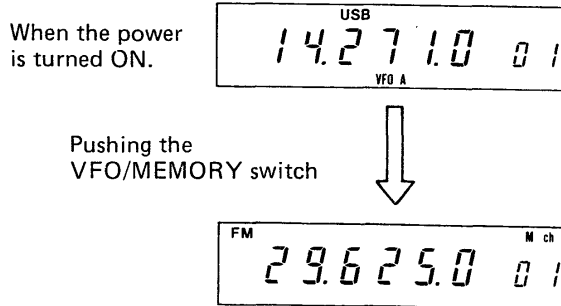

By turning the MEMORY CHANNEL SELECT SWITCH, memory channels can be selected. Turning clockwise increases the channel number and counterclockwise decreases the number, and the respective frequency and mode are displayed on the display.

When you select a memory channel that has never had any frequency stored in it, the frequency display does not show any frequency, but MHz and KHz decimals. However, the set works with the frequency and mode of the memory channel (or VFO), which was previously displayed.

FOR EXAMPLE:

When "7.012MHz" and "CW" are memorized in memory channel 2, and no frequency is in channel 3, by turning the MEMORY CHANNEL SELECT switch clockwise, the frequency display will show "7.012.0" "CW", "M ch" and memory channel number "02".

By turning the MEMORY CHANNEL SELECT switch clockwise furthermore, the memory channel number will change to "03", but the channel has never memorized any frequency, thus the display shows "CW" and only the MHz and KHz decimals. However, the set works with the frequency and mode of channel 2, i.e., "7.012MHz" and "CW".

When memory channel limits are reached (i.e., "01" or "32"), the next memory channel entered will be the opposite limit (i.e., "32" or "01").

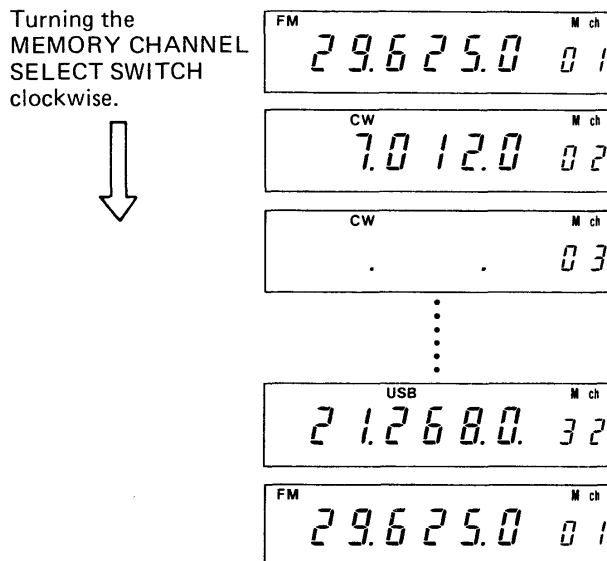

In the MEMORY CHANNEL MODE, by turning the TUNING CONTROL, the OPERATING FREQUENCY displayed on the frequency display can be changed. This is very convenient for tuning a slightly off frequency or to change the operating frequency, or to rewrite the memorized frequency in the selected memory channel.

FOR EXAMPLE:

Now you are operating on 14.271MHz and USB with memory channel 7. By turning the TUNING CONTROL clockwise increases the frequency and counterclockwise decreases one, the same as a VFO.

To tune to "14.295MHz", turn the TUNING CONTROL clockwise to obtain the desired frequency "14.295.0" on the display.

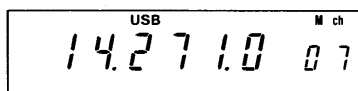

Turning the TUNING CONTROL.

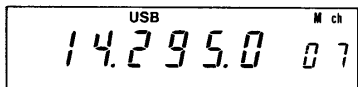

If you wish to transfer this operating frequency (14.295 MHz) and mode (USB) into a VFO, push the FREQUENCY TRANSFER (M → VFO) button, and the operating frequency "14.295MHz" and mode "USB" are transferred into the VFO previously selected.

NOTE: Don't push the VFO/MEMORY switch before pushing the FREQUENCY TRANSFER button to transfer the operating frequency (at this time, 14.295MHz), or the operating frequency is erased and the original memorized frequency (14.271 MHz) will be transferred into the VFO.

If you wish to rewrite the memorized frequency in the selected channel (at this time, "07") to this frequency ("14.295.0"), push the MEMORY WRITE button, and the operating frequency "14.295MHz" and mode "USB" are memorized into the memory channel 7.

To change the operating memory channel again, turn the MEMORY CHANNEL SELECT SWITCH.

5 - 2 - 2 MEMORY-WRITE (PROGRAMMING THE MEMORY CHANNELS)

Any operating frequency and mode can be memorized into a memory channel.

1. Set the operating frequency and mode to desired ones

by a VFO. For example, set them for "15.725MHz" and "AM" by using VFO B.

2. Select a memory channel to be memorized by turning the MEMORY CHANNEL SELECT SWITCH. For example, select memory channel 10.
3. To check the contents in the memory channel, push the VFO/MEMORY switch, and the contents are displayed on the frequency display. If you don't want to rewrite the contents, select another memory channel which has erasable contents or no memorized frequency. (When no frequency has been memorized, only the MHz and KHz decimals are displayed at the frequency position.) After checking, push the VFO/MEMORY switch again to return to the VFO.
4. One push of the MEMORY WRITE button erases the previous memorized contents (if any) and memorizes the displayed frequency and mode into the selected memory channel (at this time channel 10).
5. Memorize other desired frequencies and modes into memory channels in the same manner. Memory channel 1 and 2 are used also for the PROGRAMMED SCAN. For PROGRAMMED SCAN operation, refer to "SCANNING OPERATION" on page 13.

Frequency and mode to be memorized.

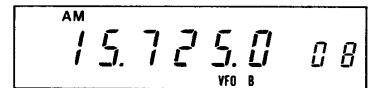

Turning the MEMORY CHANNEL SELECT SWITCH.

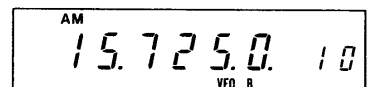

Pushing the VFO/MEMORY switch to check contents of the channel.

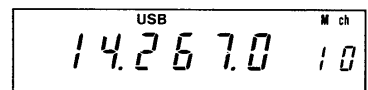

Pushing the VFO/MEMORY switch to return to the VFO, then pushing the MEMORY WRITE button.

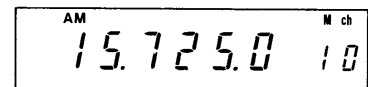

(This is displayed after pushing the VFO/MEMORY switch.)

5 - 2 - 3 MEMORY CLEARING

If you want to clear contents of a memory channel, the first, select the channel to be cleared, the second, push the FUNCTION KEY then the MEMORY WRITE button.

The contents of the channel will be cleared.

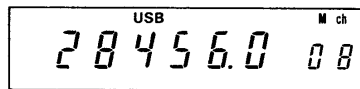

Pushing the FUNCTION KEY first, then the MEMORY WRITE button.

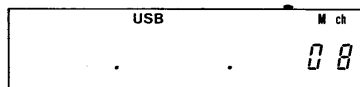

5 - 3 FREQUENCY SETTING BY KEY PAD

By pushing digit keys in order of the desired frequency digits, the frequency display will be changed accordingly. When the frequency display shows the desired frequency, push the "ENT" key and the operating frequency of the IC-R71 will be changed to the displayed one.

FOR EXAMPLE:

When desiring to set 21.234.5MHz, push digit keys as follows;

2 **1** **2** **3** **4** **5** **ENT**

If you pushed a wrong digit key (before pushing the "ENT" key), push the "CE" key, and the frequency display shows the previous frequency (operating frequency). Now you can set the desired frequency again.

When setting the desired frequency, push all digit keys in order down to the 100Hz digit, then the "ENT" key, except the desired frequency is exactly on a MHz (for example; 14.000.0MHz).

FOR EXAMPLE:

When desiring to set 14.000.0MHz, push digit keys as follows;

1 **4** **ENT**

When the desired frequency is lower than 1MHz, push "0" key first, then digit keys of the desired one.

FOR EXAMPLE:

When desiring to set 828KHz (0.828.0MHz), push digit keys as follows;

0 **8** **2** **8** **0** **ENT**

When the TUNING RATE SWITCH of the IC-R71 is turned ON, the 100Hz digit will be "0", even if another figure has been entered. So if you want to set a frequency that has a 100Hz digit other than "0", be sure to turn OFF the TUNING RATE SWITCH.

5 - 4 SCANNING OPERATION

The IC-R71 provides various scanning operations. Please read the following instructions carefully to fully enjoy the IC-R71's many capabilities.

5 - 4 - 1 MEMORY SCAN

This is used to scan all programmed memory channels continuously.

1. Program your desired frequencies into memory channels.
2. Select a memory channel programmed with a frequency. (The scan cannot start from a blank channel.)
3. Depress the SCAN START/STOP button, and the frequency starts scanning the programmed frequencies in the memory channels from the highest channel to the lowest. At this time, the scan skips blank channels, if any.
4. If the SQUELCH is engaged, the scan stops when the squelch is opened and a signal is received. The scan restarts after a specified delay time.

To stop scanning without opening the squelch, depress the SCAN START/STOP button. Depress it again to restart the scanning.

5 - 4 - 2 MODE SELECTIVE SCAN

In the memory scan mode, by pushing the MODE SELECTIVE SCAN switch in, the scan scans only on channels having the desired operating mode.

To be in this scan mode, first, select a channel that has your desired mode, second, push the MODE SELECTIVE switch in, then the SCAN START/STOP button.

When the set is scanning in the normal memory scan mode, push the MODE SELECTIVE switch in at the moment that your desired mode is displayed on the display.

5 - 4 - 3 PROGRAMMED SCAN

This is to scan between two desired frequencies, which are memorized in the memory channels "1" and "2".

1. Memorize the frequencies of the high and low edges of the desired scanning range into the memory channels 1 and 2. Regardless of which channel the higher frequency is memorized in, the scan starts from the high edge of the range.
For example, 14.200MHz is in the memory channel 1 and 14.300MHz in the channel 2.
2. Place the unit in the VFO MODE and select the operation mode the same as the channels 1 and 2, and either VFO. Pushing the SCAN START/STOP button starts the scan from the high edge (14.300MHz) to the low edge (14.200MHz). The scanning frequency increments depend on the TUNING RATE SELECT switch setting.

3. When the scanning frequency reaches the low edge (14.200MHz), it automatically returns to the high edge (14.300MHz) and continues scanning down to provide endless scanning operation.
4. While the SQUELCH is engaged, the squelch opens when a signal is received and will stop the scanning automatically on the frequency, and the signal can be monitored. After approximately 10 seconds, the scan restarts from the frequency the scan stopped at, continuing to the low edge.
If the "SIG" indicator on the frequency display is lit because the SQUELCH is not engaged, the scan does not stop at any signals.
5. Depressing the SCAN START/STOP button while the scan is operating or during the 10 seconds of monitoring, clears the scanning operation and the VFO goes back to normal operation.
6. By turning the set into the transmit mode, or rotating the TUNING CONTROL, or pushing the VFO switch, VFO/MEMORY switch, or one of the MODE SELECT switches the scan stops and clears.

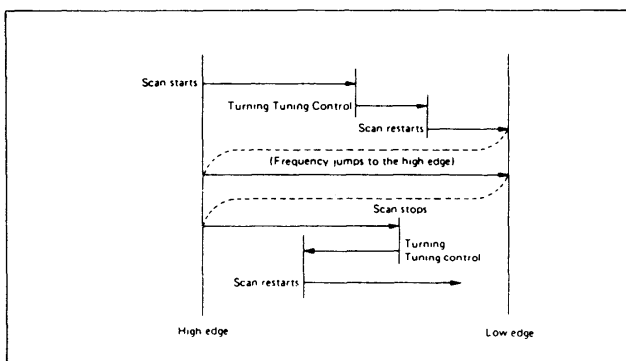

7. When the operating frequency is higher than the high edge (14.300MHz) and SCAN START/STOP button is pushed, the scan starts from the operating frequency and scan down to the low edge, but it will return to the memorized high edge frequency (14.300MHz) and continue the scanning to the low edge. If the operating frequency is below the low edge frequency (14.200MHz), the scan frequency jumps to the high edge frequency (14.300MHz) and starts from the high edge.

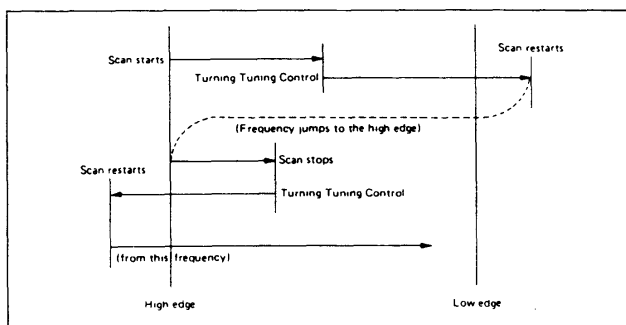

NOTE: The auto-stop functions with SSB or CW signals, but the scan does not always stop at the exact carrier frequency. When the scan stops on a signal, tune into the signal for better reception by pushing a MODE switch for the proper mode (if different) and by rotating the TUNING CONTROL.

5 - 4 - 4 RESUMING SCAN

All scan modes are provided with the resume scan function. When the scan has been stopped by the auto-stop function, the scan will restart after passing a specified time (about 10 seconds).

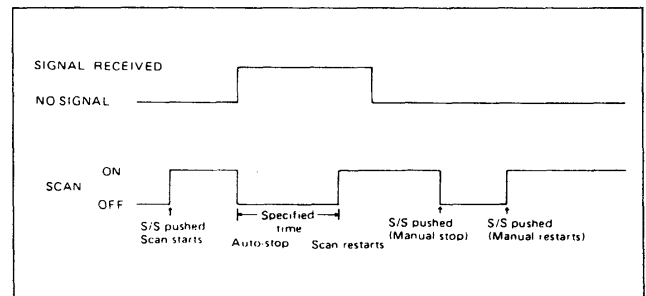

5 - 5 SSB OPERATION

5 - 5 - 1 RECEIVING

After connecting an antenna, AC power cord, etc., set knobs and switches as follows.

| | |
|---------------------------|--------------------------------|
| POWER SWITCH | OFF (OUT) |
| PREAMP/ATT SWITCH | OFF |
| AGC TIMING SWITCH | SLOW |
| NOISE BLANKER (NB) SWITCH | OFF (OUT) |
| VFO SWITCH | A (OUT) |
| AF GAIN CONTROL | Completely Counterclockwise |
| RF GAIN CONTROL | Completely Clockwise |
| FILTER SWITCHES | Normal (Both switches are OUT) |
| P.B. TUNE CONTROL | Center (12 o'clock) position |
| NOTCH FILTER SWITCH | OFF (OUT) |

Now push the POWER switch in. The meter lamp will be illuminated, after a few seconds, a frequency and mode memorized in the VFO A, and memory channel number "01" will be shown on the frequency display.

In SSB operation there is both a USB (upper side band) and an LSB (lower side band). In the HAM bands, LSB is usually used on the 1.8, 3.5 and 7MHz bands, while USB is usually used on the 10MHz band and above.

On the other bands, USB is usually used on any frequency.

When you wish to operate on another MHz band than the displayed one, push the BAND SELECT FUNCTION switch in, then turn the TUNING CONTROL so that the desired MHz band is displayed.

Slowly turn the AF GAIN control clockwise to a comfortable level. Rotate the tuning knob until a signal is received. The meter needle will move according to the signal strength, so tune for the highest possible meter reading and the clearest audio. If you cannot get a clear signal, you may be receiving in the opposite sideband. If so, change the mode to the proper sideband.

Adjust the RF GAIN control and TONE control for comfortable reception.

If squelch operation is required to cut out noise when no signal is received, turn the SQUELCH control clockwise until the noise from the speaker stops and leave it just below this threshold.

For tuning, memory channel operation and scanning operation, please refer to 5 - 1 HOW TO TUNE on page 9, 5 - 2 MEMORY CHANNEL OPERATION on page 11, 5 - 3 FREQUENCY SETTING BY KEY PAD on page 13 and 5 - 4 SCANNING OPERATION on page 13.

5 - 5 - 2 NB (NOISE BLANKER)

When there is pulse type noise, such as ignition noise from automobile motors, turn the NB LEVEL control clockwise and click ON, so that noise will be suppressed and even weak signals will be received comfortably.

When the NB switch is set in the WIDE (locked in) position, the noise blanker will effectively work for "woodpecker's noise", however, if the receiving signal is too strong, the noise blanker may work with the receiving signal itself, and some distortion may occur in the receiving audio or keying form. At this time, set the N.B. Switch in the out position, or turn the NB LEVEL control completely counterclockwise (Off position).

5 - 5 - 3 AGC (AUTOMATIC GAIN CONTROL)

The IC-R71 has a fast attack/slow release AGC system which holds the peak voltage of rectified IF signals from the IF amp circuit for a certain period. Therefore, during the pauses in normal speech of the receiving signal, uncomfortable noise will not be heard. The meter indicates the peak value for a certain period, facilitating reading of the meter "S" function.

For normal SSB reception, turn the AGC TIMING Switch to the SLOW position. Turn the AGC TIMING Switch to the FAST position, when tuning or receiving signals with short interval fading. When in the FAST position, the time constant is shortened.

When this switch is set at the OFF position, the AGC

circuit is turned OFF, and the S-meter does not work even if a signal is received. However the RF GAIN control is still active and the needle of the meter moves depending on the control position.

5 - 5 - 4 PREAMP/ATT SWITCH

Slide the PREAMP/ATT Switch to the PRE position when receiving weak signals. In the PRE position, an RF preamplifier is inserted into the receiving antenna circuit, increasing sensitivity and giving easy reception.

Slide the PREAMP/ATT switch to the ATT position when strong nearby signals disturb signal reception or make "S" reading difficult. In the ATT position, the RF amplifier is removed from the circuit and a 20dB attenuator is inserted into the receiving antenna circuit, reducing interfering signals and giving more stable reception. In normal operation the PREAMP/ATT switch is left in the OFF position.

5 - 5 - 5 FILTER SWITCHES

These switches select three conditions as follows;

NORMAL Both switches are OUT position or pushed in.

WIDE The W (wide) switch is pushed in.

NARROW The N (narrow) switch is pushed in.

A filter is selected in each condition. The selectivity and Pass-Band-Tuning function will be as follows;

| FILTER SWITCH | BAND WIDTH | PBT CONTROL |
|---------------|------------|-------------|
| NORMAL | 2.3KHz | EFFECTIVE |
| WIDE | 2.8KHz | INOPERATIVE |
| NARROW | 500Hz* | EFFECTIVE |

* When optional CW filter, FL-32 is installed.

5 - 5 - 6 P.B. (PASS-BAND) TUNING

Pass-Band Tuning is a system to narrow the band width (selectivity) of the frequencies that will pass through the crystal filter electronically from either the upper or lower side continuously by up to 500Hz. This is very effective in reducing interference from nearby signals.

To use the PBT system, rotate the PBT control clockwise or counterclockwise depending on the interfering signals. The center (12 o'clock) position is the widest position.

For example, while receiving in the LSB mode, if you get interference from a lower frequency (interfering signals are high-pitched tones), narrow the band width by turning the P.B. tuning control counterclockwise. When the interfering signals are low-pitched tones, they are from a higher frequency, and you should narrow the band width by

turning the P.B. tuning control clockwise.

When receiving in the USB mode, the band width is narrowed in the opposite manner. Interference from a higher frequency will be high-pitched tones, and the P.B. tuning control should be turned clockwise. Interference from a lower frequency will be low-pitched tones and the P.B. tuning control is turned counterclockwise.

This control can also be used for audio tone adjustment, so it may be set for the most comfortable reception.

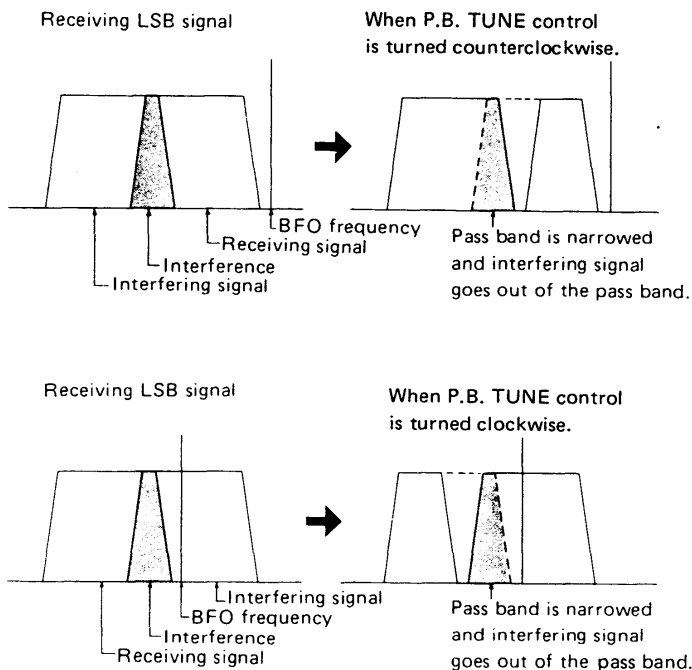

5-5-7 NOTCH FILTER

This circuit notches a frequency in the IF pass-band, so this is effective to reduce interference such as a beat-tone signal.

To use this function, push the NOTCH FILTER switch ON and turn the NOTCH FILTER control so that the interference is reduced.

5-6 CW OPERATION

For CW reception, push the MODE SELECT SWITCH for CW mode.

Other switches and knobs are set the same as for SSB reception.

When the optional CW filter, FL-32, is installed, by pushing the N (narrow) switch of the FILTER SWITCHES, the total selectivity of CW reception is improved to 500Hz at -6dB.

Also, with this filter, internal noise is reduced for comfortable CW reception and an improved signal to noise (S/N) ratio.

In addition, a narrower crystal filter, FL-63, is optional for this set. When you install this filter, the selectivity is improved to 250Hz at -6dB.

The Pass Band Tuning system can be used to narrow the band width up to 500Hz in CW mode the same as in the SSB mode.

Also, use the Noise Blanker, AGC switch, FILTER switches and/or PREAMP/ATT switch depending on the receiving conditions, the same as SSB reception.

5-7 RTTY OPERATION

For RTTY operation, a teletypewriter (or an equivalent) and a demodulator (terminal unit) which is operational with audio input are required. Any demodulator with 2125/2295Hz filters (narrow, 170Hz shift) can be used with the IC-R71.

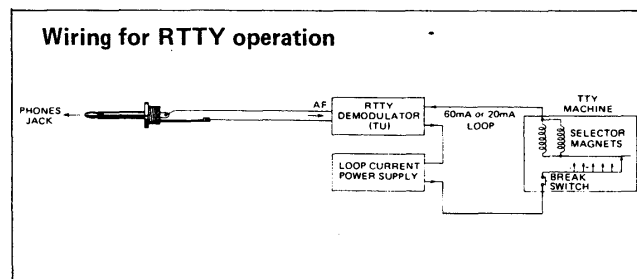

Audio signals for the demodulator can be supplied from the RECORDER jack or the PHONES jack on the front panel.

Set the operating mode for RTTY, by pushing the MODE SELECT switch "RTTY". The other controls are the same as those for SSB reception. When tuning a RTTY signal, set the TUNING RATE SELECT switch OFF (out) position, and tune to get audio signals of 2125Hz for MARK and 2295MHz for SPACE. (Use the tuning indicator of the terminal unit for easy tuning.) Also adjust the P.B. Tune control for clear reception.

When an optional CW narrow filter is installed, by pushing the N switch of the FILTER switches, the narrow filter is activated and the total selectivity of the RTTY reception is improved (250Hz or 500Hz at -6dB depending on which optional filter is installed) the same as the CW mode.

If you wish to receive RTTY signals which have wider shift such as 425Hz and 850Hz shifts, prepare a demodulator suitable for the shift and use normal FILTER switch position.

5 - 8 AM OPERATION

Set the operating mode for AM, by pushing the MODE SELECT switch "AM". The other controls are the same as those for SSB reception.

When tuning an AM signal, tune for maximum signal strength as indicated on the S-meter and the clearest audio.

The FILTER SWITCHES select three conditions. The selectivity and Pass-Band-Tuning function will be as follows:

| FILTER SWITCH | BAND WIDTH | PBT CONTROL |
|---------------|------------|-------------|
| NORMAL | 2.8KHz | EFFECTIVE |
| WIDE | 6.0KHz | INOPERATIVE |
| NARROW | 500Hz* | EFFECTIVE |

* When optional CW filter, FL-32 is installed.

When you wish to receive lower frequency than 1600KHz with a single wire antenna, connect the antenna to the LOW BAND ANTENNA terminal and set the antenna switch to the "1" position.

If you use an antenna tuner to convert the antenna impedance to 50 ohms, connect its feeder to the ANTENNA connector and set the antenna switch to the "2" position.

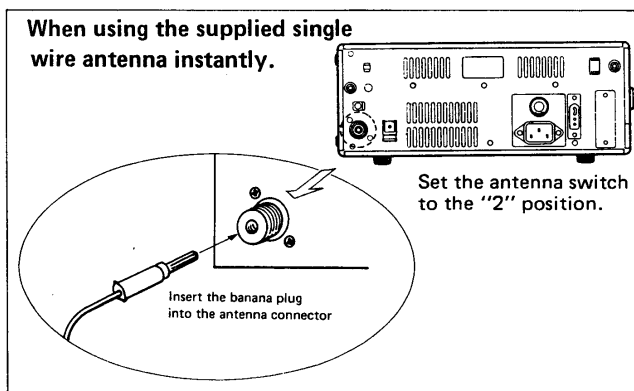

5 - 9 FM OPERATION (Option)

Set the operating mode for FM, by pushing the FUNCTION KEY first, then the MODE SELECT switch "AM". The other controls are the same as those for SSB reception, however, the Pass-Band-Tuning control, Notch Filter, Noise Blanker, AGC circuits and FILTER SWITCHES do not work in this mode.

When tuning an FM signal, tune for maximum signal strength as indicated on the meter and to be indicated the letters "TUNE" on the frequency display.

NOTE: Most countries do not allow use of the FM mode on HF bands except the 28MHz HAM band.

5 - 10 OTHER OPERATIONS

5 - 10 - 1 WWV RECEPTION

To receive WWV (or other standard frequency station), set the operating band to 10MHz, and the MODE to AM or SSB. Tune to 10.000.0MHz on the frequency display.

Since the IC-R71 has a General Coverage capability, any of WWV's frequencies can be received.

5 - 10 - 2 SIMPLE FREQUENCY ALIGNMENT

A very accurate frequency counter is necessary to align the frequency of the IC-R71. However, the frequency can be aligned simply by receiving the WWV signal.

1. Set the frequency display to 10.000.0MHz and be sure that you are receiving the WWV signal.
2. Set the operating mode to USB or LSB. Some beat tone can be heard.
3. Rotate the FREQUENCY SET Control, located under the access cover, so that the beat tone becomes zero beat.

5 - 10 - 3 SCOPE TERMINAL

This terminal brings out the 70MHz IF signal from the mixer in the receiver. Observation of not only the received signal, but also of signals of the selected band width are possible by using a panadapter or panoscope. (ICOM does not manufacture a panadapter.)

5 - 10 - 4 TRANSMITTER CONNECTION

This receiver can be used with a transmitter or transceiver for amateur radio service or other services.

Cable connections with a transmitter or transceiver are shown below.

Be sure to ground the mute terminal in the transmit mode.

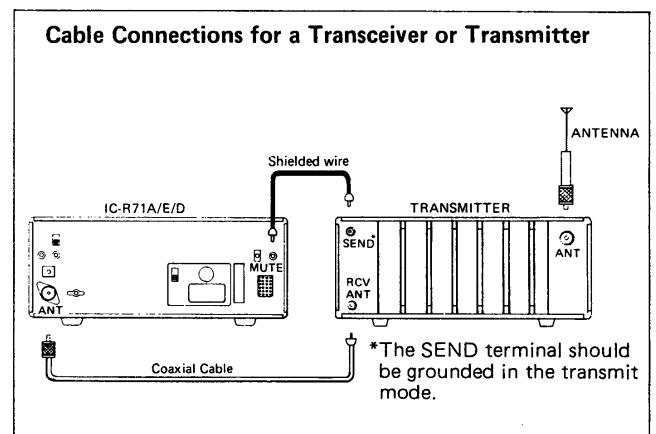

SECTION 6 CIRCUIT DESCRIPTION

The IC-R71 uses a phase-locked-loop (PLL) consisting of two loops for the local oscillator. The PLL is controlled by a Microcomputer system. The basic circuit uses an up-conversion with a First IF of 70.4515MHz and a Second IF of 9.0115MHz. Included within the MAIN Unit is the Pass Band Tuning circuit.

6 - 1 RF UNIT

Composed of a band-pass filter for each band, preamplifier, attenuator, 1st mixer and a 1st IF amplifier.

When a signal is received by the antenna, it passes through an appropriate band-pass filter which is chosen by a band signal from the LOGIC unit.

When the PRE/ATT switch is set at the PRE position, the signal is amplified by a wide-band amplifier about 10dB. This amplifier uses push-pull of junction FET's, 2SK125's to achieve low noise and wide dynamic range.

When the PRE/ATT switch is set at the ATT position, the signal bypasses the RF amplifier and goes to the attenuator circuit and is attenuated 20dB.

When the PRE/ATT switch is set at the OFF position, the signal bypasses both the RF amplifier and attenuator, and goes directly to the 1st mixer.

The 1st mixer is a double balanced mixer (DBM), where it is mixed with the 1st local oscillator signal from the PLL unit, becoming a 70MHz signal, passes through a pair of monolithic filter and is sent to the 2nd mixer in the MAIN unit through the 1st IF amplifier.

6 - 2 MAIN UNIT

Composed of the 2nd mixer, a crystal filter for each, SSB, AM and CW (option), IF amplifiers, Pass Band Tuning circuit, BFO, the SSB, AM detectors and IF amplifiers. In the 2nd mixer, (which is also a DBM), the signal is mixed with the 61.44MHz signal of the 2nd local oscillator signal from the PLL unit, and a 9MHz signal is obtained, and sent to the IF circuitry.

The circuit for the Noise Blanker consists of noise amplifiers, a noise detector, a pulse amplifier and AGC circuit which blocks the noise pulses at the IF when noise is present. The signal from the 2nd mixer is fed to the crystal filter, through an amplifier, to the IF amplifier, then to the Pass Band Tuning circuit composed of two mixers, 455KHz ceramic filters and the VXO circuit.

When the P.B.T. is turned ON the VXO frequency can be changed $\pm 1.8\text{KHz}$ ($\pm 3.3\text{KHz}$ in AM). The circuit makes a choice of what frequencies will pass electronically through the ceramic filter.

The P.B.T. will operate in all modes except FM.

Then the signal is sent to the second mixer then to the product detector, the squelch control and the AF attenuator. In the case of AM, the signal goes to the AM detector, then

to an AF amplifier, the squelch control and the attenuator. The AF signal from the attenuator is applied to a high performance and low distortion AF power amplifier IC, and amplified and fed to the speaker.

The BFO has two crystal units, one is for USB and the other is for LSB, CW and RTTY. The oscillation frequency is shifted to an appropriate value for each mode.

6 - 3 LOGIC UNIT

This unit is composed of proprietary CPU for treating data such as up/down signal detection control, the dial lock control circuit, the tuning rate select circuit, the band switching control circuit, code converter circuit, and the I/O control circuit.

The dial clock signals are generated by the rotary encoder directly connected to the tuning knob. The up/down control circuit detects the rotating direction of the tuning knob, and puts out the up/down control signal for the CPU.

The CPU is an 8-bit microcomputer which has a program to control the set. The CPU's functions are determined by the input signals, such as the dial clock signal, up/down signal and the signals from the function switches, and the CPU puts out signals to control the operating band, frequency, mode, tuning steps, display, and so on.

6 - 4 PLL UNIT

This unit is composed of two Phase-Locked-Loops for the first local oscillator and a crystal oscillator for reference frequency and the second local oscillator.

The crystal oscillator oscillates 30.72MHz. A part of this output is multiplied by 2 and a 61.44MHz signal is fed to the second mixer as the local oscillator signal. The other parts are divided for 10KHz and 5KHz as the reference frequencies of the main loop and sub loop.

The sub loop oscillates at 115 ~ 119.99MHz with 5KHz steps. This signal is divided by 500 to get 230 ~ 239.99 KHz with 10Hz steps, and mixed with 30.72MHz signal of the crystal oscillator (the mixer puts out 30.950 ~ 30.9599 MHz signal), then fed to the mixer of the main loop as the local oscillator signal.

The main loop puts out 70.55MHz ~ 100.45MHz, as the first local oscillator of the set, with 10Hz steps, for entire band. This loop has four VCO's which divide the oscillation frequency range into segments of; 70.55 ~ 78.45MHz, 78.45 ~ 85.45MHz, 85.45 ~ 92.45MHz and 92.45 ~ 100.45MHz to improve the C/N (Carrier/Noise) ratio.

SECTION 7 INSIDE VIEWS

7-1 TOP VIEW

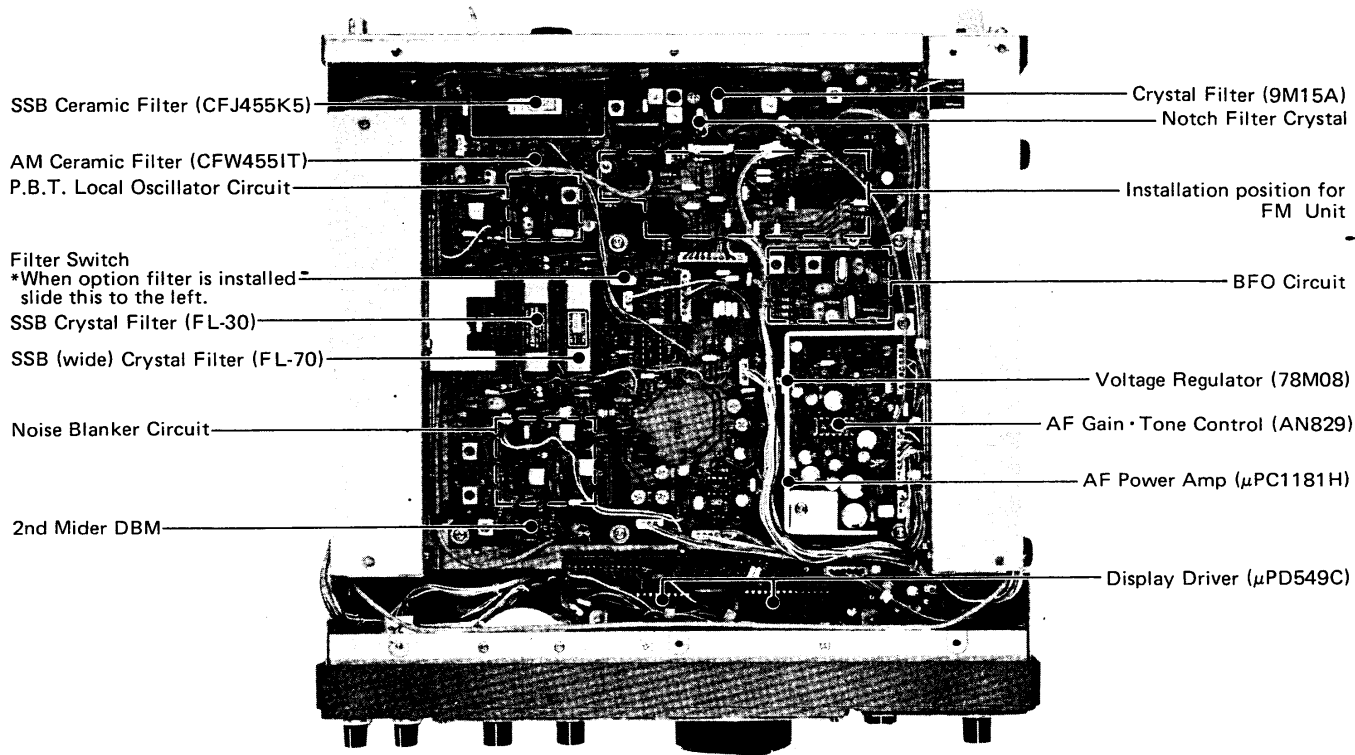

Don't tamper rotatable coil cores, trimmer capacitors, trimmer resistors, etc.

7-2 RF UNIT

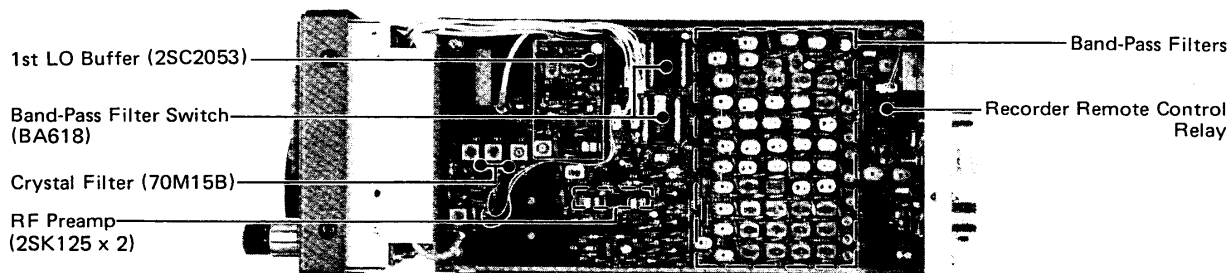

7-3 BOTTOM VIEW

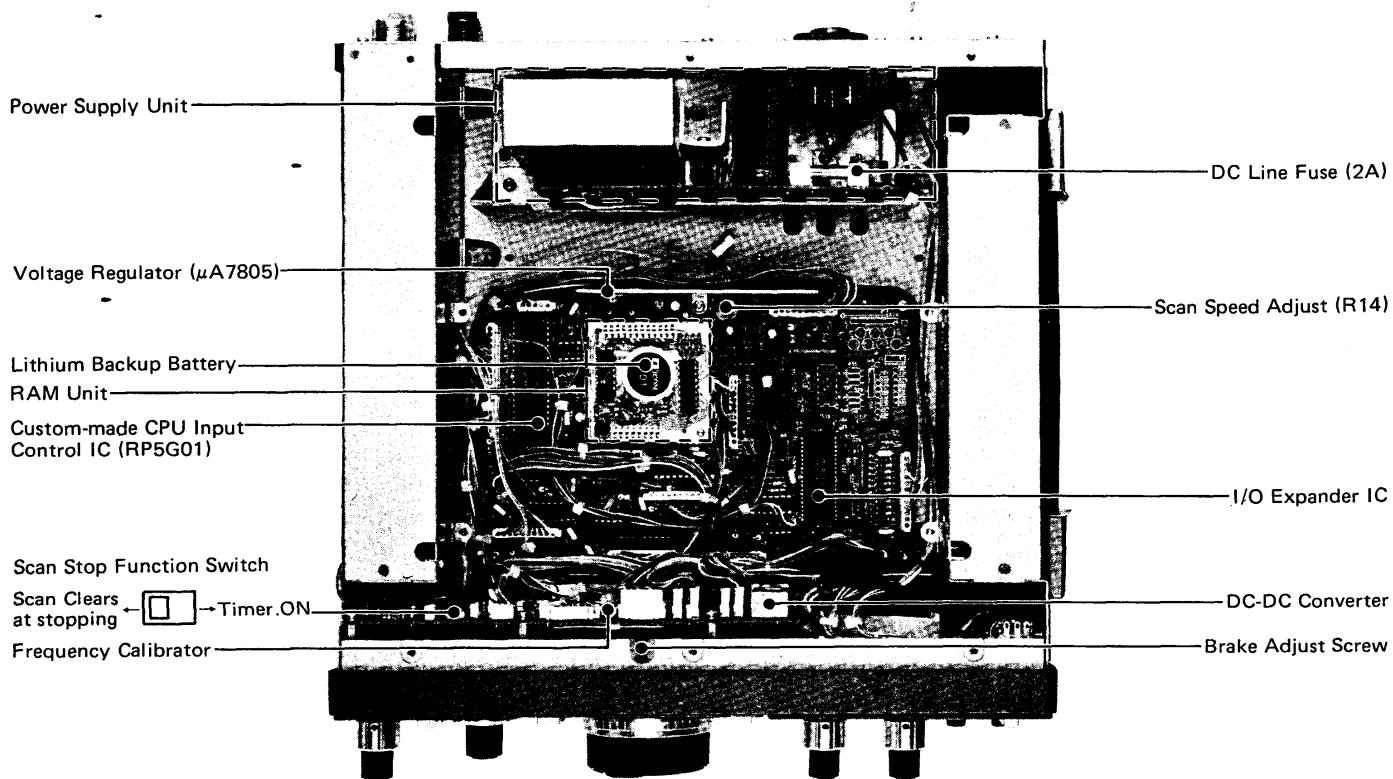

7-4 PLL UNIT

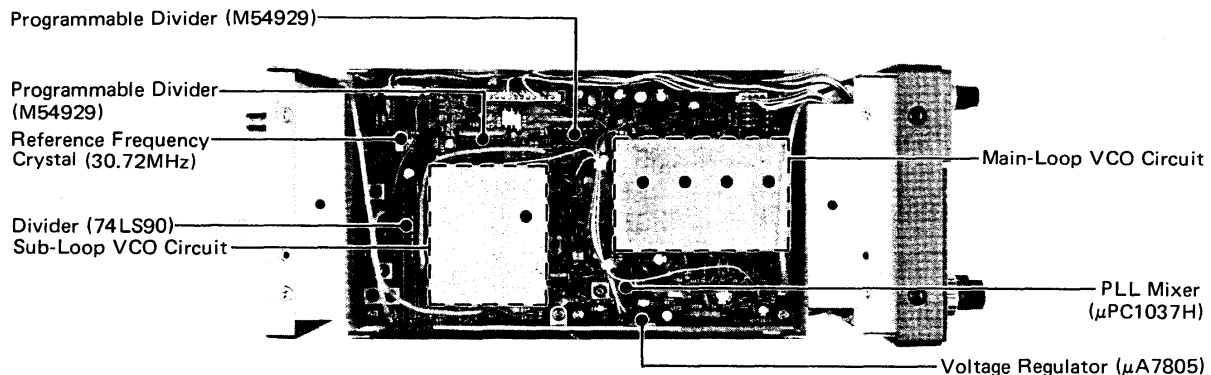

SECTION 8 OPTION INSTALLATION

8-1 INSTALLATION OF THE FM UNIT

Before performing any work on this receiver, make sure that the power cord is detached from the set.

1. Remove the top cover.
2. Install the FM unit to the position shown in the photo with the two screws supplied.
3. Plug the 2-pin plug from the front panel to J1 of this unit, P2 (6 pins) of this unit to J7 on the MAIN unit and P1 (2 pins coaxial cable) of this unit to J8 on the MAIN unit.
4. This completes the installation.
5. Replace the top cover.
6. No adjustment is required.

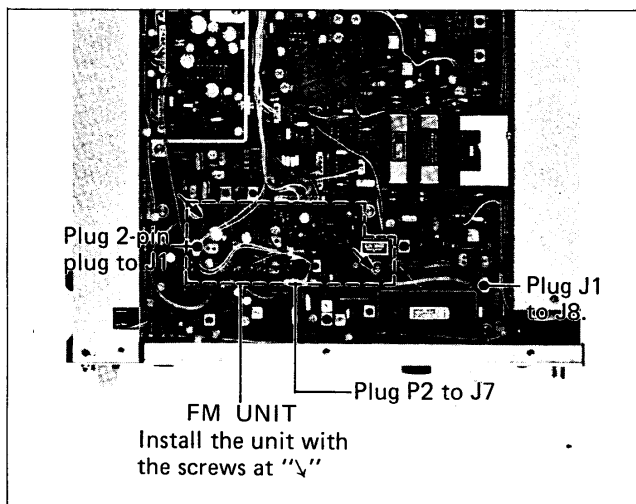

8-2 INSTALLATION OF THE FL-32 OR FL-63 NARROW CW FILTER

Before performing any work on this receiver, make sure that the power cord is detached from the set.

1. Remove the top cover.
2. Remove the filter clamping plate.
3. Plug in the FL-32 or FL-63 narrow CW filter to the position where indicated on the MAIN unit board. At this time, be sure to orient the filter so that the label of the filter is facing the same direction as the others.
4. Replace the filter clamping plate.
5. Replace the top cover.
6. No adjustment is required, and the filter provides 500Hz or 250Hz at -6dB pass-band.

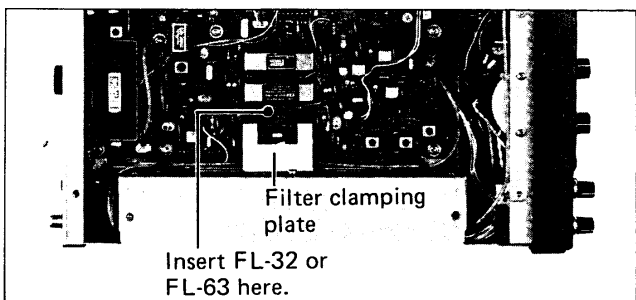

8-3 INSTALLATION OF THE FL-44A 455KHz SSB FILTER

The following tools are needed for the installation of the filter:

| | |
|---------------------|----------------------|
| Philips Screwdriver | Diagonal cutters |
| Screwdriver | Soldering Iron (40W) |
| Solder | Soldering tool |
| De-soldering braid | |

Before performing any work on the set, make sure that the power cord is detached from the receiver.

1. Remove the top cover.
2. Unscrew the seven screws retaining the MAIN unit board shown in the photo. Then turn the board over towards the front so that the foil side of the board can be seen.

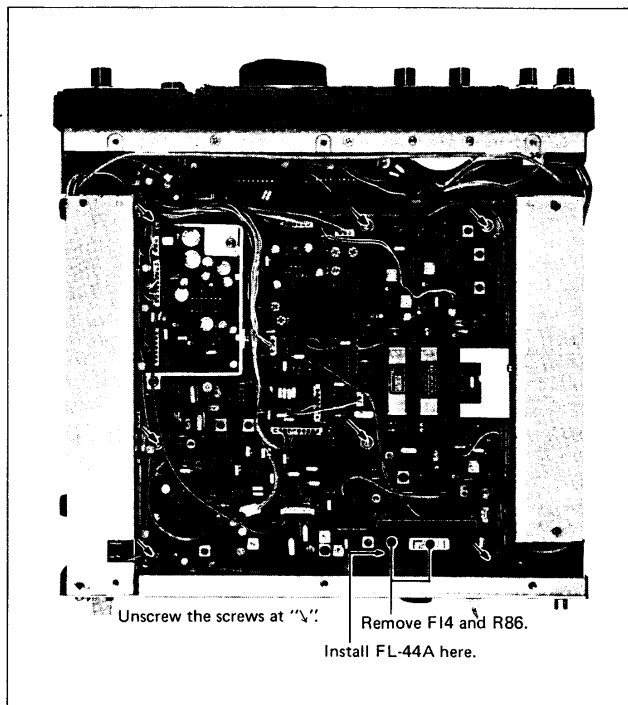

3. Remove the solder from the F14, ceramic filter and R86, resistor on the MAIN unit board shown in the photo, using a de-soldering braid, then remove the F14, ceramic filter and R86, resistor.
4. Insert the FL-44A to the position where the ceramic filter was installed and retain it with the two supplied nuts, Solder its terminal pins.
5. Replace the MAIN unit board and top cover.
6. No adjustment is required for operation.

8 - 4 VOICE SYNTHESIZER UNIT IC-EX310

When this unit is installed, the set announces the displayed frequency by pushing the SPEECH switch on the front panel.

8 - 4 - 1 ASSEMBLY PROCEDURE

1. Turn the receiver upside down.
2. Remove the option unit installation plate by unscrewing the retaining screws as shown in the photo.

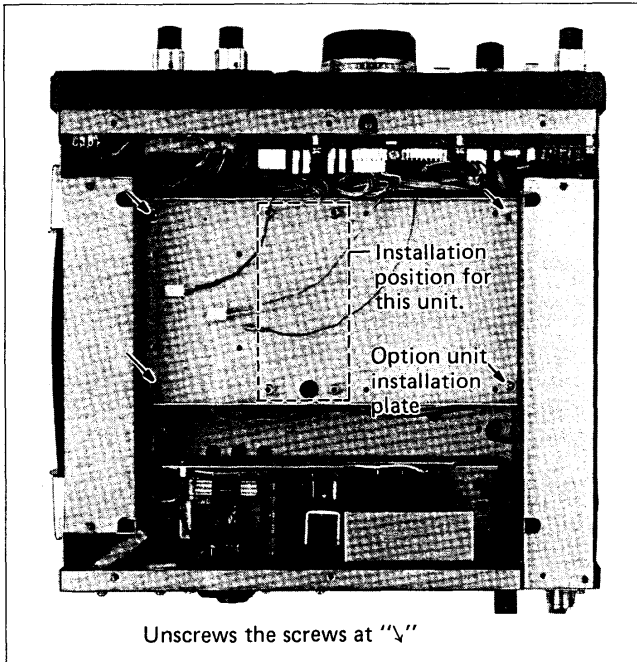

3. Insert 8-pin plug of this unit into J12 of the LOGIC unit as shown in the photo.

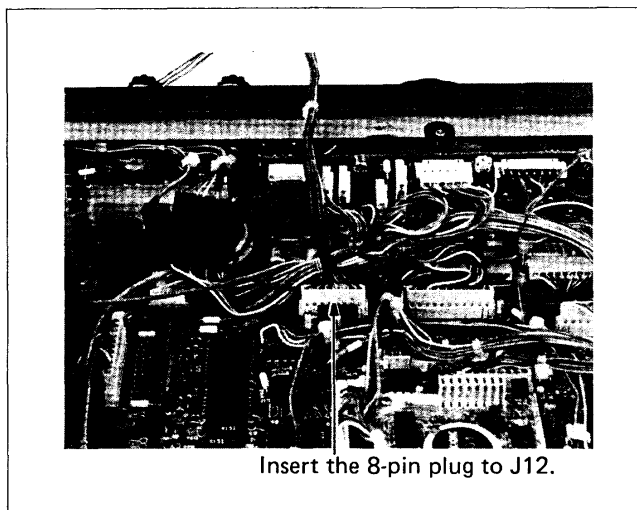

4. Put the unit beside the front panel, then replace the option unit installation plate as before. At this time, put the wires with the 2-pin plugs and 1-pin plug on the plate.
5. Attach this unit on the plate as shown in the photo. Then plug the gray shielded wire with 2-pin plug to J2 of this unit.

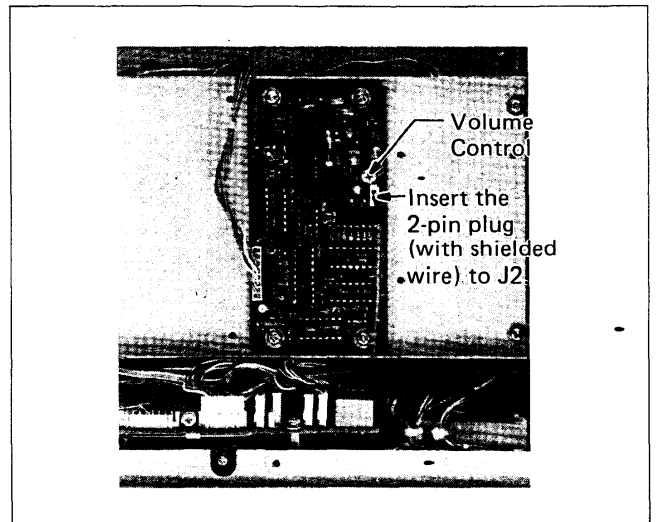

6. Adjust its volume and speaking speed if necessary. (Described below.)

7. Replace the top and bottom covers of the set.

8 - 4 - 2 ADJUSTMENT

1. Adjust the volume of the speech and speaking speed before the top and bottom covers are replaced, if necessary.
2. Connect a power source and turn on the power switch.
3. By pushing the SPEECH switch, the unit is actuated and announces the displayed frequency in English.
4. The volume of the announce is adjustable with R30 on the synthesizer unit. Adjust it for comfortable level.
5. By cutting W1 jumper wire, speaking speed becomes faster.
6. Replace the top and bottom covers of the set.

8 - 4 - 3 HOW THE VOICE SYNTHESIZER UNIT WORKS

1. When "14.231.5MHz" is displayed, and pushing the SPEECH switch;

"ONE FOUR POINT TWO THREE ONE FIVE MHz", will be heard.

2. When a blank memory channel is selected;

"POINT MHz", will be heard.

8 - 5 HIGH-STABILITY CRYSTAL UNIT CR-64

8 - 5 - 1 FEATURES

This high-stability crystal unit is consisted of a temperature-

compensating oven heater and a crystal unit. By replacing the original crystal unit with this unit, the total frequency stability of the set will be improved.

The specifications of the crystal unit itself are as follows:

Oscillation frequency: 30.72MHz \pm 10ppm

Stability: \pm 0.5ppm in the range of $-30^{\circ}\text{C} \sim +60^{\circ}\text{C}$

8 - 5 - 2 ASSEMBLY PROCEDURE

1. Turn the receiver left-side up.
2. Unscrew the six screws retaining the PLL board, then turn the board over so that foil side can be seen.
3. Remove the solder of the original crystal unit terminal pins and grounding lead on the foil of the PLL board, by a de-soldering braid, then take off the crystal unit and grounding lead.
4. The location for the high-stability crystal unit is shown in the photo. The holes for the terminal leads of the unit are predrilled. If the holes are filled with solder, remove the solder with a de-soldering braid.

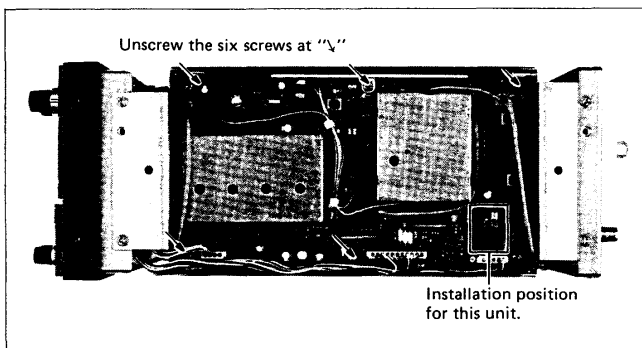

Be sure to orient the unit so that the crystal and heater terminal leads (indicated on the bottom of the unit) are the same direction as shown on the photo.

Insert the unit flush with the board, bend the leads flush with foil side of the board and solder them in.

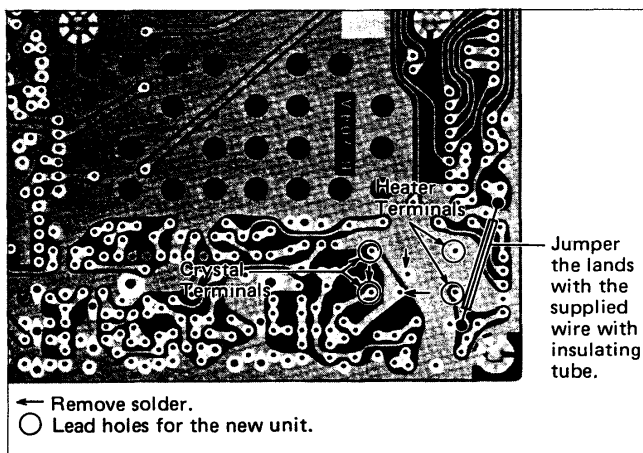

5. Trim the leads even with the solder points.

6. Jumper the lands of the foil indicated in the photo by using the supplied wire with insulating tube. At this time, take care not to make short with other lands of the foil.

7. This completes the installation. Replace the PLL board, and the top and bottom covers.

8 - 5 - 3 OPERATION

No adjustment is required and the unit improves the frequency stability of the set as follows:

Frequency Stability of IC-R71 with CR-64:

Less than \pm 50Hz after switch on 1 min to 60 mins, and less than \pm 10Hz after 1 hour at normal room temperature. Less than \pm 100Hz in the range of $-10^{\circ}\text{C} \sim +60^{\circ}\text{C}$.

8 - 6 INTERFACE UNIT IC-EX309

When the IC-EX309 is installed, the operating frequency, mode, memory write, memory read etc. of the set can be controlled by a personal computer through the ICOM CT-10 optional interface unit.

8 - 6 - 1 ASSEMBLY PROCEDURE

1. Turn the receiver upside down, and remove the option unit installation plate by unscrewing the retaining screws.
2. Remove the "PLATE B" attached to the rear panel by unscrewing two screws. These screws will be used later.
3. Pass the accessory socket cable (the end attached 9-pin and 8-pin connectors) through the hole which was attached the PLATE B before, from the outside of the chassis. Then attach the accessory socket by using the screws described above.
4. Insert the 9-pin connector to J10 and the 8-pin connector to J15 of the LOGIC unit respectively.

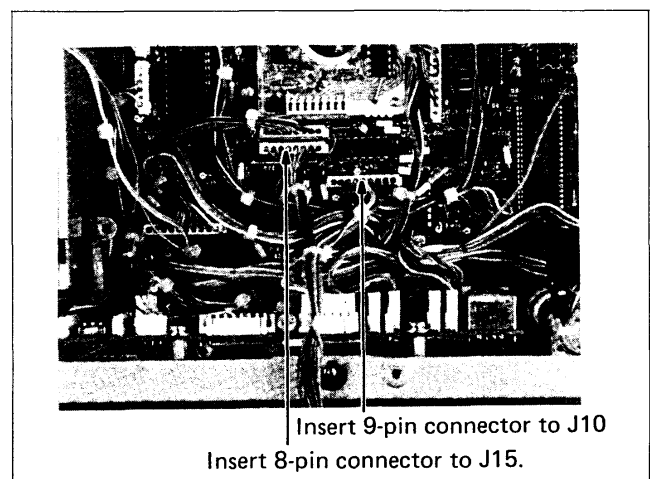

- Put the unit aside the front panel, then replace the option unit installation plate.
- Attach the unit to the plate as shown in the photo. Insert the 8-pin and 9-pin connectors from the accessory socket to the connectors on this unit respectively. Then the 2-pin connector (with red wire and yellow wire) to the 2-pin connector on this unit.

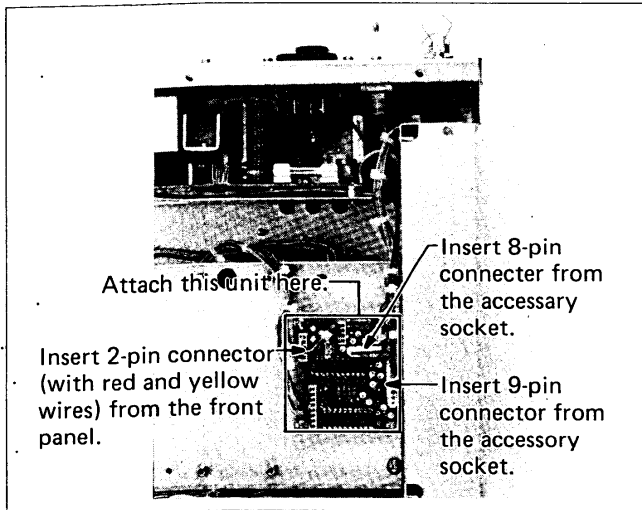

- Replace the top and bottom covers of the set.

8 - 7 REMOTE CONTROLLER UNIT

This unit is included with the infrared-ray remote controller RC-11.

8 - 7 - 1 ASSEMBLY PROCEDURE

- Turn the receiver upside down, and remove the option unit installation plate by unscrewing the retaining screws. (See page 22 for location.)
- Remove the 6-pin jumper plug as shown in the photo.

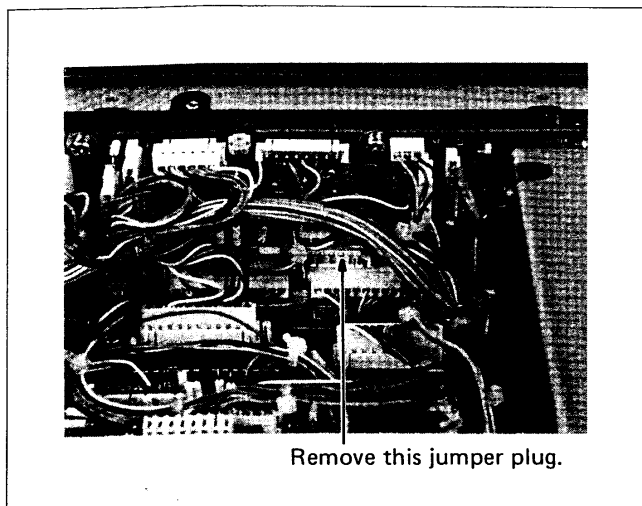

- Insert the 6-pin connector of the controller unit to the connector which had the jumper plug before. Then insert the 7-pin connector to J3 on the front panel board and the 8-pin connector to J12 on the front panel board respectively. In addition, connect the purple wire from the LOGIC unit to J3 of this unit.

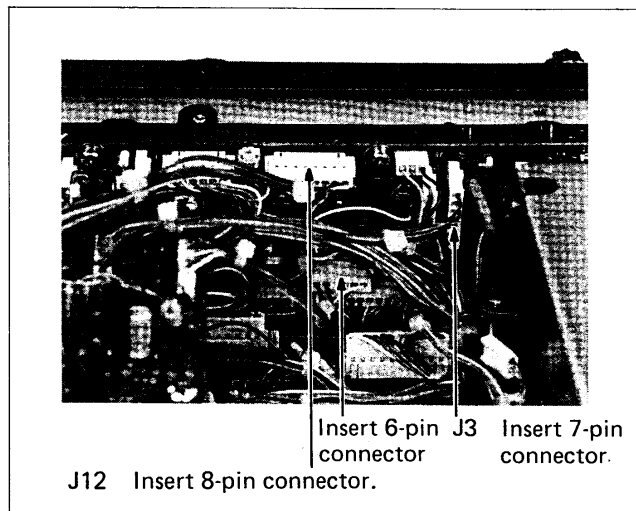

- Put the unit aside the front panel, then replace the option unit installation plate.
- Attach the unit as shown in the photo.

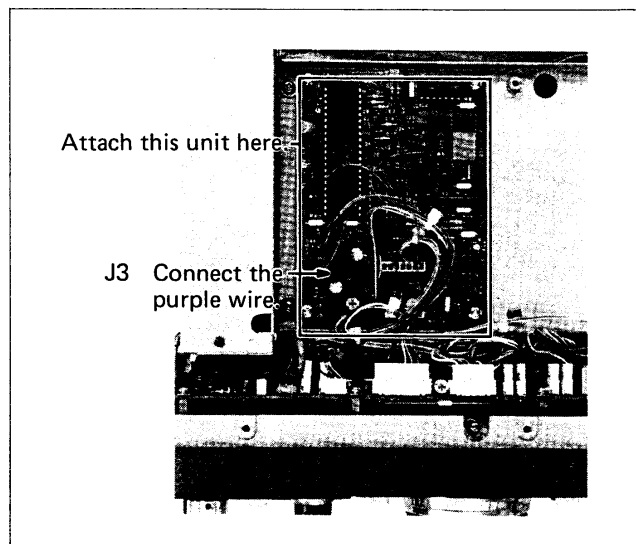

- Replace the top and bottom covers of the set.

SECTION 9 TROUBLESHOOTING

Your IC-R71 has been carefully adjusted at the factory prior to shipping. The chart below has been provided to help you correct problems which are not equipment malfunctions. If you are unable to locate the trouble, or correct the fault, please contact your dealer or the nearest ICOM Service Center.

| Problem | Possible Cause | Solution |
|---|---|--|
| 1. Power does not come on when the switch is pushed. | Power cable is improperly connected. Blown fuse. | Carefully reconnect power cable. Check for the cause, then replace the fuse with a spare one. |
| 2. No sound comes from the speaker. | AF GAIN control knob is completely counterclockwise. The external speaker cable is connected to the unit but not to the external speaker jack on the external speaker. Headphones are connected to the PHONES jack. | Turn the knob clockwise to a suitable level. Connect the cable to the speaker jack on the external speaker. Unplug the headphones. |
| 3. Sensitivity is low and only strong signals are audible. | RF GAIN control knob is turned fully counterclockwise. The antenna feed line is cut or shorted. The Attenuator is ON. | Turn the RF Gain control knob fully clockwise. Check the feed line and correct any improper condition. Set the PRE/ATT switch to OFF position or PRE position. |
| 4. The "S" meter is higher than the "0" position even when there is no signal. | RF GAIN control knob is turned fully counterclockwise. | Turn the knob fully clockwise. |
| 5. Only incomprehensible voices are heard during SSB reception. | Receiving the wrong sideband. | Set the sideband opposite the one you are receiving, either USB or LSB. |
| 6. The tone of the received signal is very high or low pitched. | Maladjustment of the P.B. Tune control. | Set the P.B. Tune control knob to the clear tone position, or the center position. |
| 7. The frequency does not change by rotating the Tuning knob. | DIAL LOCK is engaged. | Disengage the DIAL LOCK by pressing the DIAL LOCK button. |
| 8. An abnormal figure is displayed on the frequency display or fails to illuminate. | The Power switch was turned OFF and ON too quickly. | Turn the Power switch OFF, wait 30 seconds, and then turn it ON again. |
| 9. An abnormal out of band frequency is displayed on the frequency display. | The memory backup battery (graphite-lithium battery) on the RAM board is exhausted. | Contact with your dealer or ICOM service center. |

SECTION 10 BLOCK DIAGRAM

RF/MAIN UNITS

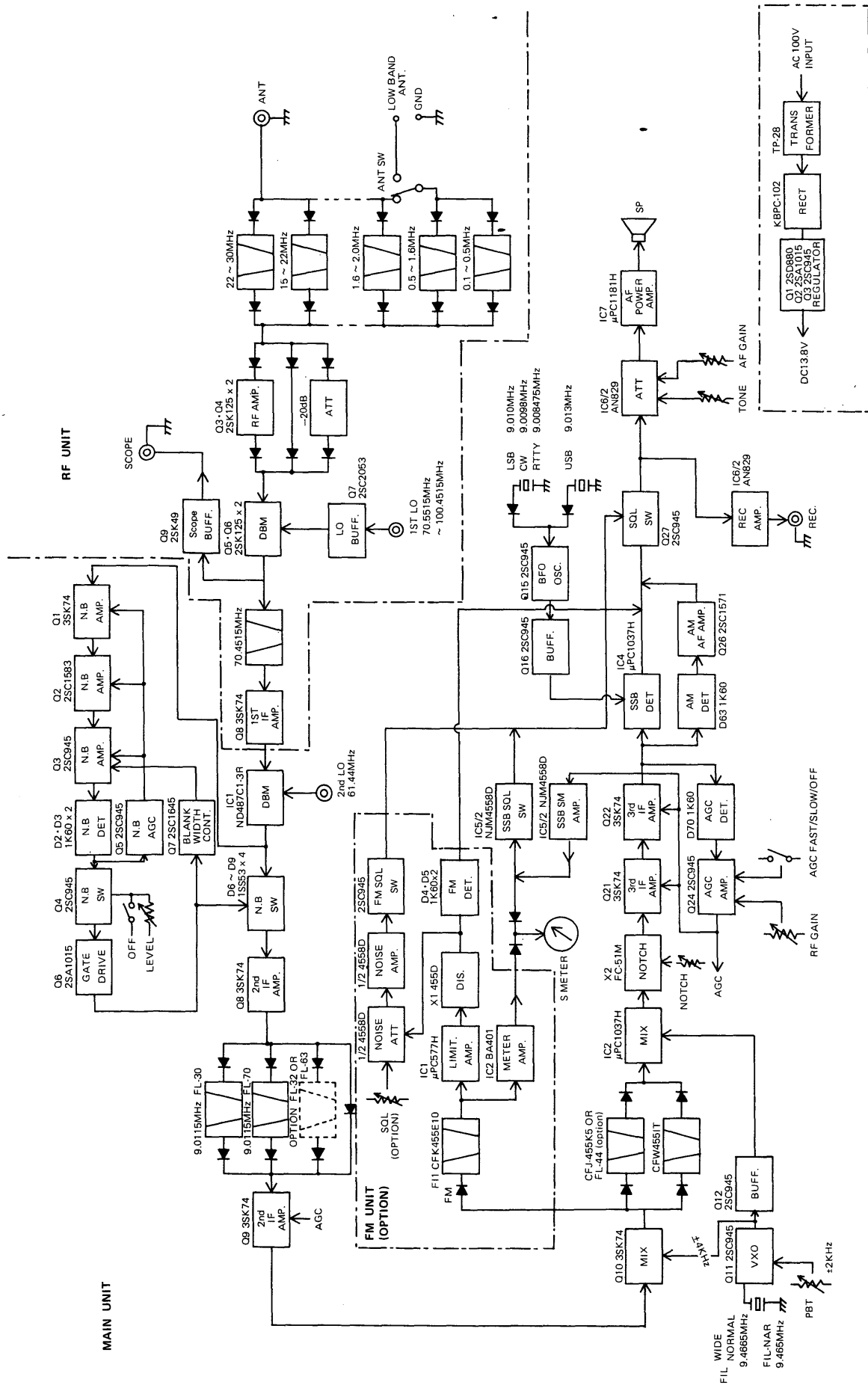

PLL/LOGIC UNITS

PLL UNIT

EXIT Remote Interface (option)

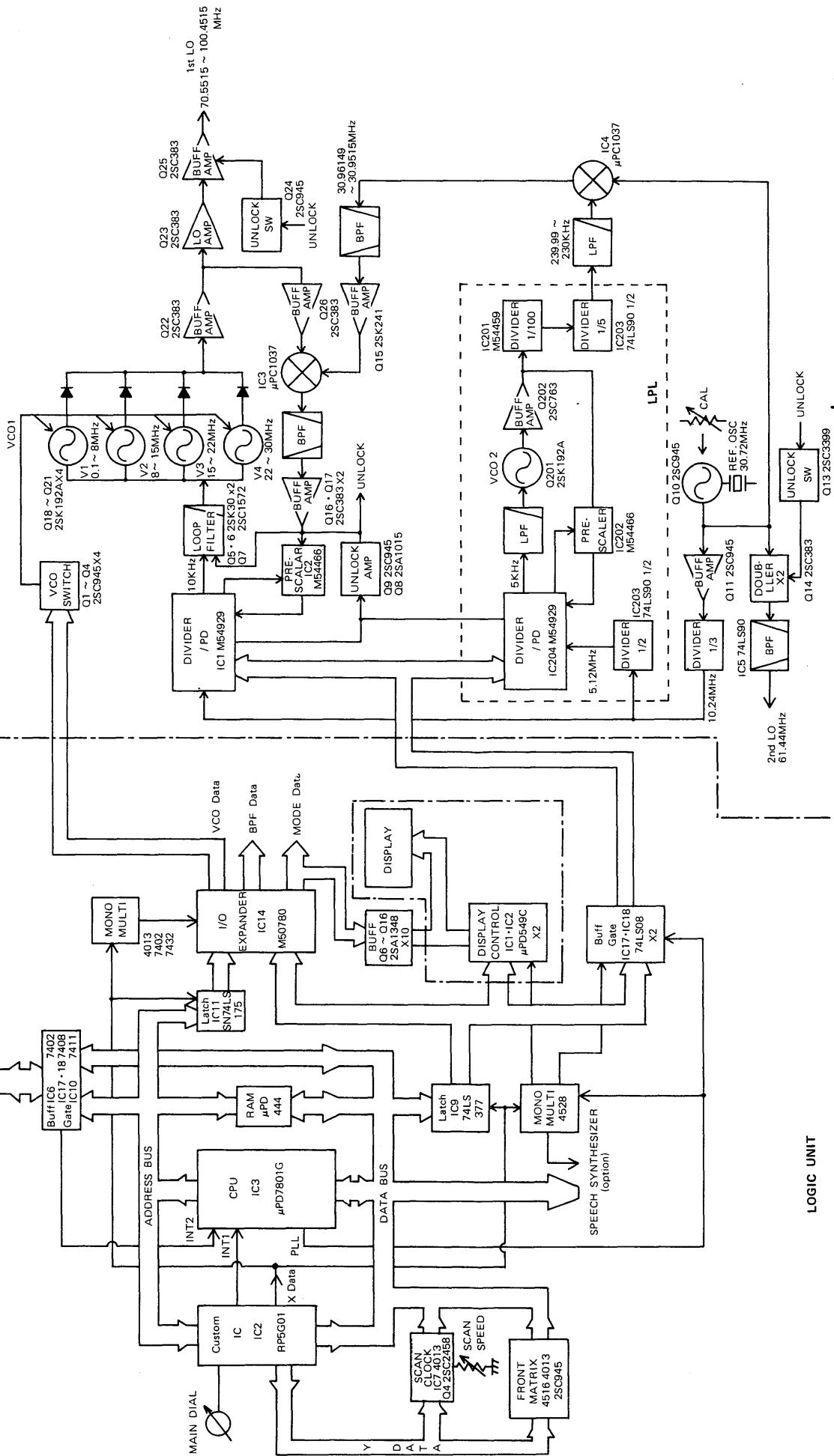

FREQUENCY ALLOCATION CHART

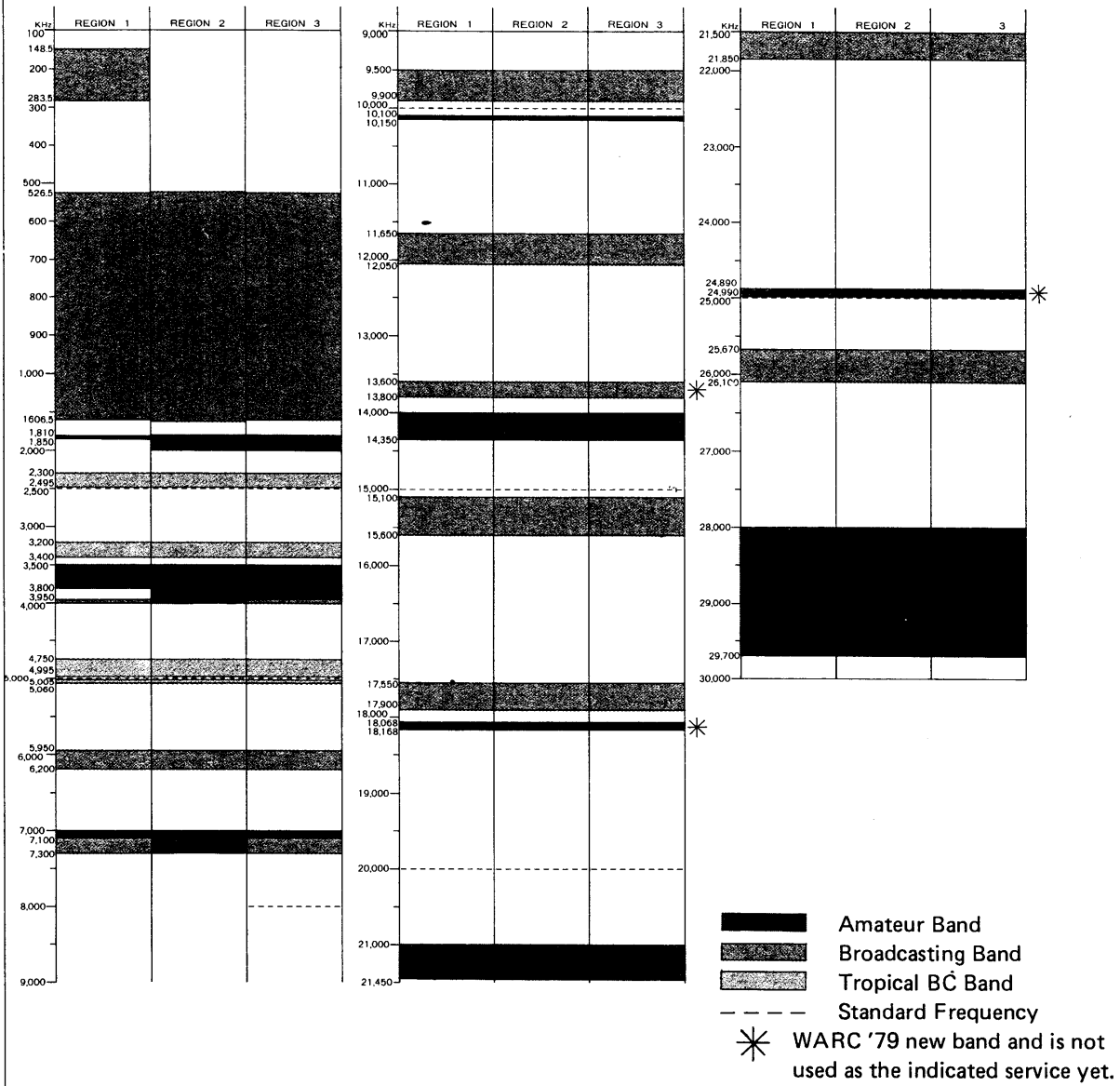



ICOM INCORPORATED
1-6-19, KAMIKURATSUKURI HIRANO-KU,
OSAKA JAPAN

A-0533
Printed in Japan