

ADJUSTMENT

Measuring Equipment for Adjustment

1. Tester
Input impedance: High
2. RF valve voltmeter (RF V.M)
Input impedance: $1\text{M}\Omega$ or more, 2pF or less
Voltage range: Full scale = 10mV to 300V
Measurable frequency range: Up to 450MHz
3. Frequency counter (f. counter)
Input sensitivity: About 50mV
Measurable frequency: 450MHz or more
4. DC power supply
Voltage: Variable in the range 10 to 17V
Current: 13A or more
5. Power meter
Measurement power: 60W , 3W , 1W
Impedance: 50Ω
Measurable frequency: 450MHz
6. AF valve voltmeter (AF V.M)
Input range: Full scale = 1mV to 30V
Measurable frequency range: 50Hz to 10kHz
7. AF generator (AG)
Output frequency: 100Hz to 10kHz
Output voltage: 0.5mV to 1V
8. Line detector
Measurable frequency: 450MHz
9. Spectrum analyzer
Measurable frequency: 450MHz
10. Directional coupler
11. Oscilloscope
High sensitivity with horizontal input terminal
12. Standard signal generator (SSG)
The standard signal generator must be able to generate the 144 and 430MHz band frequencies and vary the amplitude and frequency.
Output: -20 to $100\text{dB}\mu$.
13. Dummy load
 8Ω about 5W
14. Noise generator
The noise generator must be able to generate noise similar to ignition noise containing high-frequency components of 450MHz or more.
15. Sweep generator
The sweep generator must be able to sweep the 144 and 430MHz bands.
16. Tracking generator

Preparation

- Set the controls and switches to the positions listed below unless otherwise specified.
VOL control Fully counterclockwise
SQL control Fully counterclockwise
POWER switch OFF
DC power supply POWER switch
(For fixed stations) OFF

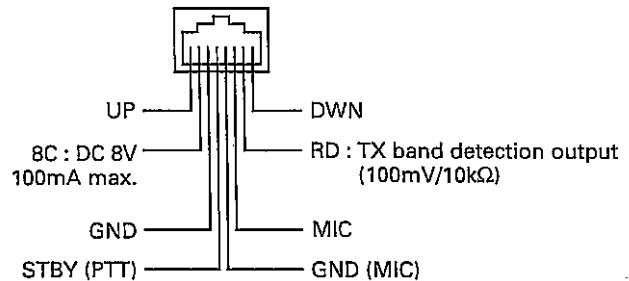

**Microphone socket
(as viewed from the front of the set)**

- Use an insulated rod, such as a plastic rod, for adjustment (especially for trimmers, coils, etc.).
- To protect the signal generator, never connect the microphone socket when the receiver section is adjusted.
- Before the power cord is connected, make sure the power switch is off.
- See the instruction manual for transmit and receive operations.

ADJUSTMENT

Common Section

Item	Condition	Measurement			Adjustment			Specifications/Remarks
		Test-equipment	Unit	Terminal	Unit	Parts	Method	
1. Setting	1) Source voltage : DC 13.8V POWER : OFF VOL., SQL knob : Minimum							
2. Reset	1) MR key + POWER ON After the check, MR key : Press						Check	All indicator of LCD on.
3. PLL	1) Frequency : 146.000MHz Transmit/Receive	DC V.M Dummy load	TX-RX Rear panel	TP2 ANT			Check	RX : 1.2 to 9.0V TX : 1.2 to 9.0V
4. Transmission frequency	1) Frequency : 146.000MHz Transmit	f. counter Power meter	Rear panel	ANT	TX-RX	TC1	146.000MHz	±100Hz

Receiver Section

Item	Condition	Measurement			Adjustment			Specifications/Remarks
		Test-equipment	Unit	Terminal	Unit	Parts	Method	
1. BPF	1) Frequency : 146.05MHz K,M2,M3 145.04MHz M SSG output : -93dBm MOD : 1.0kHz DEV : ±3.0kHz	Tester SSG Oscilloscope	TX-RX Rear panel	TP1 ANT EXT. SP	TX-RX	L1~L6	For max. voltage of TP1, align from L1 to L6.	
	2) SSG output : -113dBm						For max. voltage of TP1, repeat the alignment from L1 to L6, twist.	
2. Sensitivity	1) Frequency K,M2,M3 : 146.05, 144.05, 147.95MHz M : 145.04, 144.04, 145.94MHz SSG output : -121dBm K -122dBm M,M2,M3 AF : 0.63V/8Ω	SSG Distortion meter AF V.M Oscilloscope	Rear panel	ANT EXT. SP			Check	More than SINAD 12dB
3. Distortion	1) Frequency : 146.05MHz K,M2,M3 145.04MHz M SSG output : -53dBm AF : 4.0V/8Ω						Check	Less than 3.0%
4. Hum and Noise ratio	1) Frequency : 146.05MHz K,M2,M3 145.04MHz M SSG output : -53dBm MOD : OFF AF : 2.83V/8Ω	SSG AF V.M Oscilloscope	Rear panel	ANT EXT. SP			Check	More than S/N 46dB
5. S-meter	1) Frequency : 146.05MHz K,M2,M3 145.04MHz M SSG output : -95dBm	SSG LCD	Rear panel	ANT	TX-RX	VR1	Align so that all the S-meter go on, then the last segment goes off.	
	2) SSG output : -93dBm						Check	All S-meter segments on.
	3) SSG output : OFF							S-meter segments off.

ADJUSTMENT

Item	Condition	Measurement			Adjustment			Specifications/Remarks
		Test-equipment	Unit	Terminal	Unit	Parts	Method	
6. Squelch	1) Frequency : 146.05MHz K,M2,M3 145.04MHz M SSG output : OFF Align so that noise is not audible by SQL knob.	SSG Ammeter	Rear panel	ANT			Check	Maker position of SQL knob 8 : 00~11 : 00 BUSY indication off. Less than 0.6A
	2) SSG output : -127dBm	Oscilloscope		EXT. SP			Check	Squelch opens. BUSY indication on.
	3) SSG output : -113dBm SQL knob : Maximum After the check, SQL knob : Minimum						Check	Squelch opens.

Transmitter Section

Item	Condition	Measurement			Adjustment			Specifications/Remarks
		Test-equipment	Unit	Terminal	Unit	Parts	Method	
1. Power	1) Frequency : 146.000MHz K,M2,M3 144.98MHz M TX-RX unit VR4 : Maximum Transmit	Power meter Ammeter	Rear panel	ANT			Check	More than 55.0W K,M2,M3 More than 13.0W M ON AIR indication on. All RF-meter segments on.
	2) Frequency : 146.000MHz K,M2,M3 144.98MHz M Transmit				TX-RX	VR4	52.0W K,M2,M3 12.0W M	$\pm 1.0W$, Less than 11.0A K,M2,M3 $\pm 1.0W$, Less than 3.5A M
	3) Frequency : K,M2,M3 : 144.00, 147.975MHz M : 144.00, 145.98MHz Transmit						Check	44.0~60.0W, Less than 11.0A K,M2,M3 10.0~14.0W, Less than 3.5A M
	4) F key → LOW key (M on.) Frequency : 146.000MHz K,M2,M3 144.98MHz M Transmit				TX-RX	VR5	12.0W K,M2,M3 1.0W M	$\pm 1.0W$ K,M2,M3 $\pm 0.15W$ M
	5) F key → LOW key (L on.) Frequency : 146.000MHz K,M2,M3 144.98MHz M Transmit						Check	3.0~8.0W K,M2,M3 0.3~0.8W M
2. DEV	1) Frequency : 146.000MHz K,M2,M3 144.98MHz M AG : 1kHz/50mV K,M2,M3 1kHz/25mV M Transmit	Modulation analyzer Oscilloscope	Rear panel	ANT	TX-RX	VR3	$\pm 4.4kHz$ (Align absolute value of + or - value.)	$\pm 0.2kHz$ No abnormal oscilloscope wave.
	2) AG : 1kHz/5mV K,M2,M3 1kHz/2.5mV M Transmit	AG AF V.M	Front panel	MIC			Check	$\pm 2.2\sim 3.6kHz$ Nor abnormal oscilloscope wave.
3. Tone	1) Frequency : 146.000MHz K,M2,M3 144.98MHz M TONE key : Press (T on.) Transmit After the check, TONE key : Press (T off.)	Modulation analyzer Oscilloscope	Rear panel	ANT			Check	$\pm 0.5\sim 1.5kHz$

ADJUSTMENT

Item	Condition	Measurement			Adjustment			Specifications/Remarks
		Test-equipment	Unit	Terminal	Unit	Parts	Method	
4. Single tone	1) POWER : OFF MHz key + REV key + POWER ON Frequency : 146.000MHz K,M2,M3 144.98MHz M Transmit	Modulation analyzer Oscilloscope	Rear panel	ANT			Check	±0.8~1.5kHz
5. DTMF	1) Frequency : 146.000MHz K,M2,M3 144.98MHz M Press the DTMF key of transmission jig.							Check
6. Protection	1) Frequency : 146.000MHz K,M2,M3 144.98MHz M POWER : HI (F key + LOW key) ANT : Open and short Transmit	Ammeter					Check	Less than 11.0A K,M2,M3 Less than 4.0A M
7. CTCSS	1) Only TSU-8 is installed set. Frequency : 145.100MHz (CTCSS : 88.5Hz) TX-RX-communicate between testing set and monitor set.	Monitor	Rear panel	ANT			Check	Their sets are able to TX-RX-communicate.
	2) Frequency : 145.100MHz (CTCSS : 103.5Hz)	50Ω dummy load						Their sets are not able to TX-RX-communicate.

Adjustment Points

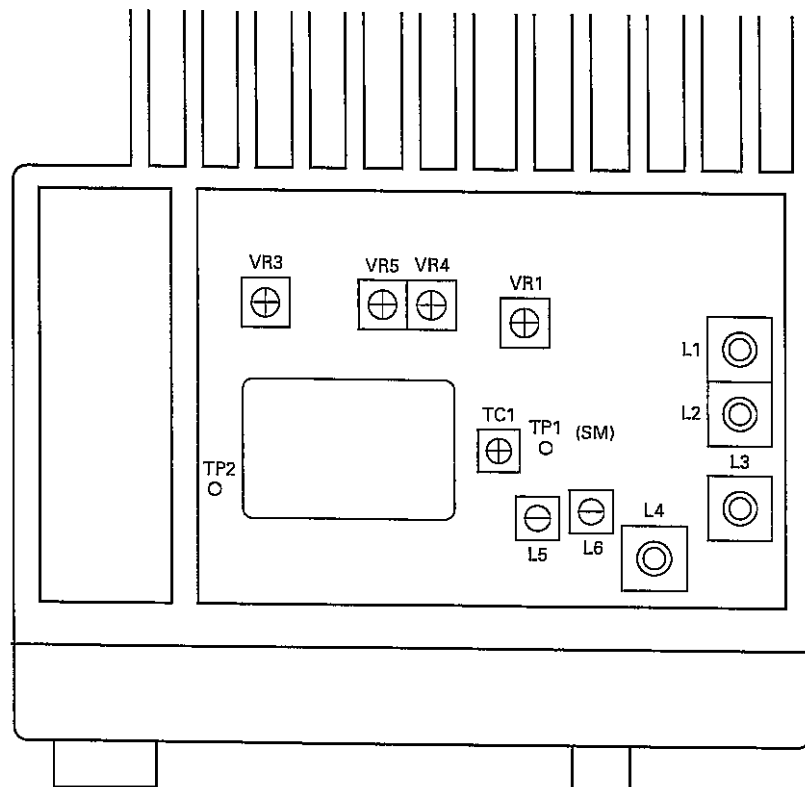

Jig (13 Pin Flat cable)

This is the same cable as TM-241's cable.

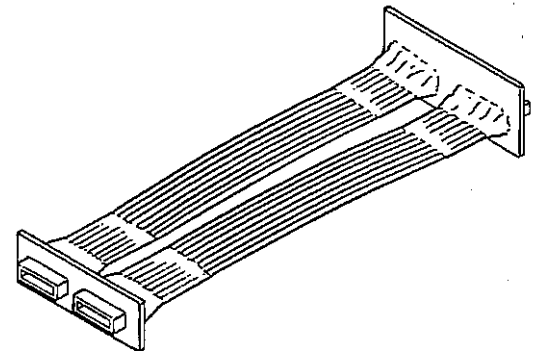

TC1 : Transmission frequency
L1~6 : BPF
VR1 : S-meter
VR3 : DEV
VR4 : HI power
VR5 : MID power

SCHEMATIC DAIGRAM TM-261A

DTA114YK 2SA1037K
 DTC114EK 2SA1519
 DTC123JK 2SC2059K
 DTC124EK 2SC2412K
 DTC143EK 2SC2713
 DTC144EK 2SC3120
 DTC144WK 2SC4116
 DTC363EK 2SC3324



2SB1132
 2SB1302

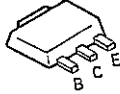

2SD1406

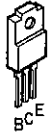

TA78L06F

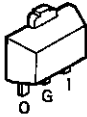

NJM78L05UA

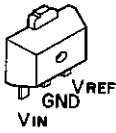

2SJ106
 2SK208
 2SK508NV



TA7808S



3SK131
 3SK184

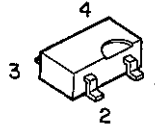

M57737
 S-AV17

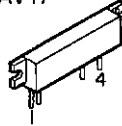

FMW1

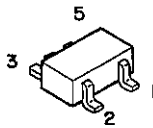

BU4S66

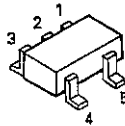

PST9130NR

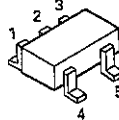

LA5010M
 NJM4558E

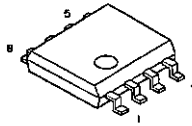

LC73881M

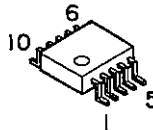

LA4446

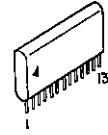

TA7787AF

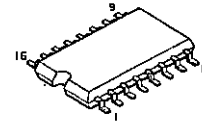

BU2090FS

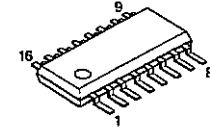

M54959FP

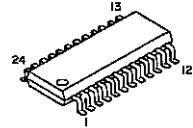

M38267M8L103FP
 M38267M8L104FP
 M38267M8L105FP

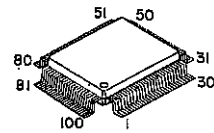

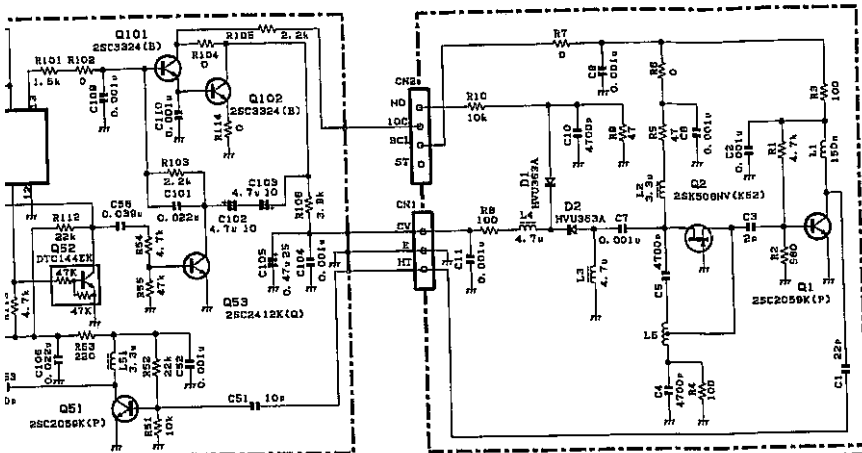

- IC201: M39267M81104P
- IC205, 212, 213: BU4566
- IC207: NJM4558E
- IC208: TA76105F
- IC209: P5T9130NR
- IC210: X25160S1-2.7
- IC211: LC73881M

- Q201: 2SA1518
- Q202, 204: DTC114EK
- Q203: 2SC4116 (GR)
- Q205: 2SC4116 (Y)

- D201, 205, 206, 208, 209: MA110
- D202: DTZ7.5 (B)
- D203, 204: MAT29
- D207: MA112

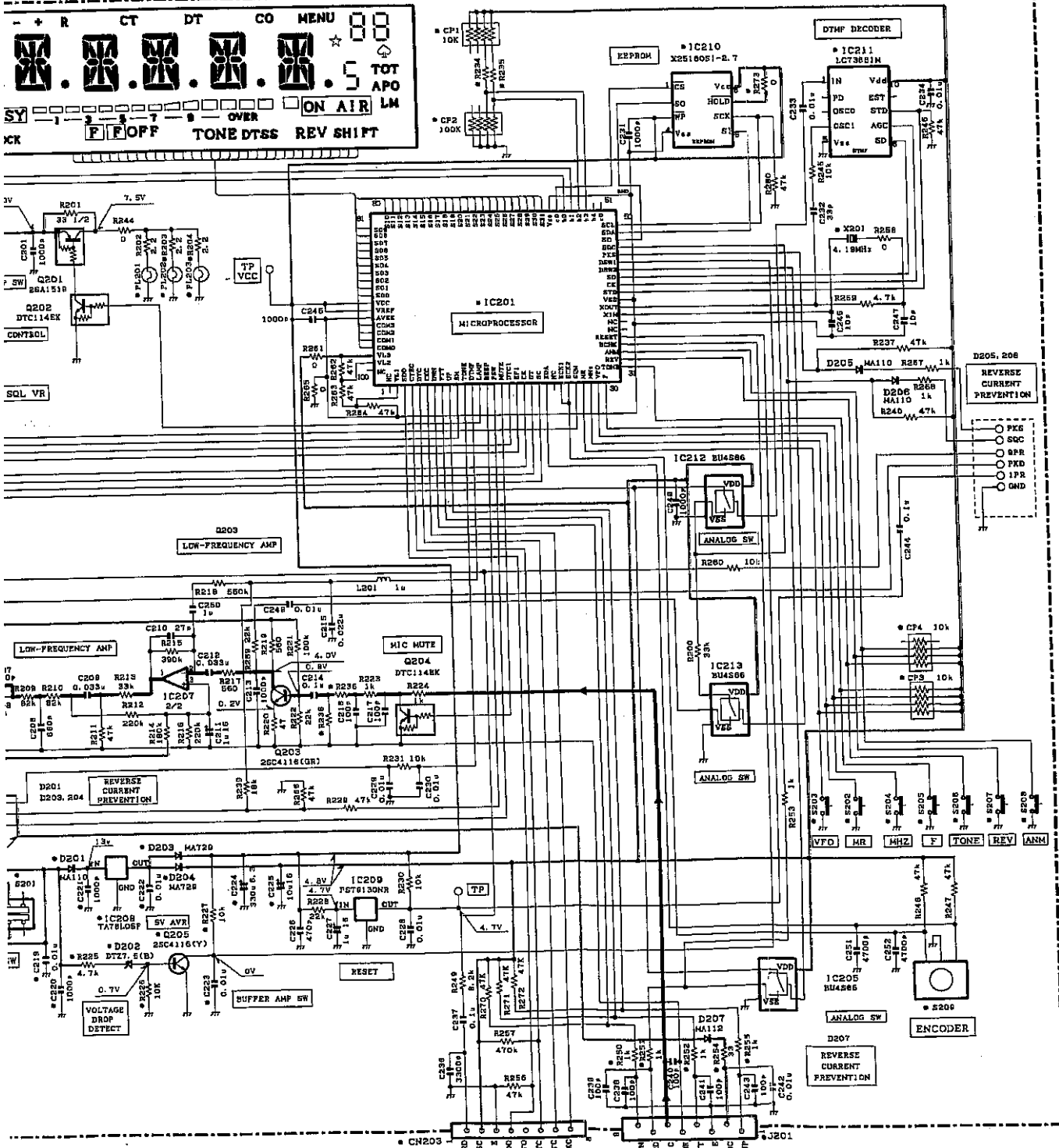

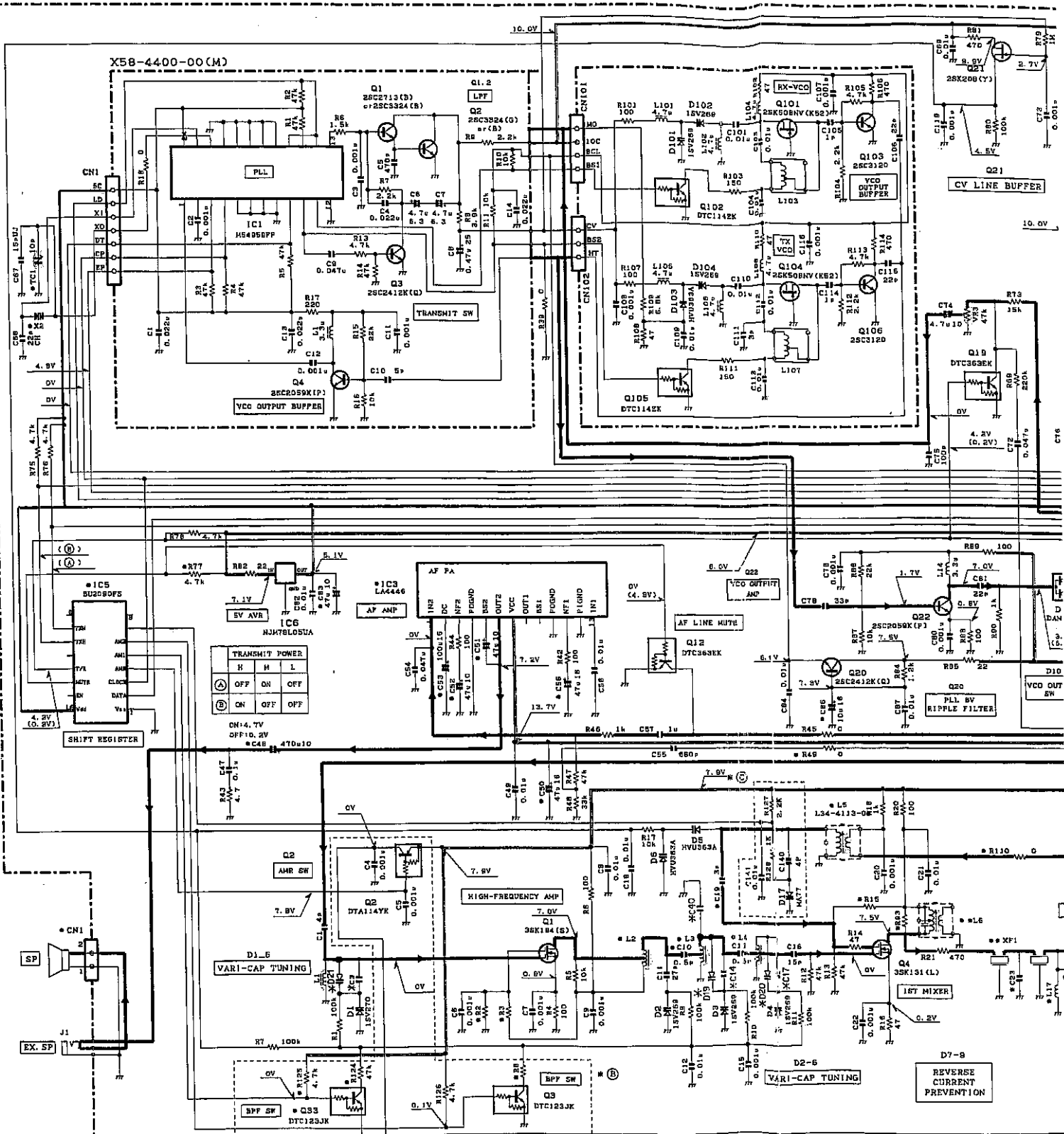

- IC1: KCD10 IC5: BU2060FS IC9: KCB11 IC30: *
- IC2: TA7787AF IC6: NJM78L05UA IC8: TA7808S Q1: 3SK184(S)
- IC3: LA4446 IC7: LA5010M IC10: BU4566 Q2: DTA114YK
- Q3, 23: DTC123JK Q4: 3SK131(L) Q7: DTC143EK
- Q5, 22: 2SC2059K(P) Q6: 2SK208(Y) Q8, 16, 18, 20, 27, 28, 30: 2SC2412K(Q)
- Q12, 19: DTC363EK

D19-21
-
-
15V269
15V269

X57-4970-XX	R2	R3	R8	R15	R19	R22	R23	R20	R39	R93	R95	R98	R100	R101	R102	R103	R104	R108	R235	R23A	R236	R238	C17	C23	C24	C26	C29	C38	C39	C65	C70	C104	C107	C108	C109	C110		
K	0-11	0	27k	-	R19	-	1k	10k	-	1k	3.9k	-	0	22 2 1/2	100 1/2	-	-	0	0	0	2.2k	3.9k	27p	5p	10k	10k	1000p	0.22u	35	1u	-	39p	22k	1000p	18p	0.5p	3p	
M	0-21	10k	270k	-	270k	0	1.5k	470	15k	0	100k	270	18	270	33 1/2	120 1/2	390k	-	-	0	820	56k	32p	5p	47k	33k	150p	0.47u	25	-	47u	16	-	2p	100p	33p	1p	2p
M2	0-22	10k	270k	-	270k	0	1.5k	470	15k	0	100k	270	18	270	33 1/2	120 1/2	270k	-	-	0	2.2k	3.9k	5p	5p	22p	33p	150p	0.68u	20	-	47u	16	-	22p	1000p	18p	0.5p	3p
M3	0-23	10k	270k	-	270k	0	1.5k	470	15k	0	100k	270	18	270	33 1/2	120 1/2	270k	-	-	0	2.2k	3.9k	5p	5p	22p	33p	150p	0.68u	20	-	47u	16	-	22p	1000p	18p	0.5p	3p

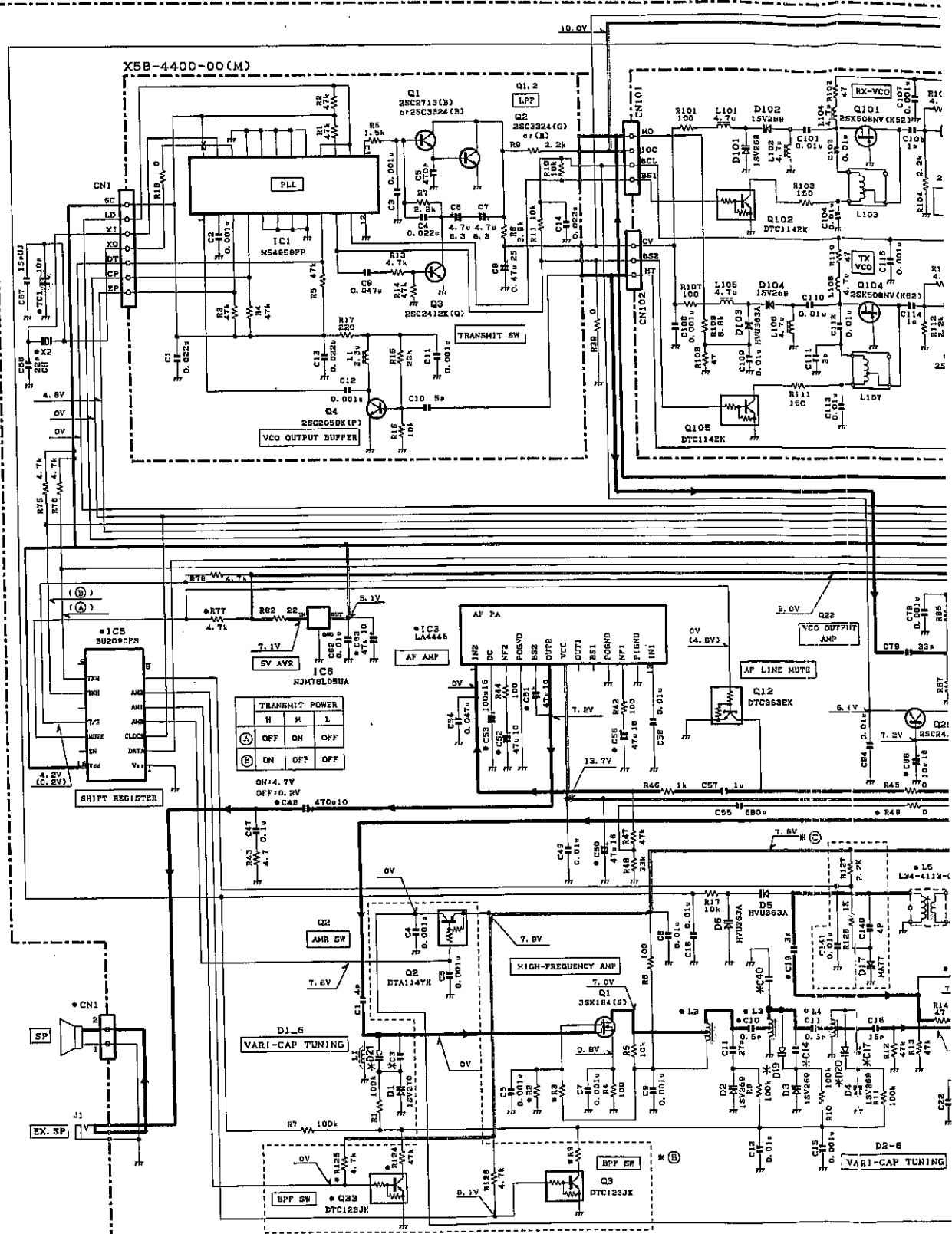

X57-497X-XX	C3	C14	C40	D19-21
K 0-11	18P	27P	-	-
M 0-21	18P	27P	-	-
M2 0-22	-	-	1.5P	15V269
M3 0-23	-	-	1.5P	15V269

IC1: KCD10	IC5: BU2060FS	IC8: KCB11	IC9: TA76D85	Q1: 3SK184(S)	Q4: 3SK131(L)	Q7: DTC1
IC2: TA7767AF	IC6: NJM18L05UA	IC9: TA76D85	IC10: BU4566	Q2: DTA114YK	Q5: 2S2C2059K(P)	Q8: 16-1
IC3: LA4446	IC7: LA5010M	IC10: BU4566		Q3: 33: DTC123JK	Q6: 2SK208(Y)	Q12: 19:

X57-4970-XX	R2	R3	R8	R15	R19	R22	R28	R30	R39	R43	R45	R48	R100	R101	R102	R103	R105	R108	R235	R234	R236	R238	C17	C23	C26	C28	C29	C36	
K 0-11	0	-	27k	-	-	-	1k	10k	-	1k	3.9k	-	0	-	22 2/2w	100 1/2w	-	-	0	-	2.2k	3.9k	27p	5p	10p	10p	1000p	0.22u	95
M 0-21	10k	270k	-	270k	0	1.5k	470	15k	0	-	100k	270	18	270	33 1/2w	120 1/2w	390k	0	-	0	920	56k	22p	5p	47p	33p	180p	0.47u	25
M2 0-22	10k	270k	-	270k	0	1.5k	470	15k	0	-	3.9k	-	0	-	22 1/2w	100 1/2w	270k	-	-	-	2.2k	3.9k	-	5p	22p	33p	150p	0.56u	20
M3 0-23	10k	270k	-	270k	0	1.5k	470	15k	0	-	3.9k	-	0	-	22 1/2w	100 1/2w	270k	-	-	-	2.2k	3.9k	-	5p	22p	33p	150p	0.56u	20