

FT-77

MARKER UNIT INSTALLATION

Requires:

One marker Unit Kit number D3000234, composed of:

One Marker Unit number C025110A

Two self-tapping screws

1. Remove the eight screws affixing the top cover, and remove the cover carefully; disconnecting the speaker leads before pulling the cover away.
2. Referring to the diagram below, mount the Marker Unit using the two screws supplied, noting in particular the location of J₉₄₀₁, which should be nearest the front panel. Use care not to trap any wires or connectors under the Unit.
3. Connect P₈₀₀₂ in the transceiver to J₉₄₀₁ on the Marker Unit.
4. Referring to the drawings below, route the output cable exactly as shown. Notice that this cable must be routed over the top of the FM Unit, if installed. Connect P₉₄₀₁ on the end of this cable to J₁₀₀₁ on the RF Unit (mounted vertically at the right side of the chassis).
5. Check and align the Marker Unit as described on page 19
6. Reconnect the speaker wires and replace the top cover and its eight screws. Installation is now complete.

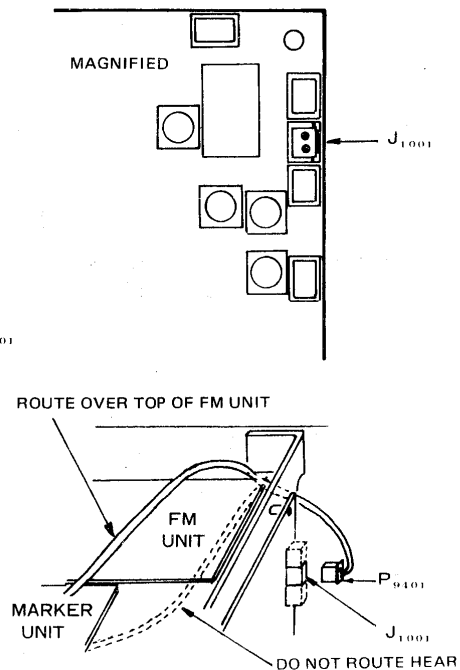
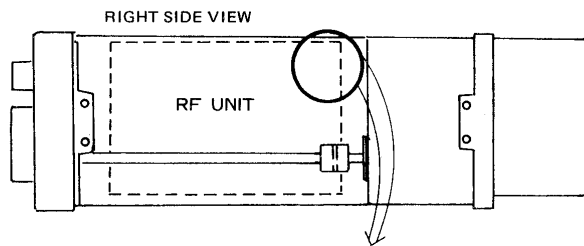
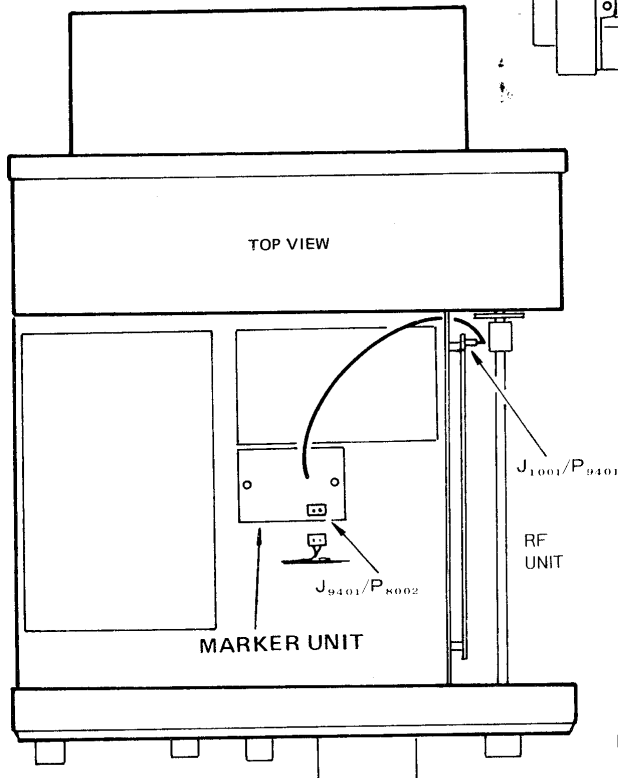

FT-77

AM UNIT INSTALLATION

Requires:

Kit number D3000277, consisting of
 One AM Unit circuit board assembly C025290A
 One cable and connector assembly T9204593
 One cable and connector assembly T9204594
 One cable and connector assembly T9204656
 Two self-tapping screws for mounting

Note: The connector plugs on the cable assemblies are marked with two numbers which correspond to the last two digits of the circuit part number; for example, P₉₆₀₁ is marked 01.

1. Remove the eight screws affixing the top cover, and remove the cover carefully; disconnecting the speaker leads before pulling the cover away.

2. Referring to the diagram below, locate the correct position for mounting the AM Unit; in particular, notice the location of jack J₉₆₀₃. With this positioned as shown in the diagram, affix the AM Unit in place with the self-tapping screws provided, while making sure that no wires or connectors are trapped beneath the Unit.

3. Locate 6-pin plug P₆₀ in the transceiver, and connect it to J₉₆₀₁ on the AM Unit, as shown in the diagram. Also, remove P₃₄ from J₃₀₁₂ on the AF Unit and connect it to J₉₆₀₄ on the AM Unit.

4. Connect the cable assembly connector plugs to the jacks on the AF Unit and AM Unit as follows:

Connect P₉₆₀₃ to J₃₀₁₃ on the AF Unit
 Connect P₉₆₀₁ to J₉₆₀₂ on the AM Unit
 Connect P₉₆₀₄ to J₃₀₀₃ on the AF Unit
 Connect P₉₆₀₂ to J₉₆₀₃ on the AM Unit
 Connect P₉₆₀₆ to J₃₀₁₂ on the AF Unit
 Connect P₉₆₀₅ to J₉₆₀₅ on the AM Unit

Double check these connections and compare with those shown in the diagram. Also note the routing of the three new cables shown in the drawing, and route these in the same way.

5. This completes the installation, place the top cover near the transceiver and reconnect the speaker wires.
6. Replace the top cover and its eight screws.

For AM operation, set the MODE selector to FM (now AM), and adjust the MIC/DRIVE control so that the ALC meter just begins to deflect.

Additional specifications for the FT-77 with the AM Unit installed are as follows:

AM TX RF Power Input: 60 W DC for 25 W RF output
 AM RX Sensitivity: 2 μV for 10 dB S+N/N

AM receiver selectivity is the same as that for SSB and CW-W.

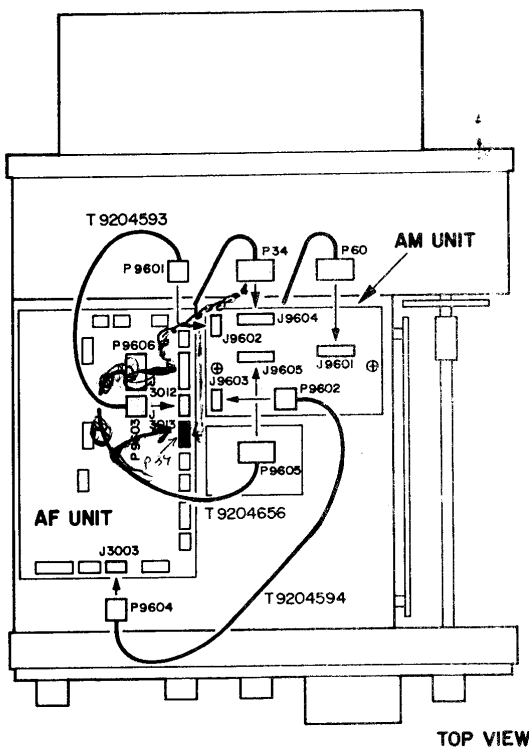

ALIGNMENT

AM UNIT (Option)

A. RX IF Buffer

Connect the signal generator to the antenna jack, and set for $2\mu\text{V}$ output at 28.000 MHz with 30% modulation at 400 Hz. Tune the transceiver to the same frequency, connect the AF voltmeter across the speaker terminals, and adjust T9601 on the AM Unit for maximum AF voltage.

B. TX Output Level

1. Connect the 50-ohm dummy load to the ANT terminal, and set the MIC/DRIVE control fully counterclockwise. Connect the RF voltmeter to pin 2 of J9601, close the PTT line, and adjust VR9603 for 60 mVrms on the meter.
2. Now connect the RF voltmeter to the cathode of D9606, close the PTT line, and adjust T9602 for maximum RF voltage.

C. AM TX Carrier Frequency

Connect the frequency counter to the cathode of D9606, close the PTT line, and adjust TC9601 for 8.988200 MHz on the counter.

D. AM Modulation

Connect the audio generator to pin 8 of the MIC jack, and set for an output of 5 mVrms at 1000 Hz (use the AF voltmeter to set the precise level, if necessary). Connect the oscilloscope to the cathode of D9606, preset VR9601 fully clockwise, and adjust VR9602 for 80% modulation while transmitting into the dummy load (see waveform A).

E. Mic Gain

Set the output level of the audio generator from the preceding step for 1.5 mVrms, and with the scope still connected as above, adjust VR9601 for 50% modulation (waveform B).

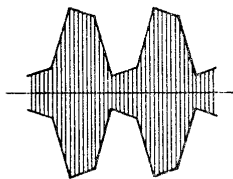

Waveform A

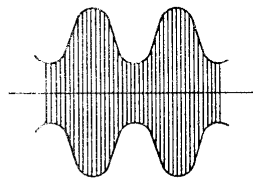

Waveform B

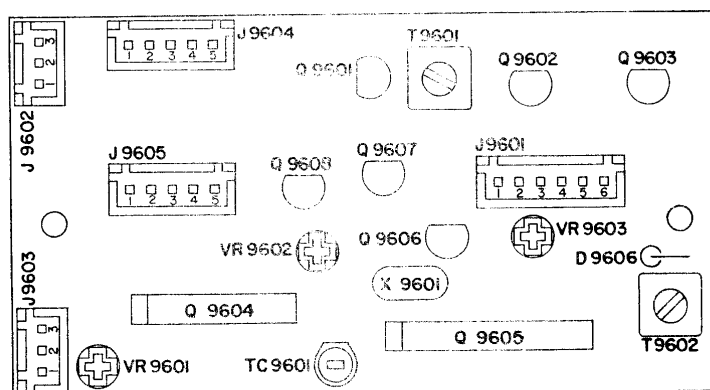

AM UNIT

Component side

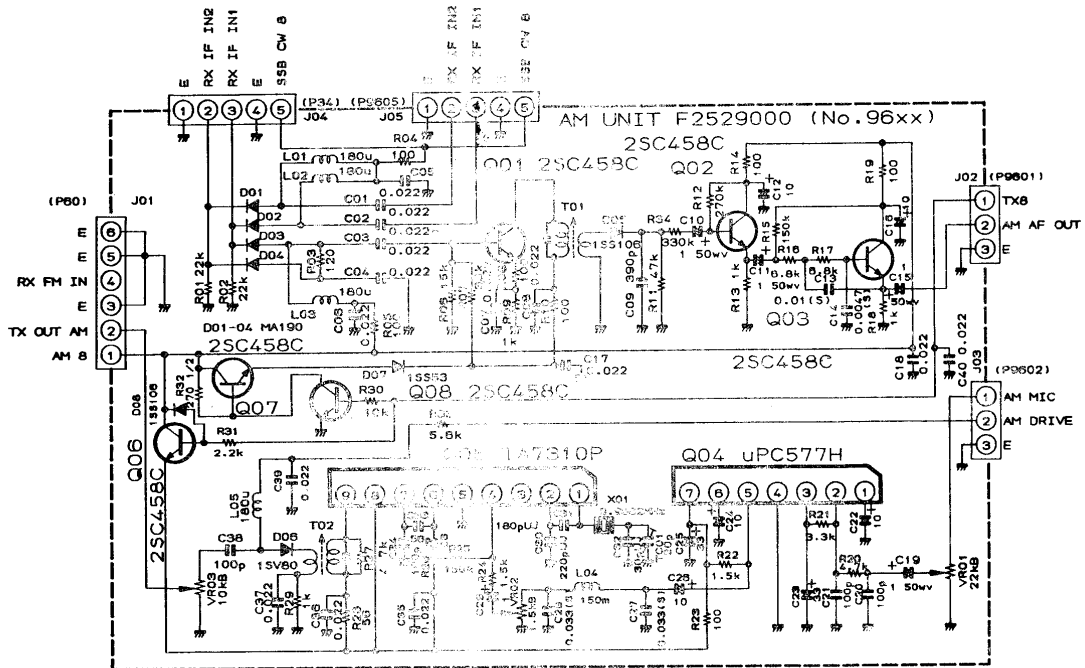
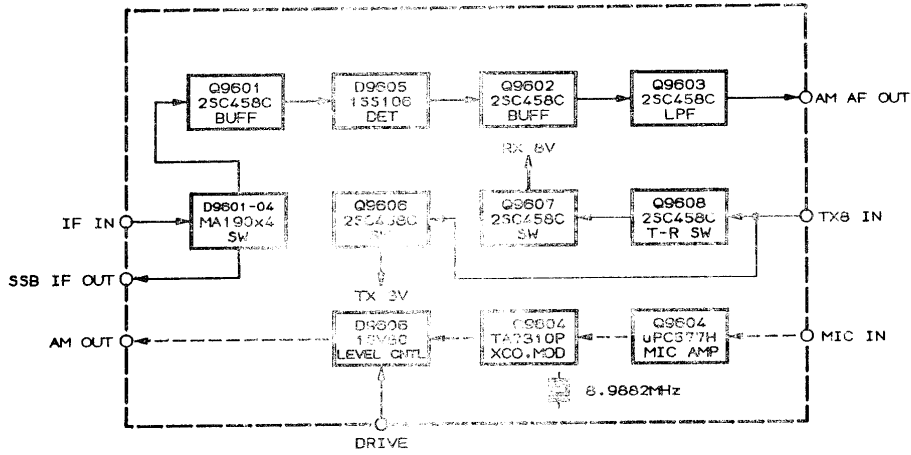

NOTE RESISTOR VALUES ARE IN OHMS, 1/4W;
 CAPACITOR VALUES ARE IN μ F, 16V;
 AND INDUCTOR VALUES ARE IN H;
 UNLESS OTHERWISE NOTED