



YAESU

Quad Band FM Transceiver

FT-8900R

Technical Supplement

© 2002 VERTEX STANDARD CO., LTD. (EH008M90A)

VERTEX STANDARD CO., LTD.
 4-8-8 Nakameguro, Meguro-Ku, Tokyo 153-8644, Japan

VERTEX STANDARD
US Headquarters
 10900 Walker Street, Cypress, CA 90630, U.S.A.
International Division
 8350 N.W. 52nd Terrace, Suite 201, Miami, FL 33166, U.S.A.

YAESU EUROPE B.V.
 P.O. Box 75525, 1118 ZN Schiphol, The Netherlands

YAESU UK LTD.
 Unit 12, Sun Valley Business Park, Winnall Close
 Winchester, Hampshire, SO23 0LB, U.K.

VERTEX STANDARD HK LTD.
 Unit 5, 20/F., Seaview Centre, 139-141 Hoi Bun Road,
 Kwun Tong, Kowloon, Hong Kong

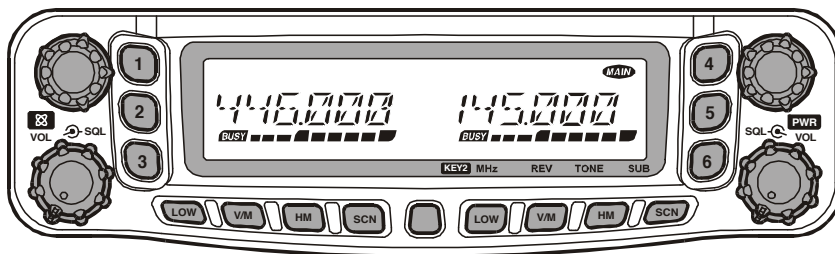

Downloaded by
RadioAmateur.EU

Introduction

This manual provides technical information necessary for servicing the FT-8900R Transceiver.

Servicing this equipment requires expertise in handling surface-mount chip components. Attempts by non-qualified persons to service this equipment may result in permanent damage not covered by the warranty, and may be illegal in some countries.

Two PCB layout diagrams are provided for each double-sided circuit board in the transceiver. Each side of the board is referred to by the type of the majority of components installed on that side ("leaded" or "chip-only"). In most cases one side has only chip components, and the other has either a mixture of both chip and leaded components (trimmers, coils, electrolytic capacitors, ICs, etc.), or leaded components only.

While we believe the technical information in this manual to be correct, Vertex Standard assumes no liability for damage that may occur as a result of typographical or other errors that may be present. Your cooperation in pointing out any inconsistencies in the technical information would be appreciated.

Contents

Specifications	2	Board Unit (Schematics, Layouts & Parts)	
Exploded View & Miscellaneous Parts	3	Main Unit	17
Connection Diagram	4	Panel Unit	47
Circuit Description	5	Panel-Sub Unit	53
Alignment	11	VR-L Unit	55
		VR-R Unit	56

Specifications

GENERAL

Frequency Range:	RX: 28.000 - 29.700 MHz, 50.000 - 54.000 MHz, 108.000 - 180.000 MHz, 320.000 - 480.000 MHz, 700 - 985 MHz (Cellular Blocked)
	TX: 28.000 - 29.700 MHz, 50.000 - 54.000 MHz, 144.000 - 146.000 MHz (or 144.000 - 148.000 MHz), 430.000 - 440.000 MHz (or 430.00 - 450.000 MHz)
Channel Steps:	5/10/12.5/15/20/25/50 kHz
Modes of Emission:	F3, F2, F1
Antenna Impedance:	50-Ohms, unbalanced (Antenna Duplexer built-in)
Frequency Stability:	±5 ppm @ 14° F ~ +140° F (-10 °C ~ +60 °C)
Operating Temperature Range:	-4° F ~ +140° F (-20 °C ~ +60 °C)
Supply Voltage:	13.8 VDC (±15%), negative ground
Current Consumption (Approx.):	RX: 0.5 A (Squelched) TX: 8.0 A (50/430 MHz), 8.5 A (29/144 MHz)
Case Size (W x H x D):	5.5" x 1.6" x 6.6" (140 x 41.5 x 168 mm) (w/o knobs & connectors)
Weight (Approx.):	2.2 lb (1 kg)

TRANSMITTER

Output Power:	50/20/10/5 W (29/50/144 MHz), 35/20/10/5 W (430 MHz)
Modulation Type:	Variable Reactance
Maximum Deviation:	±5 kHz (50/144/430 MHz), ±2.5 kHz (29 MHz)
Spurious Radiation:	Better than -60 dB (29 MHz: Better than -50 dB)
Modulation Distortion:	Less than 3%
Microphone Impedance:	2 kΩ
DATA Jack Impedance:	10 kΩ

RECEIVER

Circuit Type:	Double-conversion superheterodyne
Intermediate Frequencies:	45.05 MHz/450 kHz (Left band), 47.25 MHz/450 kHz (Right band)
Sensitivity (for 12dB SINAD):	Better than 0.2 μV
Squelch Sensitivity:	Better than 0.16 μV
Selectivity (-6dB/-60dB):	8 kHz/30 kHz (50/144/430 MHz), 6 kHz/30 kHz (29 MHz)
Maximum AF Output:	2 W @ 8 Ω for 5% THD
AF Output Impedance:	4-16 Ω

Specifications are subject to change without notice, and are guaranteed within the 29, 50, 144, and 430 MHz amateur bands only. Frequency ranges will vary according to transceiver version; check with your dealer.

Exploded View & Miscellaneous Parts

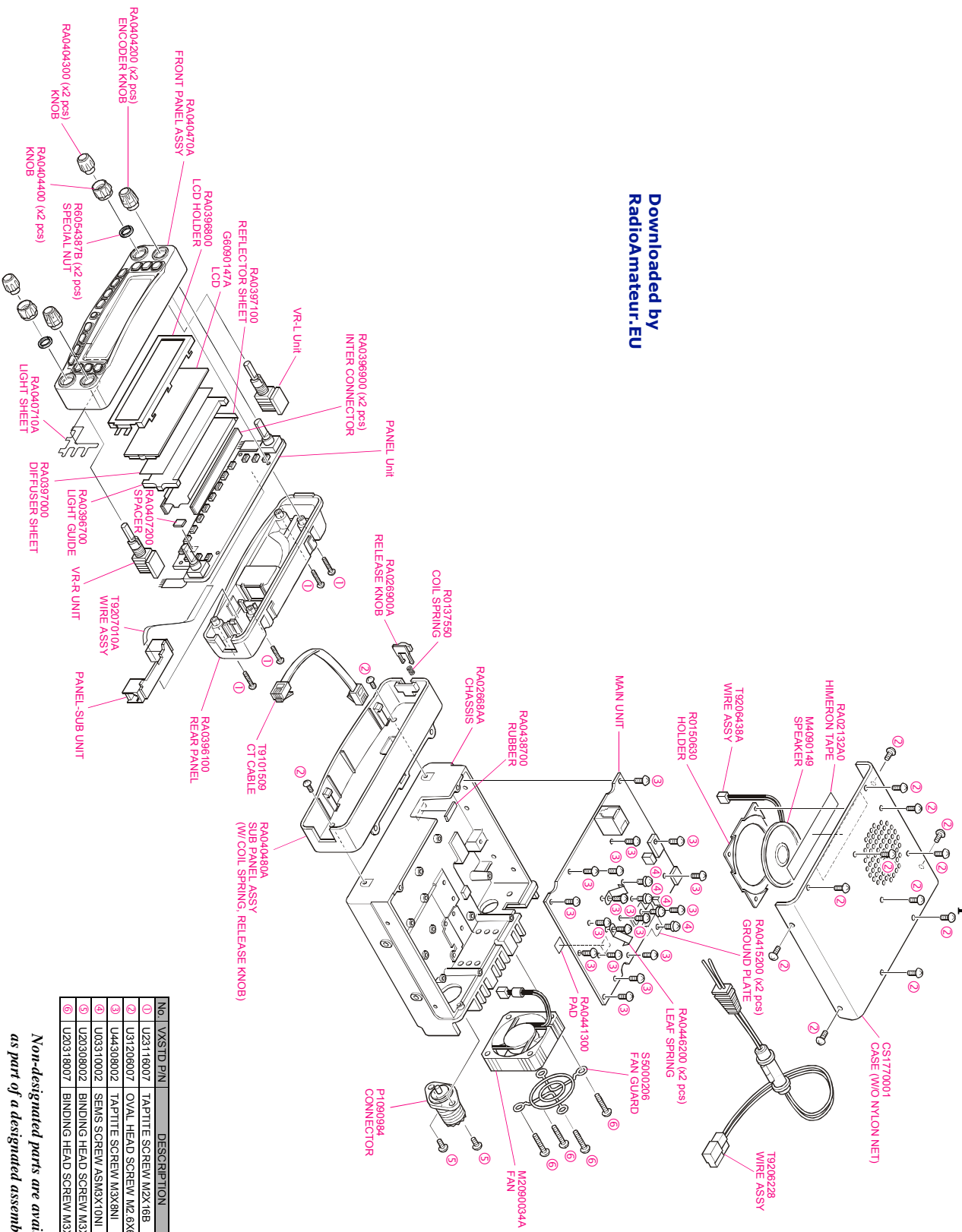

No.	UNSTD. P/N	DESCRIPTION	QTY
①	U23116007	TAPITTE SCREW M2X16B	4
②	U31209007	OVAL HEAD SCREW M2.6X6B	14
③	U44309002	TAPITTE SCREW M3X8NI	17
④	U03310002	SEMS SCREW ASM3X10NI	4
⑤	U20309002	BINDING HEAD SCREW M3X8NI	2
⑥	U20319007	BINDING HEAD SCREW M3X18B	4

Non-designated parts are available only as part of a designated assembly.

Connection Diagram

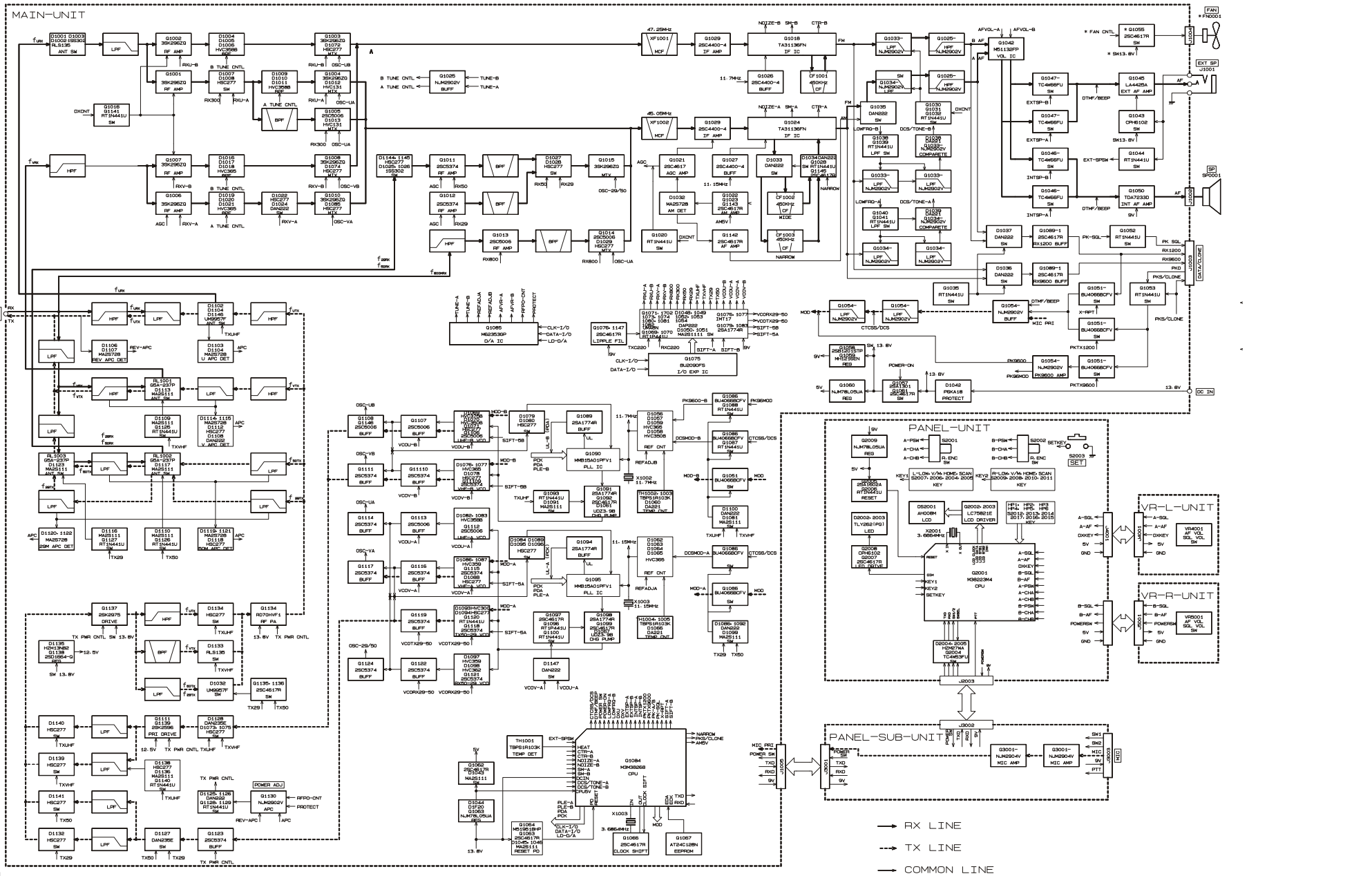

Receiver Signal Path

“Left” Band 430 MHz Signal

The 430 MHz signal is passed through a high-pass filter network and a low-pass filter network to the antenna switch diodes **D1001/D1002** (both **RLS135**), then passed through another low-pass filter network to the “Left” band RF amplifier **Q1001 (3SK296ZQ)**.

The amplified 430 MHz signal is passed through the band switch **D1008 (HSC277)** to the varactor-tuned band-pass filter network consisting of **D1009, D1010, D1011** (all **HVC358B**) and associated circuitry, then applied to the first mixer **Q1004 (3SK296ZQ)**. Meanwhile, the UHF local signal from the UHF-VCO/A **Q1112 (2SC5006)** is delivered to first mixer **Q1004**, yielding the 45.05 MHz “Left” band first IF.

“Left” Band 144 MHz Signal

The 144 MHz signal is passed through a low-pass filter network and a high-pass filter network to the antenna switching relay **RL1001 (G5A-237P)**, then passed through another high-pass filter network and low-pass filter network to the “Left” band RF amplifier **Q1006 (3SK296ZQ)**.

The amplified 144 MHz signal is passed through a varactor-tuned band-pass filter network consisting of **D1019, D1020, D1021** (all **HVC365**) and associated circuitry to the first mixer **Q1010 (3SK296ZQ)**. Meanwhile, the VHF local signal from the VHF-VCO/A **Q1115 (2SC5374)** is delivered to first mixer **Q1010**, yielding the 45.05 MHz “Left” band first IF.

“Left” Band 50 MHz Signal

The 50 MHz signal is passed through a low-pass filter network and antenna switching relay **RL1003 (G5A-237P)**, then passed through another low-pass filter network, antenna switch relay **RL1002 (G5A-237P)**, and band switch diode **D1144 (HSC277)** to yet another low-pass filter network, then applied to the “Left” band RF amplifier **Q1006 (3SK296ZQ)**.

The amplified 50 MHz signal is passed through a band-pass filter network and band switch diode **D1027 (HSC277)** to the first mixer **Q1015 (3SK296ZQ)**. Meanwhile, the 50 MHz local signal from the RX50-29-VCO **Q1121 (2SC5374)** is delivered to first mixer **Q1015**, yielding the 45.05 MHz “Left” band first IF.

“Left” Band 28 MHz Signal

The 28 MHz signal is passed through a low-pass filter network and antenna switching relay **RL1003 (G5A-237P)**, then passed through another low-pass filter network, antenna switching relay **RL1002 (G5A-237P)** and band switch diode **D1144 (HSC277)** to yet another low-pass filter network, then delivered to the “Left” band RF amplifier **Q1012 (2SC5374)**.

The amplified 28 MHz signal is passed through a band-pass filter network and band switch diode **D1028 (HSC277)** to the first mixer **Q1015 (3SK296ZQ)**. Meanwhile, the 28 MHz local signal from the RX50-29-VCO **Q1121** is delivered to first mixer **Q1012**, yielding the 45.05 MHz “Left” band first IF.

“Left” Band IF and AF Signals

The 45.05 MHz “Left” band first local signal is delivered to the monolithic crystal filter **XF1002** which strips away unwanted mixer products, then is passed through IF amplifier **Q1019 (2SC4400)** to the IF IC **Q1024 (TA31136FN)**.

Meanwhile, a portion of the output of 11.15 MHz crystal **X1003** is multiplied fourfold by **Q1027 (2SC4400)** to provide the 44.6 MHz second local signal, then delivered to the IF IC **Q1024**. Within the IF IC **Q1024**, the 44.6 MHz second local signal is mixed with the 45.05 MHz “Left” band first local signal to produce the 450 kHz “Left” band second IF.

The 450 kHz “Left” band second IF is passed through the filter switch **D1033/D1034** (both **DAN235E**) to the ceramic filter **CF1002 (CFWM450E)** which strips away all but the desired signal, then it passes through the IF amplifier within **Q1024** to the ceramic discriminator **CD1002 (CDBM450C24)**, which removes any amplitude variations in the 450 kHz IF signal before detection of speech.

The demodulated “Left” band audio is passed through the de-emphasis network, audio switch **D1035 (DAN222)**, low-pass filter network (consisting of **Q1034 (NJM2902V)** and associated circuitry), and a high-pass filter network (consisting of **Q1025 (NJM2092V)** and associated circuitry). The filtered audio signal is passed through the audio volume control IC **Q1042 (M511312FP)**, which adjusts the audio sensitivity to compensate for audio level variations, then is delivered to the audio switch **Q1046** and **Q1047** (both **TC4W66FU**).

When the internal speaker is selected, the audio signal is amplified by **Q1050 (TDA7233D)** then applied to the internal loudspeaker. When the external speaker is selected, the audio signal is amplified by **Q1045 (LA4425A)**, then it passes through the EXT SP jack to the external loudspeaker.

“Right” Band 430 MHz Signal

The 430 MHz signal is passed through a high-pass filter network and a low-pass filter network to the antenna switch diodes **D1001/D1002**, then passed through another low-pass filter network to the “Right” band RF amplifier **Q1002 (3SK296ZQ)**.

The amplified 430 MHz signal is delivered through the band switch **D1008 (HSC277)** to the varactor-tuned band-pass filter network consisting of **D1004, D1005, D1006** (all **HVC358B**) and associated circuitry, then applied to the

Circuit Description

first mixer **Q1003 (3SK296ZQ)**. Meanwhile, the UHF local signal from the UHF-VCO/B **Q1106 (2SC5006)** is delivered to first mixer **Q1004**, yielding the 47.25 MHz “Right” band first IF.

“Right” Band 144 MHz Signal

The 144 MHz signal is passed through a low-pass filter network and a high-pass filter network to the antenna switching relay **RL1001 (G5A-237P)**, then passed through another high-pass filter network and low-pass filter network to the “Right” band RF amplifier **Q1007 (3SK296ZQ)**.

The amplified 144 MHz signal is passed through the varactor-tuned band-pass filter network consisting of **D1016, D1017, D1018** (all **HVC365**) and associated circuitry to the first mixer **Q1008 (3SK296ZQ)**. Meanwhile, the VHF local signal from the VHF-VCO/B **Q1109 (2SC5374)** is delivered to first mixer **Q1008**, yielding the 47.25 MHz “Right” band first IF.

“Right” Band IF and AF Signal

The 47.25 MHz “Right” band first IF is delivered to the monolithic crystal filter **XF1001** which strips away unwanted mixer products, then passed through the IF amplifier **Q1017 (2SC4400)** to the IF IC **Q1018 (TA31136FN)**.

Meanwhile, a portion of the output of 11.7 MHz crystal **X1002** is multiplied fourfold by **Q1026 (2SC4400)** to provide the 46.8 MHz second local signal, then applied to the IF IC **Q1018**. Within the IF IC **Q1018**, the 46.8 MHz second local signal is mixed with the 47.25 MHz “Right” band first local signal to produce the 450 kHz “Right” band second IF.

The 450 kHz “Right” band second IF is delivered to the ceramic filter **CF1001 (CFWM450E)** which strips away all but the desired signal, then passed through the IF amplifier within **Q1018** to the ceramic discriminator **CD1001 (CDBM450C24)** which removes any amplitude variations in the 450 kHz IF signal before detection of speech.

The demodulated “Right” band audio is passed through the de-emphasis network, low-pass filter network (consisting of **Q1033 (NJM2902V)** and associated circuitry) and the high-pass filter network (consisting of **Q1025 (NJM2092V)** and associated circuitry). The filtered audio signal is passed through the audio volume control IC **Q1042 (M511312FP)**, which adjusts the audio sensitivity to compensate for audio level variations, then is delivered to the audio switch **Q1046** and **Q1047** (both **TC4W66FU**).

When the internal speaker is selected, the audio signal is amplified by **Q1050 (TDA7233D)** then applied to the internal loudspeaker. When the external speaker is selected, the audio signal is amplified by **Q1045 (LA4425A)**, then it passes through the **EXT SP** jack to the external loudspeaker.

Squelch Control

“Left” Band

When no carrier is being received on the “Left” band, noise at the output of the detector stage in **Q1024** is amplified and band-pass filtered by the noise amp section of **Q1024**. The resulting DC voltage is delivered to pin 2 of main CPU **Q1084 (M38268MCL)**, which compares the squelch threshold level to that which set by the front panel **SQL** knob.

While no carrier is being received on the “Left” band, pins 43 and 45 of **Q1084** remain “low,” to disable the audio switch **Q1046/Q1047**, thus disabling the audio output from the speaker.

“Right” Band

When no carrier is being received on the “Right” band, noise at the output of the detector stage in **Q1018** is amplified and band-pass filtered by the noise amp section of **Q1018**. The resulting DC voltage is delivered to pin 5 of main CPU **Q1084**, which compares the squelch threshold level to that which set by the front panel **SQL** knob.

While no carrier is being received on the “Left” band, pins 42 and 44 of **Q1084** remain “low,” to disable the audio switch **Q1046** and **Q1047**, thus disabling the audio output from the speaker.

Transmitter Signal Path

AF Signal

The speech signal from the microphone is passed through the **MIC** jack **J3003** to the AF amplifier **Q3001 (NJM2904V)** on the **PANEL-SUB** UNT. The amplified speech signal is passed through the panel separation jacks **J3001** and **J1005** to the **MAIN** Unit. On the **MAIN** UNIT, the speech signal is delivered to the limiting amplifier **Q1054 (NJM2902V)** to prevent over-modulation, then is delivered to a low-pass filter network consisting of **Q1054** and associated circuitry.

430 MHz Signal

The adjusted speech signal from **Q1054** is passed through transistor switch **Q1051 (BU4066BCFV)** to varactor diodes **D1069 (HVC375)** and **D1070 (HVC350B)**, which frequency modulate the transmitting VCO, made up of UHF-VCO/B **Q1106 (2SC5006)** and **D1071 (HSC277)**.

The modulated transmit signal is passed through buffer amplifiers **Q1107, Q1108, and Q1146** (all **2SC5006**) and diode switches **D1073 (HSC277)** and **D1128 (DAN235E)** to the pre-drive amplifier **Q1139 (2SK2596)**.

The amplified transmit signal from **Q1139** is passed through diode switch **D1134 (HSC277)** and the driver amplifier **Q1137 (2SK2975)** to the diode switch **D1134 (HSC277)**, then finally amplified by power amplifier

Circuit Description

Q1134 (RD70HVF1), providing up to 35 Watts of power output. These three stages of the power amplifier's gain are controlled by the APC circuit.

The 35-Watt RF signal is passed through a high-pass filter network to the antenna switch **D1102**, **D1104**, and **D1146** (all **UM9957F**), then passed through a low-pass filter network and another high-pass filter network to the ANT jack.

144 MHz Signal

The adjusted speech signal from Q1054 is passed through the transistor switch **Q1051 (BU4066BCFV)** to varactor diodes **D1076** and **D1077** (both **HVC365**), which frequency modulate the transmitting VCO, made up of VHF-VCO/B **Q1109 (2SC5374)** and **D1078 (HSC277)**.

The modulated transmit signal is passed through buffer amplifiers **Q1100** and **Q1111** (both **2SC5374**) and diode switches **D1075 (HSC277)** and **D1128 (DAN235E)** to the pre-drive amplifier **Q1139 (2SK2596)**.

The amplified transmit signal from **Q1139** is passed through the diode switch **D1139/D1140** (both **HSC277**) and the driver amplifier **Q1137 (2SK2975)** to diode switch **D1133 (RLS135)**, then finally amplified by power amplifier **Q1134 (RD70HVF1)** up to 50 Watts of power output. These three stages of the power amplifier's gain are controlled by the APC circuit.

The 50-Watt RF signal is passed through a low-pass filter network to the antenna switching relay **RL1001 (G5A-237P)**, then passed through a high-pass filter network and another low-pass filter network to the ANT jack.

50 MHz Signal

The adjusted speech signal from Q1054 is passed through transistor switch **Q1086 (BU4066BCFV)** to varactor diode **D1093 (HVC300A)**, which frequency modulates the transmitting VCO, made up of TX50-29-VCO **Q1118 (2SC5374)** and **D1094 (HSC277)**.

The modulated transmit signal is passed through buffer amplifier **Q1119 (2SC5374)** to the pre-Drive amplifier **Q1123 (2SC5374)**.

The amplified transmit signal from **Q1123** is passed through diode switches **D1127 (DAN235E)** and **D1141 (HSC277)** and driver amplifier **Q1137 (2SK2975)** to diode switch **D1132 (D1F20)**, then finally amplified by power amplifier **Q1134 (RD70HVF1)** up to 50 Watts of power output. These three stages of the power amplifier's gain are controlled by the APC circuit.

The 50-Watt RF signal is passed through antenna switching relay **RL1002 (G5A-237P)** to a low-pass filter network, then passed through antenna switching relay **RL1003 (G5A-237P)** and another low-pass filter network to the ANT jack.

28 MHz Signal

The adjusted speech signal from **Q1054** is passed through transistor switch **Q1086 (BU4066BCFV)** to varactor diode **D1093 (HVC300A)**, which frequency modulates the transmitting VCO, made up of TX50-29-VCO **Q1118 (2SC5374)** and **D1094 (HSC277)**.

The modulated transmit signal is passed through buffer amplifier **Q1119 (2SC5374)** to the pre-Drive amplifier **Q1123 (2SC5374)**.

The amplified transmit signal from **Q1123** is passed through diode switches **D1127 (DAN235E)** and **D1142 (HSC277)** and driver amplifier **Q1137 (2SK2975)** to diode switch **D1132 (D1F20)**, then finally amplified by power amplifier **Q1134 (RD70HVF1)** up to 50 Watts of output power. These three stages of the power amplifier's gain are controlled by the APC circuit.

The 50-Watt RF signal is passed through antenna switching relay **RL1002 (G5A-237P)** to a low-pass filter network, then passed through antenna switching relay **RL1003 (G5A-237P)** and another low-pass filter network to the ANT jack.

APC (Automatic Power Control) Circuit

430 MHz

A portion of the power amplifier output is rectified by **D1103** and **D1105** (both **MA2S728**) then delivered to APC **Q1130 (NJM2904V)**, as a DC voltage which is proportional to the output level of the power amplifier.

At **Q1130**, the rectified DC voltage from the power amplifier is compared to the reference voltage from the main CPU **Q1084** to produce a control voltage, which regulates the supply voltage to the pre-drive amplifier **Q1139 (2SK5396)**, driver amplifier **Q1137 (2SK2975)**, and power amplifier **Q1134 (RD70HVF1)**, so as to maintain stable output power under varying antenna loading conditions.

144 MHz

A portion of the power amplifier output is rectified by **D1114** and **D1115** (both **MA2S728**) then delivered to APC **Q1130 (NJM2904V)**, as a DC voltage which is proportional to the output level of the power amplifier.

At **Q1130**, the rectified DC voltage from the power amplifier is compared to the reference voltage from the main CPU **Q1084** to produce a control voltage, which regulates the supply voltage to the pre-drive amplifier **Q1139 (2SK5396)**, driver amplifier **Q1137 (2SK2975)**, and power amplifier **Q1134 (RD70HVF1)**, so as to maintain stable output power under varying antenna loading conditions.

50 MHz

A portion of the power amplifier output is rectified by **D1119** and **D1121** (both **MA2S728**) then delivered to APC

Circuit Description

Q1130 (**NJM2904V**), as a DC voltage which is proportional to the output level of the power amplifier.

At Q1130, the rectified DC voltage from the power amplifier is compared to the reference voltage from the main CPU Q1084 to produce a control voltage, which regulates supply voltage to the pre-drive amplifier Q1123 (**2SK5374**), driver amplifier Q1137 (**2SK2975**), and power amplifier Q1134 (**RD70HVF1**), so as to maintain stable output power under varying antenna loading conditions.

29 MHz

A portion of the Power amplifier output is rectified by D1120 and D1122 (both **MA2S728**) then delivered to APC Q1130 (**NJM2904V**), as a DC voltage which is proportional to the output level of the power amplifier.

At Q1130, the rectified DC voltage from the power amplifier is compared to the reference voltage from the main CPU Q1084 to produce a control voltage, which regulates supply voltage to the pre-drive amplifier Q1123 (**2SK5374**), driver amplifier Q1137 (**2SK2975**), and power amplifier Q1134 (**RD70HVF1**), so as to maintain stable output power under varying antenna loading conditions.

PTT (Push to Talk) Circuit

430 MHz

When the PTT switch is pressed, pin 8 of sub CPU Q2001 (**M38223E4HP**) goes “high,” which sends the “PTT” command to main CPU Q1084.

When the “PTT” command is received, the main CPU controls the I/O IC Q1075 (**BU2090FS**), causing pin 12 of Q1075 to go “low” which activates the UHF TX switch section of Q1076 (**IMT17**).

When the UHF TX switch section of Q1076 is activated, it controls the antenna switch diodes D1102, D1104, and D1146 (all **UM9957F**), modulator switching diode D1100 (**DAN222**), modulator switching IC Q1051 (**BU4066BCFV**), diode switches D1073 (**HSC277**), D1128 (**DAN235E**), D1140 (**HSC277**), and D1134 (**HSC277**), and APC switches Q1128 (**RT1N441U**) and Q1129 (**RT1P441U**), which activate the 430 MHz transmitter circuit.

144 MHz

When the PTT switch is pressed, pin 8 of sub CPU Q2001 (**M38223E4HP**) goes “high,” which sends the “PTT” command to main CPU Q1084.

When the “PTT” command is received, the main CPU controls the I/O IC Q1075 (**BU2090FS**), causing pin 13 of Q1075 to go “low” which activates the VHF TX switch section of Q1076 (**IMT17**).

When the VHF TX switch section of Q1076 is activated, it controls the antenna switching relay RL1001 (**G5A-237P**), modulator switching diode D1100 (**DAN222**), modulator

switching IC Q1051 (**BU4066BCFV**), diode switches D1075 (**HSC277**), D1128 (**DAN235E**), D1139 (**HSC277**), and D1133 (**RSL135**), and APC switches Q1128 (**RT1N441U**) and Q1129 (**RT1P441U**), which activate the 144 MHz transmitter circuit.

50 MHz

When the PTT switch is pressed, pin 8 of sub CPU Q2001 (**M38223E4HP**) goes “high,” which sends the “PTT” command to the main CPU Q1084.

When the “PTT” command is received, the main CPU controls the I/O IC Q1075 (**BU2090FS**), causing pin 14 of Q1075 to go “low” which activates the TX50 switch section of Q1077 (**IMT17**).

When the TX50 switch section of Q1076 is activated, it controls the antenna switching relay RL1002 (**G5A-237P**), modulator switching diode D1092 (**DAN222**), modulator switching IC Q1086 (**BU4066BCFV**), diode switches D1127 (**DAN235E**), D1141 (**HSC277**), and D1132 (**D1F20**), and APC switches Q1128 (**RT1N441U**) and Q1129 (**RT1P441U**), which activate the 50 MHz transmitter circuit.

28 MHz

When the PTT switch is pressed, pin 8 of sub CPU Q2001 (**M38223E4HP**) goes “high,” which sends the “PTT” command to the main CPU Q1084.

When the “PTT” command is received, the main CPU controls the I/O IC Q1075 (**BU2090FS**), causing pin 15 of Q1075 to go “low” which activates the TX29 switch section of Q1077 (**IMT17**).

When the TX29 switch section of Q1076 is activated, it controls the antenna switching relay RL1003 (**G5A-237P**), modulator switching diode D1092 (**DAN222**), modulator switching IC Q1086 (**BU4066BCFV**), diode switches D1127 (**DAN235E**), D1142 (**HSC277**), and D1132 (**D1F20**), and APC switches Q1128 (**RT1N441U**) and Q1129 (**RT1P441U**), which activate the 28 MHz transmitter circuit.

PLL Circuit

“Left” band

A portion of the output from UHF-VCO/A Q1112 (**2SC5006**) is passed through buffer amplifier Q1113 (**2SC5374**) and diode switch D1084 (**HSC277**) to the programmable divider section of the PLL IC Q1095 (**MB15A02PFV1**), where it is divided according to the frequency dividing data associated with the operating frequency input from the main CPU Q1084. It is then sent to the phase comparator.

A portion of the output from the VHF-VCO/A Q1115 (**2SC5374**) is passed through buffer amplifier Q1116 (**2SC5374**) and diode switch D1089 (**HSC277**) to the programmable divider section of the PLL IC Q1095, where it

Circuit Description

is divided according to the frequency dividing data associated with the operating frequency input from the main CPU **Q1084**. It is then sent to the phase comparator.

A portion of the output from the TX50-29-VCO **Q1118 (2SC5374)** is passed through buffer amplifier **Q1119 (2SC5374)** and diode switch **D1096 (HSC277)** to the programmable divider section of the PLL IC **Q1095**, where it is divided according to the frequency dividing data associated with the operating frequency input from the main CPU **Q1084**. It is then sent to the phase comparator.

A portion of the output from the RX50-29-VCO **Q1121 (2SC5374)** is passed through buffer amplifier **Q1122 (2SC5374)** and diode switch **D1096** to the programmable divider section of the PLL IC **Q1095**, where it is divided according to the frequency dividing data associated with the operating frequency input from the main CPU **Q1084**. It is then sent to the phase comparator.

The 11.15 MHz reference oscillator **X1003** frequency is divided by the reference frequency divider section of **Q1095** into 2230 or 1784 parts, to become 5 kHz or 6.25 kHz comparative reference frequencies, which are utilized by the phase comparator.

The phase comparator section of **Q1095** compares the phase between the frequency-divided oscillation frequency of the VCO circuit and the comparative frequency, and its output is a pulse corresponding to the phase difference. This pulse is integrated by the charge pump consisting of **D1067 (UDZS5.1B)**, **Q1098 (2SA1774)**, **Q1099 (2SC4617)**, and loop filter into a control voltage (VCV) to control the oscillation frequency of the VCOs.

“Right” band

A portion of the output from the UHF-VCO/B **Q1106 (2SC5006)** is passed through buffer amplifier **Q1107 (2SC5006)** and diode switch **D1079 (HSC277)** to the programmable divider section of the PLL IC **Q1090 (MB15A02PFV1)**, where it is divided according to the frequency dividing data associated with the operating frequency input from the main CPU **Q1084**. It is then sent to the phase comparator.

A portion of the output from the VHF-VCO/B **Q1109 (2SC5374)** is passed through buffer amplifier **Q1110 (2SC5374)** and diode switch **D1080 (HSC277)** to the programmable divider section of the PLL IC **Q1090**, where it is divided according to the frequency dividing data associated with the operating frequency input from the main CPU **Q1084**. It is then sent to the phase comparator.

The 11.70 MHz reference oscillator **X1002** frequency is divided by the reference frequency divider section of **Q1090** into 2340 or 1872 parts to become 5 kHz or 6.25 kHz comparative reference frequencies, which are utilized by the phase comparator.

The phase comparator section of **Q1090** compares the phase between the frequency-divided oscillation frequency of the VCO circuit and the comparative frequency, and its output is a pulse corresponding to the phase difference. This pulse is integrated by the charge pump consisting of **D1061 (UDZS5.1B)**, **Q1091 (2SA1774)**, **Q1092 (2SC4617)**, and loop filter into a control voltage (VCV) to control the oscillation frequency of the VCOs.

Power Supply Line

When the user presses and holds in the “Left” VOL knob for 2 seconds, pin 23 of the main CPU **Q1084** goes “low” and pin 39 of main CPU **Q1084** goes “high,” which activates the power switch **Q1057 (2SB1301)**, **Q1061 (2SC4617)**, and **Q1062 (2SA1774)**, to supply 13.8 VDC to each circuit in the transceiver.

Note

Introduction and Precautions

The **FT-8900R** has been carefully aligned at the factory for the specified performance across the 29 MHz, 50 MHz, 144 MHz and 430 MHz amateur bands. Realignment should therefore not be necessary except in the event of a component failure. All component replacement and service should be performed only by an authorized Vertex Standard representative, or the warranty policy may be voided.

The following procedures cover the sometimes critical and tedious adjustments that are not normally required once the transceiver has left the factory. However, if damage occurs and some parts are replaced, realignment may be required. If a sudden problem occurs during normal operation, it is likely due to component failure; realignment should not be done until after the faulty component has been replaced.

We recommend that servicing be performed only by authorized Vertex Standard service technicians who are experienced with the circuitry and fully equipped for repair and alignment. Therefore, if a fault is suspected, contact the dealer from whom the transceiver was purchased for instructions regarding repair. Authorized Vertex Standard service technicians realign all circuits and make complete performance checks to ensure compliance with factory specifications after replacing any faulty components.

Those who do undertake any of the following alignments are cautioned to proceed at their own risk. Problems caused by unauthorized attempts at realignment are not covered by the warranty policy. Also, Vertex Standard must reserve the right to change circuits and alignment procedures in the interest of improved performance, without notifying owners.

Under no circumstances should any alignment be attempted unless the normal function and operation of the transceiver are clearly understood, the cause of the malfunction has been clearly pinpointed and any faulty components replaced, and the need for realignment determined to be absolutely necessary.

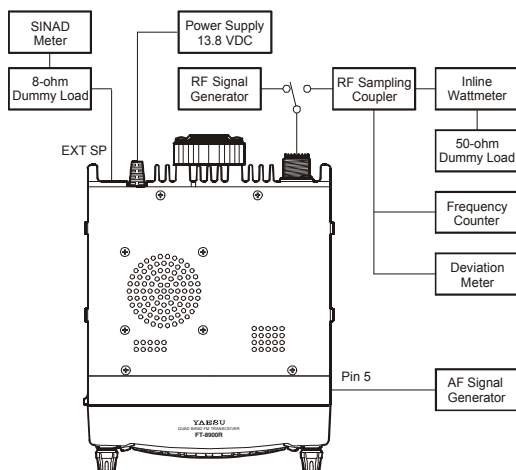

Required Test Equipment

The following test equipment (and thorough familiarity with its correct use) is necessary for complete realignment. Correction of problems caused by misalignment resulting from use of improper test equipment is not covered under the warranty policy. While most steps do not require all of the equipment listed, the interactions of some adjustments may require that more complex adjustments be performed afterwards. Do not attempt to perform only a single step unless it is clearly isolated electrically from all other steps. Have all test equipment ready before beginning, and follow all of the steps in a section in the order presented.

- Regulated DC Power Supply: adjustable from 10 to 17 VDC, 15 A
- RF Signal Generator with calibrated output level at 500 MHz
- Frequency Counter: ± 0.1 ppm accuracy at 500 MHz
- AF Signal Generator
- SINAD Meter
- Oscilloscope
- Spectrum Analyzer
- Deviation Meter (linear detector)
- AF Milivoltmeter
- AF Dummy Load: 8-Ohm, 5 W
- DC Voltmeter: high impedance
- Inline Wattmeter with 5% accuracy at 500 MHz
- 50-Ohm non-reactive Dummy Load: 100 watts at 500 MHz
- VHF/UHF Sampling Coupler

Set up the test equipment as shown for the transceiver alignment, and apply 13.8 VDC power to the transceiver.

Alignment Preparation & Precautions

A dummy load and inline wattmeter must be connected to the main antenna jack in all procedures that call for transmission, except where specified otherwise. Correct alignment is not possible with an antenna. After completing one step, read the following step to determine whether the same test equipment will be required. If not, remove the test equipment (except dummy load and wattmeter, if connected) before proceeding.

Correct alignment requires that the ambient temperature in the repair shop be the same as that of the transceiver and test equipment, and that this temperature be held constant between 68 °C and 86 °F (20 °C ~ 30 °C). When the transceiver is brought into the shop from hot or cold air it should be allowed some time for thermal equalization with the environment before alignment. If possible, alignments should be made with oscillator shields and circuit boards firmly affixed in place. Also, the test equipment must be thoroughly warmed up before beginning.

Notes: Signal levels in dB referred to in alignment are based on 0 dB μ = 0.5 μ V.

Alignment

Entering the Alignment mode

Alignment of the **FT-8900R** is performed using a front-panel software-based procedure. To perform alignment of the transceiver, it must first be placed in the “Alignment Mode,” in which the adjustments will be made and then stored into memory.

To enter the Alignment mode:

1. Press and hold in the “Left” band **[V/M]** key and the Hyper Memory **[6]** key while turning the radio on. Once the radio is on, release these two keys.
2. Press the front panel keys in the following sequence.
“Left” band **[LOW]** → “Left” band **[V/M]** →
“Left” band **[HM]** → “Left” band **[SCN]** →
“Right” band **[LOW]** → “Right” band **[V/M]** →
“Right” band **[HM]** → “Right” band **[SCN]**.
3. You will now note the appearance of “**A-0 REF.xxH**” on the display, this signifies that the transceiver is now in the “Alignment” mode.

PLL Reference Frequency (A-0 REF)

1. Press the “Sub” band **DIAL** knob momentarily, if needed, to switch the “Main” band to be the “Left” band.
2. Tune the “Left” band frequency to 52.050 MHz.
3. Press and hold in the in the “Right” **DIAL** knob, if needed, to set the Alignment parameter to “**A-0 REF.xxH**.”
4. Press the **PTT** switch to activate the transmitter, and adjust the “Right” **DIAL** knob, as needed, so that the counter frequency reading is 52.050 MHz (± 10 Hz).
5. Press the “Right” **DIAL** knob momentarily to switch the “Main” band to be the “Right” band.
6. Tune the “Right” band frequency to 435.050 MHz.
7. Press the **PTT** switch to activate the transmitter, and adjust the “Left” **DIAL** knob, as needed, so that the counter frequency reading is 435.050 MHz (± 100 Hz).

RF Front-end Tuning (A-1 TUN)

1. Connect the DC voltmeter to **R1168** on the MAIN Unit, then inject a 439.050 MHz signal at a level of +10 dB μ (with 1 kHz modulation @ ± 3.5 kHz deviation) from the RF Signal Generator.
2. Press the “Sub” band **DIAL** knob momentarily, if needed, to switch the “Main” band to be the “Right” band.
3. Tune the “Right” band frequency to 439.050 MHz.
4. Press and hold in the in the “Left” **DIAL** knob to set the Alignment parameter to “**A-1 TUN.xxH**.”
5. Adjust the “Left” **DIAL** knob, as needed, so that the DC voltmeter reading is 1.1 V.
6. Tune the “Right” band frequency to 145.050 MHz.
7. Inject a 145.050 MHz signal at a level of +10 dB μ (with 1 kHz modulation @ ± 3.5 kHz deviation) from the RF Signal Generator.
8. Adjust the “Left” **DIAL** knob, as needed, so that the DC voltmeter reading is 1.2 V.
8. Press the “Left” **DIAL** knob momentarily to switch the “Main” band to be the “Left” band.
9. Connect the DC voltmeter to **R1180** on the MAIN Unit.
10. Tune the “Left” band frequency to 439.050 MHz.
11. Inject a 439.050 MHz signal at a level of +10 dB μ (with 1 kHz modulation @ ± 3.5 kHz deviation) from the RF Signal Generator.
12. Adjust the “Right” **DIAL** knob, as needed, so that the DC voltmeter reading is 1.1 V.
13. Tune the “Left” band frequency to 145.050 MHz.
14. Inject a 145.050 MHz signal at a level of +10 dB μ (with 1 kHz modulation @ ± 3.5 kHz deviation) from the RF Signal Generator.
15. Adjust the “Right” **DIAL** knob, as needed, so that the DC voltmeter reading is 1.2 V.

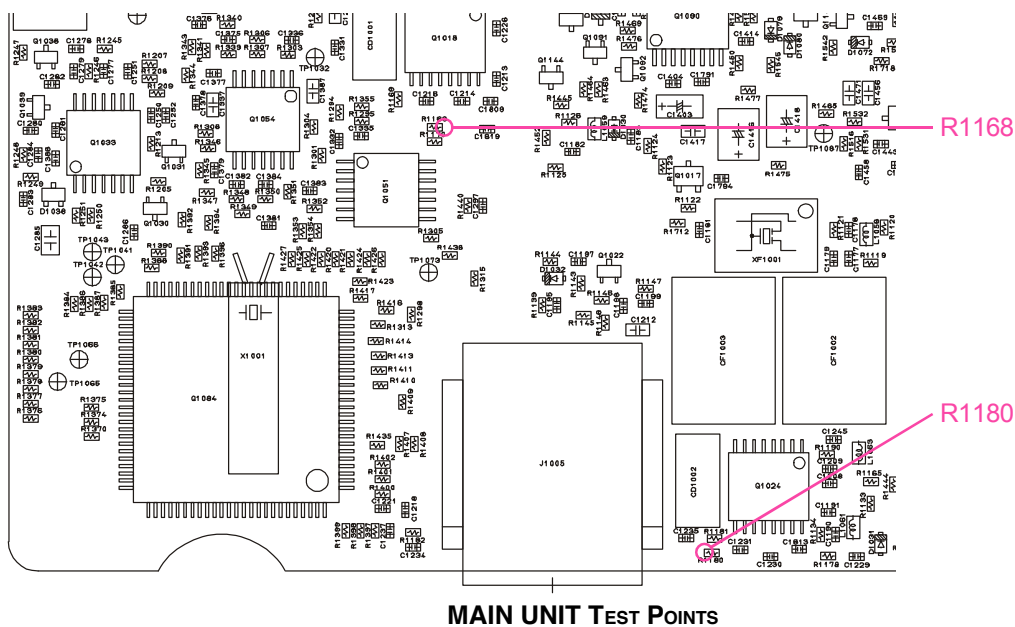

TX Power Output (A-2 PWR)

1. Press the “Sub” band **DIAL** knob momentarily, if needed, to switch the “Main” band to be the “Right” band.
2. Tune the “Right” band frequency to 440.050 MHz, then set the Transmit Power Level to “LOW.”
3. Press and hold in the in the “Left” **DIAL** knob to set the Alignment parameter to “A-2 PWR.xxH.”
4. Press the **PTT** switch to activate the transmitter, and adjust the “Left” **DIAL** knob, as needed, so that the wattmeter reading is 5 Watts (± 0.5 Watt).
5. Increase the Transmit Power Level to “MID2.”
6. Press the **PTT** switch to activate the transmitter, and adjust the “Left” **DIAL** knob, as needed, so that the wattmeter reading is 10 Watts (± 0.5 Watt).
7. Increase the Transmit Power Level to “MID1.”
8. Press the **PTT** switch to activate the transmitter, and adjust the “Left” **DIAL** knob, as needed, so that the wattmeter reading is 20 Watts (± 0.5 Watt).
9. Increase the Transmit Power Level to “HIGH.”
10. Press the **PTT** switch to activate the transmitter, and adjust the “Left” **DIAL** knob, as needed, so that the wattmeter reading is 35 Watts (± 0.5 Watt).
11. Tune the “Right” band frequency to 146.050 MHz, then set the Transmit Power Level to “LOW.”
12. Press the **PTT** switch to activate the transmitter, and adjust the “Left” **DIAL** knob, as needed, so that the wattmeter reading is 5 Watts (± 0.5 Watt).
13. Press the “Left” **DIAL** knob momentarily to switch the “Main” band to be the “Left” band.
14. Tune the “Left” band frequency to 52.050 MHz, then set the Transmit Power Level to “MID2.”
15. Press the **PTT** switch to activate the transmitter, and adjust the “Right” **DIAL** knob, as needed, so that the wattmeter reading is 10 Watts (± 0.5 Watt).
16. Tune the “Left” band frequency to 29.050 MHz, then set the Transmit Power Level to “MID2.”
17. Press the **PTT** switch to activate the transmitter, and adjust the “Right” **DIAL** knob, as needed, so that the wattmeter reading is 20 Watts (± 0.5 Watt).
18. Increase the Transmit Power Level to “HIGH.”
19. Press the **PTT** switch to activate the transmitter, and adjust the “Right” **DIAL** knob, as needed, so that the wattmeter reading is 50 Watts (± 0.5 Watt).

TX Deviation (A-4 DEV)

1. Press the “Sub” band **DIAL** knob momentarily, if needed, to switch the “Main” band to be the “Right” band.
2. Tune the “Right” band frequency to 440.050 MHz, then set the Transmit Power Level to “LOW.”
3. Press and hold in the in the “Left” **DIAL** knob to set the Alignment parameter to “A-4 DEV.xxH.”
4. Inject a 1 kHz audio tone at a level of 80 mV from the Audio Generator.

5. Press the **PTT** switch to activate the transmitter, and adjust the “Left” **DIAL** knob, as needed, so that the deviation meter reading is 4.5 kHz (± 0.2 kHz).
6. Tune the “Right” band frequency to 146.050 MHz, then set the Transmit Power Level to “LOW.”
7. Press the **PTT** switch to activate the transmitter, and adjust the “Left” **DIAL** knob, as needed, so that the deviation meter reading is 4.5 kHz (± 0.2 kHz).
9. Press the “Left” **DIAL** knob momentarily to switch the “Main” band to be the “Left” band.
10. Tune the “Left” band frequency to 52.050 MHz, then set the Transmit Power Level to “LOW.”
11. Press the **PTT** switch to activate the transmitter, and adjust the “Right” **DIAL** knob, as needed, so that the deviation meter reading is 4.5 kHz (± 0.2 kHz).
12. Tune the “Left” band frequency to 29.050 MHz, then set the Transmit Power Level to “LOW.”
13. Press the **PTT** switch to activate the transmitter, and adjust the “Right” **DIAL** knob, as needed, so that the deviation meter reading is 2.3 kHz (± 0.2 kHz).

DCS Tx Deviation (A-5 DCS)

1. Press the “Sub” band **DIAL** knob momentarily, if needed, to switch the “Main” band to be the “Right” band.
2. Press and hold in the in the “Left” **DIAL** knob to set the Alignment parameter to “A-5 DCS.xxH.”
3. Tune the “Right” band frequency to 440.050 MHz, then activate DCS with the 023 DCS code, and set the Transmit Power Level to “LOW.”
4. Press the **PTT** switch to activate the transmitter (with no microphone input), and adjust the “Left” **DIAL** knob, as needed, so that the deviation meter reading is between 0.50 kHz and 0.60 kHz.
5. Tune the “Right” band frequency to 146.050 MHz, then activate DCS with the 023 DCS code, and set the Transmit Power Level to “LOW.”
6. Press the **PTT** switch to activate the transmitter (with no microphone input), adjust the “Left” **DIAL** knob, as needed, so that the deviation meter reading is between 0.50 kHz and 0.60 kHz.
7. Press the “Left” **DIAL** knob momentarily to switch the “Main” band to be the “Left” band.
8. Tune the “Left” band frequency to 52.050 MHz, then activate DCS with the 023 DCS code, and set the Transmit Power Level to “LOW.”
9. Press the **PTT** switch to activate the transmitter (with no microphone input), and adjust the “Right” **DIAL** knob, as needed, so that the deviation meter reading is between 0.65 kHz and 0.75 kHz.
10. Tune the “Left” band frequency to 29.050 MHz, then activate DCS with the 023 DCS code, and set the Transmit Power Level to “LOW.”
11. Press the **PTT** switch to activate the transmitter (with no microphone input), and adjust the “Right” **DIAL**

Alignment

knob, as needed, so that the deviation meter reading is between 0.35 kHz and 0.45 kHz.

CTCSS Tx Deviation (A-6 CTC)

1. Press the “Sub” band **DIAL** knob momentarily, if needed, to switch the “Main” band to be the “Right” band.
2. Press and hold in the in the “Left” DIAL knob to set the Alignment parameter to “A-6 CTC.xxH.”
3. Tune the “Right” band frequency to 440.050 MHz, then activate the CTCSS Encoder with a 100 Hz tone, and set the Transmit Power Level to “LOW.”
4. Press the **PTT** switch to activate the transmitter (with no microphone input), and adjust the “Left” **DIAL** knob, as needed, so that the deviation meter reading is between 0.65 kHz and 0.75 kHz.
5. Tune the “Right” band frequency to 146.050 MHz, then activate the CTCSS Encoder with a 100 Hz tone, and set the Transmit Power Level to “LOW.”
6. Press the **PTT** switch to activate the transmitter (with no microphone input), and adjust the “Left” **DIAL** knob, as needed, so that the deviation meter reading is between 0.65 kHz and 0.75 kHz.
7. Press the “Left” **DIAL** knob momentarily to switch the “Main” band to be the “Left” band.
8. Tune the “Left” band frequency to 52.050 MHz, then activate the CTCSS Encoder with a 100 Hz tone, and set the Transmit Power Level to “LOW.”
9. Press the **PTT** switch to activate the transmitter (with no microphone input), and adjust the “Right” **DIAL** knob, as needed, so that the deviation meter reading is between 0.65 kHz and 0.75 kHz.
10. Tune the “Left” band frequency to 29.050 MHz, then activate the CTCSS Encoder with a 100 Hz tone, and set the Transmit Power Level to “LOW.”
11. Press the **PTT** switch to activate the transmitter (with no microphone input), and adjust the “Right” **DIAL** knob, as needed, so that the deviation meter reading is between 0.35 kHz and 0.45 kHz.

S-Meter Sensitivity (A-7 SM L/V)

1. Inject a 440.050 MHz signal at a level of -5 dB μ from the RF Signal Generator.
2. Press the “Sub” band **DIAL** knob momentarily, if needed, to switch the “Main” band to be the “Right” band.
3. Tune the “Right” band frequency to 440.050 MHz.
4. Press and hold in the in the “Left” **DIAL** knob to set the Alignment parameter to “A-7 SM LV.”
5. Press the “Left” band [**LOW**] key, then adjust the “Left” **DIAL** knob, as needed, so that the S-meter deflects 1 dot.
6. Increase the RF Signal Generator output level to +23 dB μ .
7. Press the “Left” band [**V/M**] key, then adjust the “Left” **DIAL** knob, as needed, so that the S-meter deflects full

scale.

8. Tune the “Right” band frequency to 146.050 MHz.
9. Inject a 146.050 MHz signal at a level of -5 dB μ from the RF Signal Generator.
10. Press the “Left” band [**LOW**] key, then adjust the “Left” **DIAL** knob, as needed, so that the S-meter deflects 1 dot.
11. Increase the RF Signal Generator output level to +23 dB μ .
12. Press the “Left” band [**V/M**] key, then adjust the “Left” **DIAL** knob, as needed, so that the S-meter deflects full scale.
13. Press the “Sub” band **DIAL** knob momentarily, if needed, to switch the “Main” band to be the “Left” band.
14. Tune the “Left” band frequency to 440.050 MHz.
15. Inject a 440.050 MHz signal at a level of -5 dB μ from the RF Signal Generator.
16. Press the “Left” band [**LOW**] key, then adjust the “Right” **DIAL** knob, as needed, so that the S-meter deflects 1 dot.
17. Increase the RF Signal Generator output level to +23 dB μ .
18. Press the “Left” band [**V/M**] key, then adjust the “Right” **DIAL** knob, as needed, so that the S-meter deflects full scale.
19. Tune the “Left” band frequency to 146.050 MHz.
20. Inject a 146.050 MHz signal at a level of -5 dB μ from the RF Signal Generator.
21. Press the “Left” band [**LOW**] key, then adjust the “Right” **DIAL** knob, as needed, so that the S-meter deflects 1 dot.
22. Increase the RF Signal Generator output level to +23 dB μ .
23. Press the “Left” band [**V/M**] key, then adjust the “Right” **DIAL** knob, as needed, so that the S-meter deflects full scale.
24. Tune the “Left” band frequency to 52.050 MHz.
25. Inject a 52.050 MHz signal at a level of -5 dB μ from the RF Signal Generator.
26. Press the “Left” band [**LOW**] key, then adjust the “Right” **DIAL** knob, as needed, so that the S-meter deflects 1 dot.
27. Increase the RF Signal Generator output level to +23 dB μ .
28. Press the “Left” band [**V/M**] key then adjust the “Right” **DIAL** knob, as needed, so that the S-meter deflects full scale.
29. Tune the “Left” band frequency to 29.050 MHz.
30. Inject a 146.050 MHz signal at a level of -5 dB μ from the RF Signal Generator.
31. Press the “Left” band [**LOW**] key, then adjust the “Right” **DIAL** knob, as needed, so that the S-meter deflects 1 dot.
32. Increase the RF Signal Generator output level to +23 dB μ .

33. Press the “Left” band [V/M] key, then adjust the “Right” **DIAL** knob, as needed, so that the S-meter deflects full scale.
34. Tune the “Left” band frequency to 868.95 MHz.
35. Inject an 868.95 MHz signal at a level of $-3 \text{ dB}\mu$ from the RF Signal Generator.
36. Press the “Left” band [LOW] key, then adjust the “Right” **DIAL** knob, as needed, so that the S-meter deflects 1 dot.
37. Increase the RF Signal Generator output level to $+31 \text{ dB}\mu$.
38. Press the “Left” band [V/M] key, then adjust the “Right” **DIAL** knob, as needed, so that the S-meter deflects full scale.
39. Tune the “Left” band frequency to 350.050 MHz.
40. Inject a 350.050 MHz signal at a level of $-5 \text{ dB}\mu$ from the RF Signal Generator.
41. Press the “Left” band [LOW] key, then adjust the “Right” **DIAL** knob, as needed, so that the S-meter deflects 1 dot.
42. Increase the RF Signal Generator output level to $+23 \text{ dB}\mu$.
43. Press the “Left” band [V/M] key, then adjust the “Right” **DIAL** knob, as needed, so that the S-meter deflects full scale.

DC Voltmeter (A-8 BAT SC)

1. Set the power supply voltage to 13.8 VDC.
2. Press and hold in the in the “Sub” band **DIAL** knob to set the Alignment parameter to “A-8 BAT SC.”
3. Press the “Left” band [SCN] key.

To close the Alignment mode, just press and hold in the “Right” **VOL** knob for 2 seconds (to turn the power off). The next time the transceiver is turned on, normal operation may resume.

Important Note!

The “A-3 PRO” (TX Protector) parameter is only used at the factory.

Do not adjust this parameter's values.

**Downloaded by
RadioAmateur.EU**

Note

Downloaded by
RadioAmateur.EU

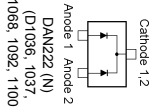
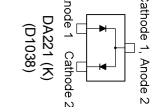
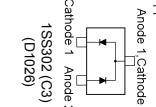
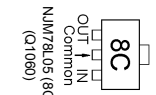
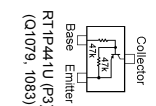
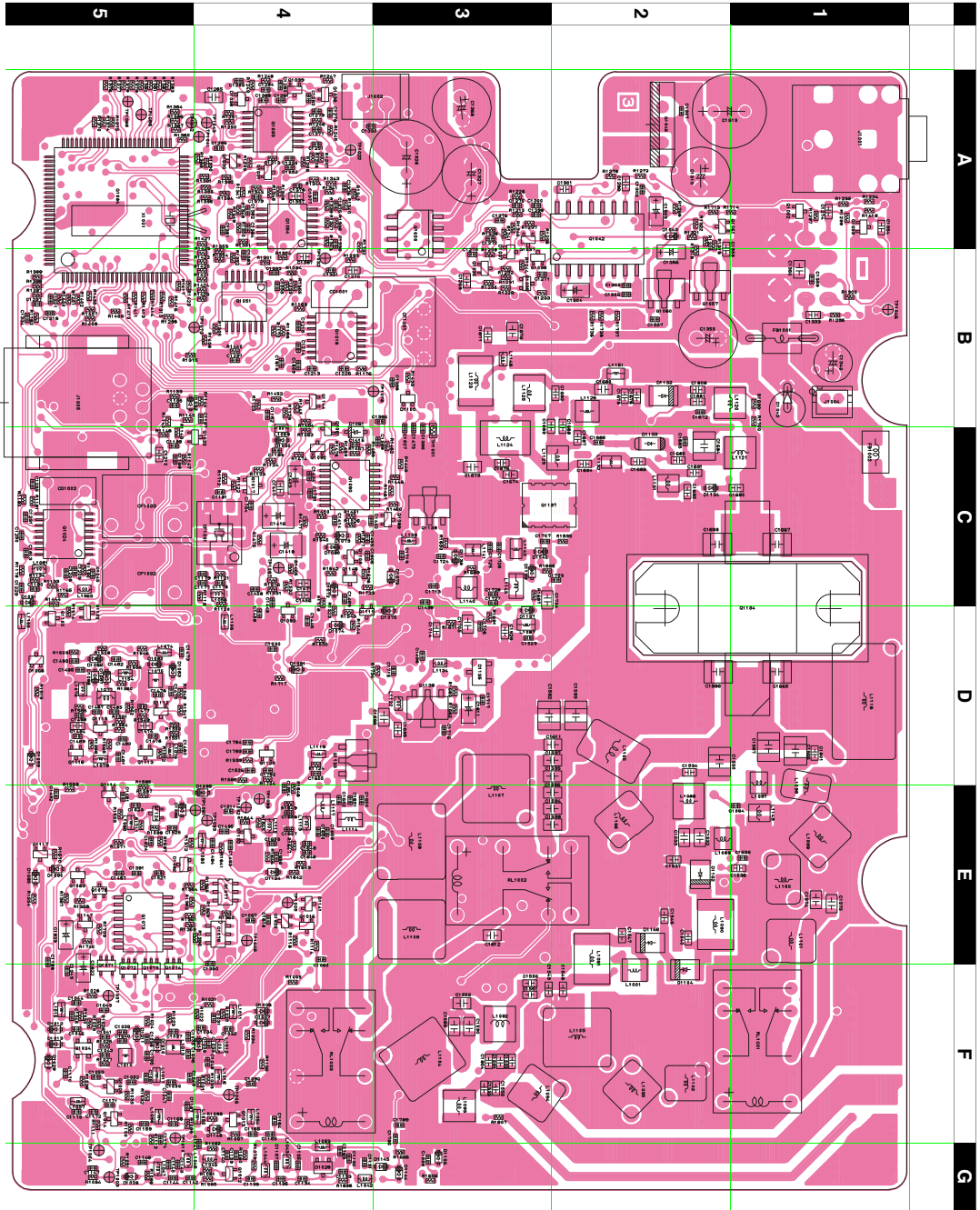
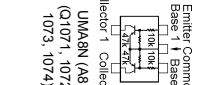
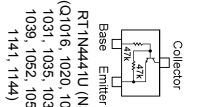
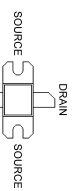
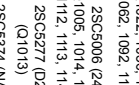
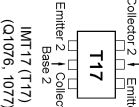
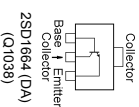
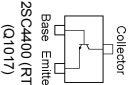
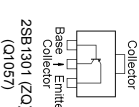
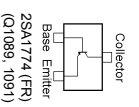
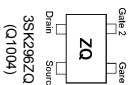
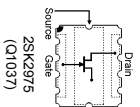
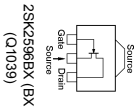
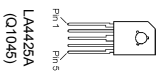
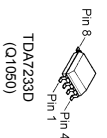
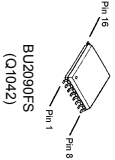
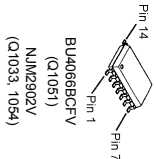
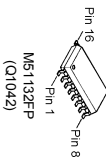
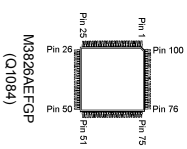

Side A

MAIN Unit

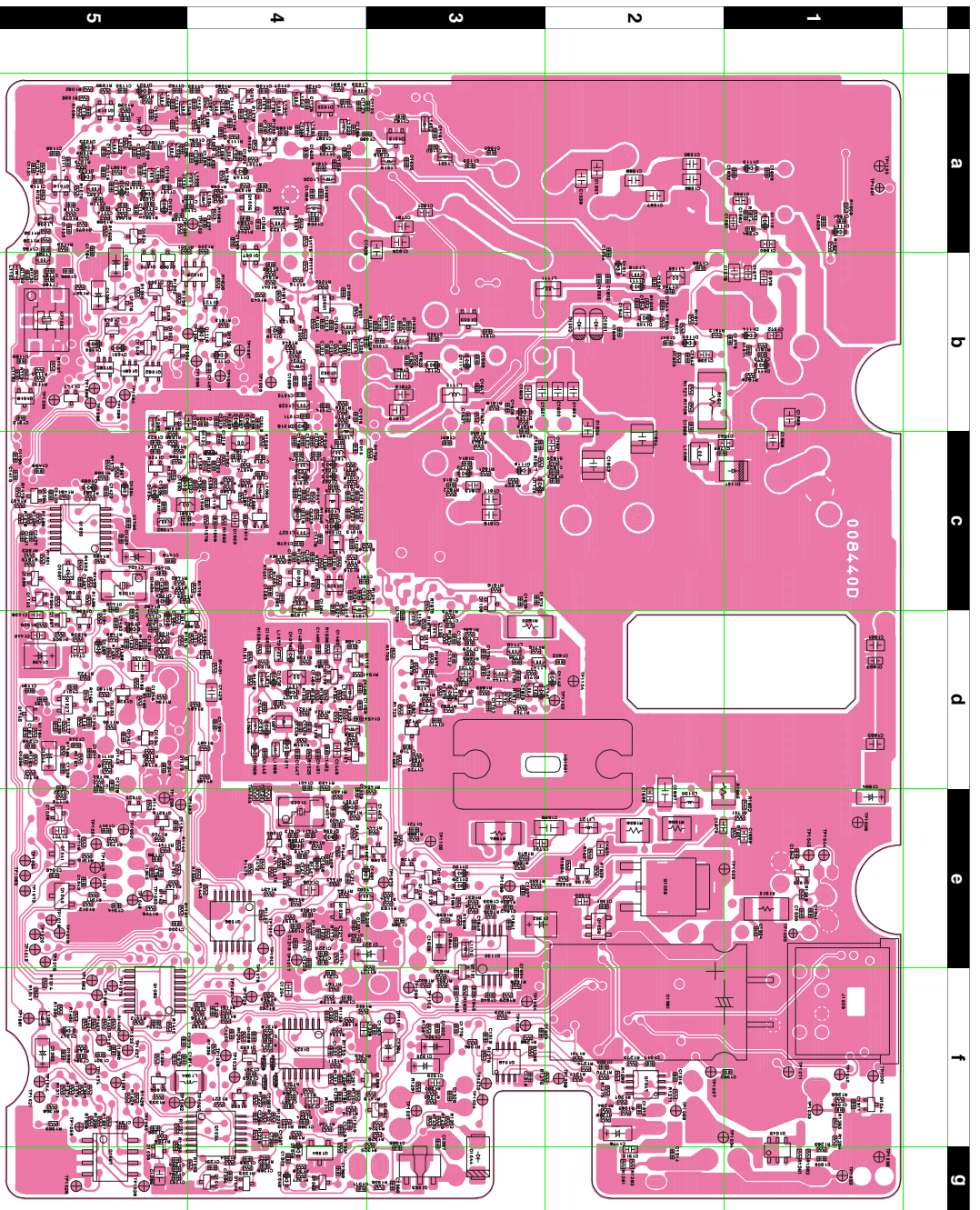

Side B

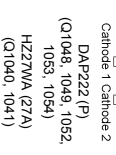
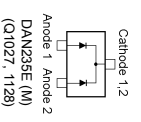
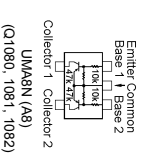
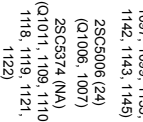
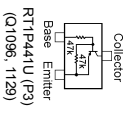
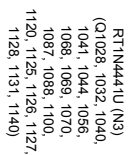
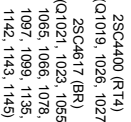
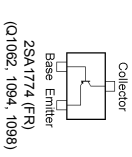
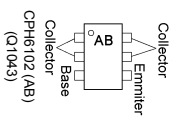
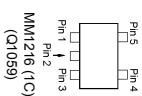
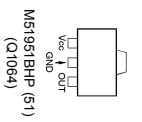
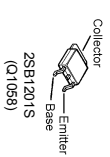
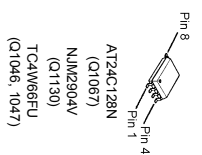
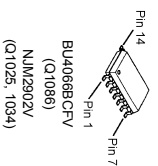
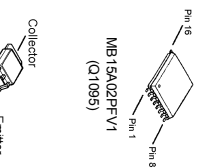

MAIN Unit

Parts List

REF	DESCRIPTION	VALUE	V/W	TOL.	MFR'S DESIG	VXSTD P/N	VERS.	LOT	SIDE	LAY ADR
PCB with Component						CS1769004	TYP: A2U	DST: USA		
						CS1769005	TYP: A1	DST: EXP		
						CS1769006	TYP: A2	DST: EXP		
						CS1769007	TYP: A3	DST: EXP		
						CS1769008	TYP: B1	DST: EXP		
						CS1769009	TYP: B2	DST: EXP		
						CS1769010	TYP: B3	DST: EXP		
						CS1769011	TYP: C1	DST: EXP		
						CS1769012	TYP: C2	DST: EXP		
						CS1769013	TYP: C3	DST: EXP		
						CS1769014	TYP: D1	DST: EXP		
						CS1769015	TYP: D2	DST: EXP		
						CS1769016	TYP: B1G	DST: FRG		
						CS1769017	TYP: B2G	DST: FRG		
Printed Circuit Board					AH008M000	FR008440D		1-		
C 1001	CHIP CAP.	0.001uF	50V	B	GRM36B102K50PT	K22178809		1-	B	b3
C 1002	CHIP CAP.	0.001uF	50V	B	GRM36B102K50PT	K22178809		1-	B	b3
C 1004	CHIP CAP.	3pF	50V	CJ	GRM36CJ030B50PT	K22178290		1-	B	b3
C 1005	CHIP CAP.	33pF	50V	CH	GRM36CH330J50PT	K22178224		1-	B	b3
C 1006	CHIP CAP.	0.001uF	50V	B	GRM36B102K50PT	K22178809		1-	B	b3
C 1009	CHIP CAP.	0.001uF	50V	B	GRM36B102K50PT	K22178809		1-	B	b4
C 1010	CHIP CAP.	0.001uF	50V	B	GRM36B102K50PT	K22178809		1-	B	b4
C 1012	CHIP CAP.	0.001uF	50V	B	GRM36B102K50PT	K22178809		1-	B	b4
C 1013	CHIP CAP.	0.001uF	50V	B	GRM36B102K50PT	K22178809		1-	B	b4
C 1014	CHIP CAP.	0.001uF	50V	B	GRM36B102K50PT	K22178809		1-	B	b4
C 1015	CHIP CAP.	8pF	50V	CH	GRM36CH080B50PT	K22178295		1-	B	c4
C 1016	CHIP CAP.	0.001uF	50V	B	GRM36B102K50PT	K22178809		1-	B	b4
C 1017	CHIP CAP.	2pF	50V	CK	GRM36CK020B50PT	K22178289		1-	B	c4
C 1018	CHIP CAP.	33pF	50V	CH	GRM36CH330J50PT	K22178224		1-	B	c4
C 1019	CHIP CAP.	0.5pF	50V	CK	GRM36CK0R5B50PT	K22178285		1-	B	c4
C 1020	CHIP CAP.	2pF	50V	CK	GRM36CK020B50PT	K22178289		1-	B	c4
C 1021	CHIP CAP.	33pF	50V	CH	GRM36CH330J50PT	K22178224		1-	B	c4
C 1022	CHIP CAP.	0.5pF	50V	CK	GRM36CK0R5B50PT	K22178285		1-	B	c4
C 1023	CHIP CAP.	33pF	50V	CH	GRM36CH330J50PT	K22178224		1-	B	c4
C 1025	CHIP CAP.	10pF	50V	CH	GRM36CH100D50PT	K22178212		1-	B	c4
C 1026	CHIP CAP.	0.01uF	16V	B	GRM36B103K16PT	K22128804		1-	B	c4
C 1027	CHIP CAP.	0.001uF	50V	B	GRM36B102K50PT	K22178809		1-	B	c4
C 1028	CHIP CAP.	2pF	50V	CK	GRM36CK020B50PT	K22178289		1-	B	c4
C 1029	CHIP CAP.	0.001uF	50V	B	GRM36B102K50PT	K22178809		1-	B	c4
C 1030	CHIP CAP.	10pF	50V	CH	GRM36CH100D50PT	K22178212		1-	A	D4
C 1031	CHIP CAP.	0.001uF	50V	B	GRM36B102K50PT	K22178809		1-	A	F4
C 1032	CHIP CAP.	56pF	50V	CH	GRM36CH560J50PT	K22178230		1-	A	F4
C 1033	CHIP CAP.	0.5pF	50V	CK	GRM36CK0R5B50PT	K22178285		1-	A	F4
C 1034	CHIP CAP.	33pF	50V	CH	GRM36CH330J50PT	K22178224		1-	A	F4
C 1035	CHIP CAP.	0.5pF	50V	CK	GRM36CK0R5B50PT	K22178285		1-	A	F5
C 1036	CHIP CAP.	1.5pF	50V	CK	GRM36CK1R5B50PT	K22178288		1-	A	F5
C 1037	CHIP CAP.	33pF	50V	CH	GRM36CH330J50PT	K22178224		1-	A	F5
C 1038	CHIP CAP.	0.5pF	50V	CK	GRM36CK0R5B50PT	K22178285		1-	A	F5
C 1039	CHIP CAP.	27pF	50V	CH	GRM36CH270J50PT	K22178222		1-	A	F5
C 1041	CHIP CAP.	10pF	50V	CH	GRM36CH100D50PT	K22178212		1-	A	F5
C 1042	CHIP CAP.	0.01uF	16V	B	GRM36B103K16PT	K22128804		1-	A	F5
C 1043	CHIP CAP.	0.001uF	50V	B	GRM36B102K50PT	K22178809		1-	A	F5
C 1044	CHIP CAP.	0.001uF	50V	B	GRM36B102K50PT	K22178809		1-	A	F5
C 1045	CHIP CAP.	2pF	50V	CK	GRM36CK020B50PT	K22178289		1-	A	F5
C 1046	CHIP CAP.	0.001uF	50V	B	GRM36B102K50PT	K22178809		1-	A	F5
C 1047	CHIP CAP.	0.001uF	50V	B	GRM36B102K50PT	K22178809		1-	A	F5
C 1048	CHIP CAP.	0.001uF	50V	B	GRM36B102K50PT	K22178809		1-	A	F4
C 1049	CHIP CAP.	6pF	50V	CH	GRM36CH060B50PT	K22178293		1-	A	F5
C 1050	CHIP CAP.	1.5pF	50V	CK	GRM36CK1R5B50PT	K22178288		1-	A	F5
C 1051	CHIP CAP.	8pF	50V	CH	GRM36CH080B50PT	K22178295		1-	A	F5
C 1052	CHIP CAP.	22pF	50V	CH	GRM36CH220J50PT	K22178220		1-	A	F5
C 1053	CHIP CAP.	1pF	50V	CK	GRM36CK010B50PT	K22178287		1-	A	F5
C 1054	CHIP CAP.	27pF	50V	CH	GRM36CH270J50PT	K22178222		1-	B	a2
C 1055	CHIP CAP.	0.001uF	50V	B	GRM36B102K50PT	K22178809		1-	B	a3
C 1056	CHIP CAP.	10pF	50V	CH	GRM36CH100D50PT	K22178212		1-	B	a4
C 1057	CHIP CAP.	22pF	50V	CH	GRM36CH220J50PT	K22178220		1-	B	a4
C 1059	CHIP CAP.	0.001uF	50V	B	GRM36B102K50PT	K22178809		1-	B	a4
C 1060	CHIP CAP.	0.001uF	50V	B	GRM36B102K50PT	K22178809		1-	A	E4
C 1061	CHIP CAP.	2pF	50V	CK	GRM36CK020B50PT	K22178289		1-	B	a4
C 1062	CHIP CAP.	0.001uF	50V	B	GRM36B102K50PT	K22178809		1-	B	a4
C 1063	CHIP CAP.	0.001uF	50V	B	GRM36B102K50PT	K22178809		1-	B	a4
C 1065	CHIP CAP.	0.001uF	50V	B	GRM36B102K50PT	K22178809		1-	B	a4
C 1066	CHIP CAP.	0.001uF	50V	B	GRM36B102K50PT	K22178809		1-	B	b4
C 1067	CHIP CAP.	0.001uF	50V	B	GRM36B102K50PT	K22178809		1-	A	E4
C 1068	CHIP CAP.	0.001uF	50V	B	GRM36B102K50PT	K22178809		1-	B	b4
C 1069	CHIP CAP.	8pF	50V	CH	GRM36CH080B50PT	K22178295		1-	B	b4

MAIN Unit

Parts List

REF	DESCRIPTION	VALUE	V/W	TOL.	MFR'S DESIG	VXSTD P/N	VERS.	LOT	SIDE	LAY ADR
C 1070	CHIP CAP.	2pF	50V	CK	GRM36CK020B50PT	K22178289		1-	B	b4
C 1071	CHIP CAP.	39pF	50V	CH	GRM36CH390J50PT	K22178226		1-	B	b4
C 1072	CHIP CAP.	0.75pF	50V	CK	GRM36CKR75B50PT	K22178286		1-	B	c4
C 1073	CHIP CAP.	18pF	50V	CH	GRM36CH180J50PT	K22178218		1-	B	c4
C 1074	CHIP CAP.	3pF	50V	CJ	GRM36CJ030B50PT	K22178290		1-	B	c4
C 1075	CHIP CAP.	39pF	50V	CH	GRM36CH390J50PT	K22178226		1-	B	c4
C 1076	CHIP CAP.	0.5pF	50V	CK	GRM36CK0R5B50PT	K22178285		1-	B	c4
C 1077	CHIP CAP.	8pF	50V	CH	GRM36CH080B50PT	K22178295		1-	B	c4
C 1078	CHIP CAP.	3pF	50V	CJ	GRM36CJ030B50PT	K22178290		1-	B	c4
C 1079	CHIP CAP.	39pF	50V	CH	GRM36CH390J50PT	K22178226		1-	B	c4
C 1080	CHIP CAP.	10pF	50V	CH	GRM36CH100D50PT	K22178212		1-	B	c4
C 1081	CHIP CAP.	0.01uF	16V	B	GRM36B103K16PT	K22128804		1-	B	c4
C 1082	CHIP CAP.	0.001uF	50V	B	GRM36B102K50PT	K22178809		1-	B	c4
C 1083	CHIP CAP.	7pF	50V	CH	GRM36CH070B50PT	K22178294		1-	B	c4
C 1084	CHIP CAP.	0.001uF	50V	B	GRM36B102K50PT	K22178809		1-	B	c4
C 1090	CHIP CAP.	0.01uF	16V	B	GRM36B103K16PT	K22128804		1-	A	F4
C 1097	CHIP CAP.	0.001uF	50V	B	GRM36B102K50PT	K22178809		1-	B	a4
C 1102	CHIP CAP.	0.001uF	50V	B	GRM36B102K50PT	K22178809		1-	B	a4
C 1103	CHIP CAP.	8pF	50V	CH	GRM36CH080B50PT	K22178295		1-	B	a4
C 1104	CHIP CAP.	2pF	50V	CK	GRM36CK020B50PT	K22178289		1-	B	a5
C 1105	CHIP CAP.	0.001uF	50V	B	GRM36B102K50PT	K22178809		1-	B	a4
C 1106	CHIP CAP.	39pF	50V	CH	GRM36CH390J50PT	K22178226		1-	B	a5
C 1107	CHIP CAP.	0.75pF	50V	CK	GRM36CKR75B50PT	K22178286		1-	B	a5
C 1108	CHIP CAP.	3pF	50V	CJ	GRM36CJ030B50PT	K22178290		1-	B	a5
C 1109	CHIP CAP.	18pF	50V	CH	GRM36CH180J50PT	K22178218		1-	B	a5
C 1110	CHIP CAP.	39pF	50V	CH	GRM36CH390J50PT	K22178226		1-	B	a5
C 1111	CHIP CAP.	0.5pF	50V	CK	GRM36CK0R5B50PT	K22178285		1-	B	a5
C 1112	CHIP CAP.	2pF	50V	CK	GRM36CK020B50PT	K22178289		1-	B	a5
C 1113	CHIP CAP.	8pF	50V	CH	GRM36CH080B50PT	K22178295		1-	B	a5
C 1114	CHIP CAP.	39pF	50V	CH	GRM36CH390J50PT	K22178226		1-	B	a5
C 1115	CHIP CAP.	0.001uF	50V	B	GRM36B102K50PT	K22178809		1-	B	a5
C 1116	CHIP CAP.	0.001uF	50V	B	GRM36B102K50PT	K22178809		1-	B	a5
C 1117	CHIP CAP.	33pF	50V	CH	GRM36CH330J50PT	K22178224		1-	B	a5
C 1118	CHIP CAP.	0.001uF	50V	B	GRM36B102K50PT	K22178809		1-	B	a5
C 1119	CHIP CAP.	0.01uF	16V	B	GRM36B103K16PT	K22128804		1-	B	a5
C 1120	CHIP CAP.	0.001uF	50V	B	GRM36B102K50PT	K22178809		1-	B	a5
C 1121	CHIP CAP.	7pF	50V	CH	GRM36CH070B50PT	K22178294		1-	B	a5
C 1122	CHIP CAP.	68pF	50V	CH	GRM36CH680J50PT	K22178232		1-	B	a3
C 1123	CHIP CAP.	100pF	50V	CH	GRM36CH101J50PT	K22178236		1-	B	a4
C 1124	CHIP CAP.	0.001uF	50V	B	GRM36B102K50PT	K22178809		1-	B	a4
C 1125	CHIP CAP.	27pF	50V	CH	GRM36CH270J50PT	K22178222		1-	B	a4
C 1126	CHIP CAP.	12pF	50V	CH	GRM36CH120J50PT	K22178214		1-	B	a4
C 1127	CHIP CAP.	9pF	50V	CH	GRM36CH090B50PT	K22178296		1-	B	a4
C 1128	CHIP CAP.	22pF	50V	CH	GRM36CH220J50PT	K22178220		1-	B	a4
C 1129	CHIP CAP.	39pF	50V	CH	GRM36CH390J50PT	K22178226		1-	B	a4
C 1130	CHIP CAP.	0.01uF	16V	B	GRM36B103K16PT	K22128804		1-	B	a4
C 1131	CHIP CAP.	120pF	50V	CH	GRM36CH121J50PT	K22178238		1-	A	G4
C 1132	CHIP CAP.	220pF	25V	CH	GRM36CH221J25PT	K22148203		1-	A	G4
C 1133	CHIP CAP.	0.001uF	50V	B	GRM36B102K50PT	K22178809		1-	A	G4
C 1134	CHIP CAP.	100pF	50V	CH	GRM36CH101J50PT	K22178236		1-	A	G4
C 1136	CHIP CAP.	33pF	50V	CH	GRM36CH330J50PT	K22178224		1-	A	G4
C 1137	CHIP CAP.	47pF	50V	CH	GRM36CH470J50PT	K22178228		1-	A	G4
C 1138	CHIP CAP.	150pF	50V	CH	GRM36CH151J50PT	K22178240		1-	A	G4
C 1139	CHIP CAP.	0.01uF	16V	B	GRM36B103K16PT	K22128804		1-	A	G4
C 1140	CHIP CAP.	0.01uF	16V	B	GRM36B103K16PT	K22128804		1-	A	G4
C 1141	CHIP CAP.	68pF	50V	CH	GRM36CH680J50PT	K22178232		1-	A	F4
C 1142	CHIP CAP.	10pF	50V	CH	GRM36CH100D50PT	K22178212		1-	A	G5
C 1143	CHIP CAP.	62pF	50V	CH	GRM36CH620J50PT	K22178231		1-	A	G5
C 1144	CHIP CAP.	10pF	50V	CH	GRM36CH100D50PT	K22178212		1-	A	G5
C 1145	CHIP CAP.	62pF	50V	CH	GRM36CH620J50PT	K22178231		1-	A	G5
C 1146	CHIP CAP.	0.01uF	16V	B	GRM36B103K16PT	K22128804		1-	A	G5
C 1147	CHIP CAP.	0.001uF	50V	B	GRM36B102K50PT	K22178809		1-	A	G5
C 1148	CHIP CAP.	0.01uF	16V	B	GRM36B103K16PT	K22128804		1-	B	a4
C 1149	CHIP CAP.	33pF	50V	CH	GRM36CH330J50PT	K22178224		1-	B	a4
C 1150	CHIP CAP.	4pF	50V	CH	GRM36CH040B50PT	K22178291		1-	B	a4
C 1151	CHIP CAP.	33pF	50V	CH	GRM36CH330J50PT	K22178224		1-	B	a4
C 1152	CHIP CAP.	4pF	50V	CH	GRM36CH040B50PT	K22178291		1-	B	a5
C 1153	CHIP CAP.	33pF	50V	CH	GRM36CH330J50PT	K22178224		1-	B	a5
C 1154	CHIP CAP.	0.01uF	16V	B	GRM36B103K16PT	K22128804		1-	B	a5
C 1155	CHIP CAP.	0.001uF	50V	B	GRM36B102K50PT	K22178809		1-	B	a5
C 1156	CHIP CAP.	0.001uF	50V	B	GRM36B102K50PT	K22178809		1-	B	a5
C 1157	CHIP CAP.	0.01uF	16V	B	GRM36B103K16PT	K22128804		1-	B	a5
C 1159	CHIP CAP.	2pF	50V	CK	GRM36CK020B50PT	K22178289		1-	B	a3
C 1160	CHIP CAP.	47pF	50V	CH	GRM36CH470J50PT	K22178228		1-	B	a3
C 1161	CHIP CAP.	1pF	50V	CK	GRM36CK010B50PT	K22178287		1-	B	a3
C 1162	CHIP CAP.	2pF	50V	CK	GRM36CK020B50PT	K22178289		1-	B	a3

MAIN Unit

Parts List

REF	DESCRIPTION	VALUE	V/W	TOL.	MFR'S DESIG	VXSTD P/N	VERS.	LOT	SIDE	LAY ADR
C 1163	CHIP CAP.	7pF	50V	CH	GRM36CH070B50PT	K22178294		1-	A	G4
C 1164	CHIP CAP.	2pF	50V	CK	GRM36CK020B50PT	K22178289		1-	A	F4
C 1165	CHIP CAP.	3pF	50V	CJ	GRM36CJ030B50PT	K22178290		1-	A	F4
C 1166	CHIP CAP.	12pF	50V	CH	GRM36CH120J50PT	K22178214		1-	A	F4
C 1167	CHIP CAP.	0.001uF	50V	B	GRM36B102K50PT	K22178809		1-	A	F5
C 1168	CHIP CAP.	0.75pF	50V	CK	GRM36CKR75B50PT	K22178286		1-	A	F5
C 1169	CHIP CAP.	10pF	50V	CH	GRM36CH100D50PT	K22178212		1-	A	F5
C 1170	CHIP CAP.	10pF	50V	CH	GRM36CH100D50PT	K22178212		1-	A	F5
C 1171	CHIP CAP.	0.5pF	50V	CK	GRM36CK0R5B50PT	K22178285		1-	A	F5
C 1172	CHIP CAP.	5pF	50V	CH	GRM36CH050B50PT	K22178292		1-	A	F5
C 1173	CHIP CAP.	0.001uF	50V	B	GRM36B102K50PT	K22178809		1-	A	F5
C 1174	CHIP CAP.	0.001uF	50V	B	GRM36B102K50PT	K22178809		1-	A	F5
C 1175	CHIP CAP.	0.001uF	50V	B	GRM36B102K50PT	K22178809		1-	B	a5
C 1176	CHIP CAP.	0.001uF	50V	B	GRM36B102K50PT	K22178809		1-	B	c4
C 1177	CHIP CAP.	0.001uF	50V	B	GRM36B102K50PT	K22178809		1-	A	C4
C 1178	CHIP CAP.	12pF	50V	CH	GRM36CH120J50PT	K22178214		1-	A	C4
C 1179	CHIP CAP.	0.022uF	16V	B	GRM36B223K16PT	K22128806		1-	A	C4
C 1180	CHIP CAP.	6pF	50V	CH	GRM36CH060B50PT	K22178293		1-	B	d4
C 1182	CHIP CAP.	0.01uF	16V	B	GRM36B103K16PT	K22128804		1-	A	B4
C 1183	CHIP CAP.	15pF	50V	CH	GRM36CH150J50PT	K22178216		1-	A	C4
C 1184	CHIP CAP.	0.001uF	50V	B	GRM36B102K50PT	K22178809		1-	B	a5
C 1185	CHIP CAP.	0.001uF	50V	B	GRM36B102K50PT	K22178809		1-	B	b5
C 1186	CHIP CAP.	12pF	50V	CH	GRM36CH120J50PT	K22178214		1-	B	a5
C 1187	CHIP CAP.	0.022uF	16V	B	GRM36B223K16PT	K22128806		1-	B	b5
C 1188	CHIP CAP.	6pF	50V	CH	GRM36CH060B50PT	K22178293		1-	A	E5
C 1191	CHIP CAP.	0.01uF	50V	B	GRM39B103M50PT	K22174823		1-	B	d5
C 1192	CHIP CAP.	0.01uF	16V	B	GRM36B103K16PT	K22128804		1-	B	b5
C 1193	CHIP CAP.	0.001uF	50V	B	GRM36B102K50PT	K22178809		1-	B	c5
C 1194	CHIP CAP.	0.1uF	10V	B	GRM36B104K10PT	K22108802		1-	B	e5
C 1195	CHIP CAP.	0.001uF	50V	B	GRM36B102K50PT	K22178809		1-	A	B5
C 1196	CHIP CAP.	0.01uF	16V	B	GRM36B103K16PT	K22128804		1-	B	e5
C 1197	CHIP CAP.	0.01uF	16V	B	GRM36B103K16PT	K22128804		1-	A	B4
C 1198	CHIP CAP.	0.001uF	50V	B	GRM36B102K50PT	K22178809		1-	A	C5
C 1199	CHIP CAP.	0.01uF	16V	B	GRM36B103K16PT	K22128804		1-	A	C5
C 1200	CHIP CAP.	0.1uF	10V	B	GRM36B104K10PT	K22108802		1-	B	e5
C 1201	CHIP CAP.	0.001uF	50V	B	GRM36B102K50PT	K22178809		1-	B	f4
C 1202	CHIP CAP.	0.001uF	50V	B	GRM36B102K50PT	K22178809		1-	B	f4
C 1203	CHIP CAP.	0.001uF	50V	B	GRM36B102K50PT	K22178809		1-	B	f4
C 1204	CHIP CAP.	1uF	10V	F	GRM39F105Z10PT	K22105001		1-	B	f4
C 1205	CHIP CAP.	0.001uF	50V	B	GRM36B102K50PT	K22178809		1-	B	f4
C 1206	CHIP CAP.	0.01uF	16V	B	GRM36B103K16PT	K22128804		1-	B	e4
C 1207	CHIP CAP.	22pF	50V	CH	GRM36CH220J50PT	K22178220		1-	B	e4
C 1208	CHIP CAP.	0.01uF	16V	B	GRM36B103K16PT	K22128804		1-	A	C5
C 1209	CHIP CAP.	27pF	50V	CH	GRM36CH270J50PT	K22178222		1-	A	C5
C 1210	CHIP CAP.	22pF	50V	CH	GRM36CH220J50PT	K22178220		1-	B	e4
C 1211	CHIP CAP.	2pF	50V	CK	GRM36CK020B50PT	K22178289		1-	B	d5
C 1212	CHIP CAP.	1uF	10V	F	GRM39F105Z10PT	K22105001		1-	A	C5
C 1213	CHIP CAP.	0.001uF	50V	B	GRM36B102K50PT	K22178809		1-	A	B4
C 1214	CHIP CAP.	0.1uF	10V	B	GRM36B104K10PT	K22108802		1-	A	B4
C 1215	CHIP CAP.	56pF	50V	CH	GRM36CH560J50PT	K22178230		1-	B	e4
C 1216	CHIP CAP.	56pF	50V	CH	GRM36CH560J50PT	K22178230		1-	A	B4
C 1217	CHIP CAP.	0.01uF	16V	B	GRM36B103K16PT	K22128804		1-	B	e4
C 1218	CHIP CAP.	0.01uF	16V	B	GRM36B103K16PT	K22128804		1-	A	B5
C 1219	CHIP CAP.	0.001uF	50V	B	GRM36B102K50PT	K22178809		1-	B	e4
C 1220	CHIP CAP.	0.001uF	50V	B	GRM36B102K50PT	K22178809		1-	B	e4
C 1221	CHIP CAP.	0.047uF	10V	B	GRM36B473K10PT	K22108801		1-	A	B5
C 1222	CHIP CAP.	220pF	25V	CH	GRM36CH221J25PT	K22148203		1-	B	e4
C 1223	CHIP CAP.	470pF	50V	B	GRM36B471K50PT	K22178805		1-	B	e4
C 1224	CHIP CAP.	470pF	50V	B	GRM36B471K50PT	K22178805		1-	B	e4
C 1225	CHIP CAP.	0.1uF	10V	B	GRM36B104K10PT	K22108802		1-	B	e4
C 1226	CHIP CAP.	100pF	50V	CH	GRM36CH101J50PT	K22178236		1-	A	B4
C 1227	CHIP TA.CAP.	22uF	6.3V		TEMSVA0J226M-8R	K78080047		1-	B	e3
C 1228	CHIP CAP.	0.001uF	50V	B	GRM36B102K50PT	K22178809		1-	B	d5
C 1229	CHIP CAP.	0.001uF	50V	B	GRM36B102K50PT	K22178809		1-	A	C5
C 1230	CHIP CAP.	0.1uF	10V	B	GRM36B104K10PT	K22108802		1-	A	C5
C 1231	CHIP CAP.	56pF	50V	CH	GRM36CH560J50PT	K22178230		1-	A	C5
C 1232	CHIP CAP.	56pF	50V	CH	GRM36CH560J50PT	K22178230		1-	B	d5
C 1233	CHIP CAP.	0.01uF	16V	B	GRM36B103K16PT	K22128804		1-	B	d5
C 1234	CHIP CAP.	0.01uF	16V	B	GRM36B103K16PT	K22128804		1-	A	B5
C 1235	CHIP CAP.	0.001uF	50V	B	GRM36B102K50PT	K22178809		1-	A	C5
C 1236	CHIP CAP.	0.001uF	50V	B	GRM36B102K50PT	K22178809		1-	B	d5
C 1237	CHIP CAP.	0.047uF	10V	B	GRM36B473K10PT	K22108801		1-	A	B5
C 1238	CHIP CAP.	220pF	25V	CH	GRM36CH221J25PT	K22148203		1-	B	d5
C 1239	CHIP CAP.	470pF	50V	B	GRM36B471K50PT	K22178805		1-	B	d5
C 1240	CHIP CAP.	470pF	50V	B	GRM36B471K50PT	K22178805		1-	B	d5
C 1241	CHIP CAP.	0.1uF	10V	B	GRM36B104K10PT	K22108802		1-	B	d5

MAIN Unit

Parts List

REF	DESCRIPTION	VALUE	V/W	TOL.	MFR'S DESIG	VXSTD P/N	VERS.	LOT	SIDE	LAY ADR
C 1242	CHIP CAP.	0.01uF	16V	B	GRM36B103K16PT	K22128804		1-	B	d5
C 1243	CHIP CAP.	0.01uF	16V	B	GRM36B103K16PT	K22128804		1-	B	d5
C 1244	CHIP TA.CAP.	22uF	6.3V		TEMSVA0J226M-8R	K78080047		1-	B	d5
C 1245	CHIP CAP.	100pF	50V	CH	GRM36CH101J50PT	K22178236		1-	A	C5
C 1246	CHIP CAP.	0.01uF	16V	B	GRM36B103K16PT	K22128804		1-	B	d5
C 1247	CHIP CAP.	0.01uF	16V	B	GRM36B103K16PT	K22128804		1-	B	d5
C 1248	CHIP CAP.	0.1uF	10V	B	GRM36B104K10PT	K22108802		1-	B	f4
C 1249	CHIP CAP.	0.1uF	10V	B	GRM36B104K10PT	K22108802		1-	B	f4
C 1250	CHIP CAP.	0.0022uF	50V	B	GRM36B222K50PT	K22178813		1-	A	A4
C 1251	CHIP CAP.	150pF	50V	CH	GRM36CH151J50PT	K22178240		1-	A	A4
C 1252	CHIP CAP.	0.0022uF	50V	B	GRM36B222K50PT	K22178813		1-	A	A4
C 1253	CHIP CAP.	1uF	10V	F	GRM39F105Z10PT	K22105001		1-	B	f4
C 1255	CHIP CAP.	0.001uF	50V	B	GRM36B102K50PT	K22178809		1-	B	f4
C 1256	CHIP CAP.	0.0047uF	25V	B	GRM36B472K25PT	K22148830		1-	B	f4
C 1257	CHIP CAP.	0.0047uF	25V	B	GRM36B472K25PT	K22148830		1-	B	f4
C 1258	CHIP CAP.	0.0047uF	25V	B	GRM36B472K25PT	K22148830		1-	B	f4
C 1259	CHIP CAP.	0.1uF	10V	B	GRM36B104K10PT	K22108802		1-	B	f4
C 1260	CHIP CAP.	0.1uF	10V	B	GRM36B104K10PT	K22108802		1-	B	f4
C 1261	CHIP CAP.	0.1uF	10V	B	GRM36B104K10PT	K22108802		1-	B	f4
C 1262	CHIP CAP.	0.0022uF	50V	B	GRM36B222K50PT	K22178813		1-	B	f4
C 1263	CHIP CAP.	0.0022uF	50V	B	GRM36B222K50PT	K22178813		1-	B	f4
C 1264	CHIP CAP.	150pF	50V	CH	GRM36CH151J50PT	K22178240		1-	B	f4
C 1265	CHIP CAP.	1uF	10V	F	GRM39F105Z10PT	K22105001		1-	B	f4
C 1266	CHIP CAP.	0.0047uF	25V	B	GRM36B472K25PT	K22148830		1-	B	f4
C 1267	CHIP CAP.	0.0047uF	25V	B	GRM36B472K25PT	K22148830		1-	B	f4
C 1268	CHIP CAP.	0.0047uF	25V	B	GRM36B472K25PT	K22148830		1-	B	f4
C 1269	CHIP CAP.	1uF	10V	F	GRM39F105Z10PT	K22105001		1-	A	B3
C 1270	CHIP CAP.	1uF	10V	F	GRM39F105Z10PT	K22105001		1-	A	B4
C 1271	CHIP CAP.	100pF	50V	CH	GRM36CH101J50PT	K22178236		1-	A	B3
C 1272	CHIP CAP.	0.1uF	10V	B	GRM36B104K10PT	K22108802		1-	A	A3
C 1273	CHIP CAP.	0.1uF	10V	B	GRM36B104K10PT	K22108802		1-	A	B3
C 1274	CHIP CAP.	1uF	10V	F	GRM39F105Z10PT	K22105001		1-	A	A1
C 1275	CHIP CAP.	0.022uF	16V	B	GRM36B223K16PT	K22128806		1-	A	A3
C 1276	CHIP CAP.	0.022uF	16V	B	GRM36B223K16PT	K22128806		1-	A	A3
C 1277	CHIP CAP.	0.022uF	16V	B	GRM36B223K16PT	K22128806		1-	A	A4
C 1278	CHIP CAP.	0.01uF	16V	B	GRM36B103K16PT	K22128804		1-	A	A4
C 1279	CHIP CAP.	0.0047uF	25V	B	GRM36B472K25PT	K22148830		1-	A	A4
C 1280	CHIP CAP.	0.022uF	16V	B	GRM36B223K16PT	K22128806		1-	A	A4
C 1281	CHIP CAP.	0.001uF	50V	B	GRM36B102K50PT	K22178809		1-	A	A4
C 1282	CHIP CAP.	680pF	50V	B	GRM36B681K50PT	K22178807		1-	A	A4
C 1283	CHIP CAP.	0.0068uF	25V	B	GRM36B682J25PT	K22148803		1-	A	A4
C 1284	CHIP CAP.	330pF	50V	B	GRM36B331K50PT	K22178803		1-	A	A4
C 1285	CHIP CAP.	0.47uF	25V	B	GRM40B474K25PT	K22140824		1-	A	A4
C 1286	CHIP CAP.	0.0047uF	25V	B	GRM36B472K25PT	K22148830		1-	A	A4
C 1287	CHIP CAP.	0.022uF	16V	B	GRM36B223K16PT	K22128806		1-	B	f4
C 1288	CHIP CAP.	0.01uF	16V	B	GRM36B103K16PT	K22128804		1-	B	g4
C 1289	CHIP CAP.	0.0047uF	25V	B	GRM36B472K25PT	K22148830		1-	B	g4
C 1290	CHIP CAP.	680pF	50V	B	GRM36B681K50PT	K22178807		1-	B	g4
C 1291	CHIP CAP.	0.001uF	50V	B	GRM36B102K50PT	K22178809		1-	B	g4
C 1292	CHIP CAP.	0.022uF	16V	B	GRM36B223K16PT	K22128806		1-	B	g5
C 1293	CHIP CAP.	0.0068uF	25V	B	GRM36B682J25PT	K22148803		1-	B	g5
C 1294	CHIP CAP.	330pF	50V	B	GRM36B331K50PT	K22178803		1-	B	g5
C 1295	CHIP CAP.	0.0047uF	25V	B	GRM36B472K25PT	K22148830		1-	B	f5
C 1296	CHIP CAP.	0.47uF	25V	B	GRM40B474K25PT	K22140824		1-	B	g5
C 1297	CHIP CAP.	0.001uF	50V	B	GRM36B102K50PT	K22178809		1-	A	B4
C 1298	CHIP CAP.	0.1uF	10V	B	GRM36B104K10PT	K22108802		1-	A	A3
C 1299	CHIP CAP.	1uF	10V	F	GRM39F105Z10PT	K22105001		1-	A	A2
C 1300	CHIP CAP.	0.1uF	10V	B	GRM36B104K10PT	K22108802		1-	A	A3
C 1301	CHIP CAP.	1uF	10V	F	GRM39F105Z10PT	K22105001		1-	A	A2
C 1302	CHIP CAP.	0.001uF	50V	B	GRM36B102K50PT	K22178809		1-	A	A2
C 1303	CHIP TA.CAP.	10uF	10V		TEMSVA1A106M-8R	K78100028		1-	A	A2
C 1304	CHIP TA.CAP.	10uF	10V		TEMSVA1A106M-8R	K78100028		1-	A	B2
C 1305	CHIP CAP.	0.1uF	10V	B	GRM36B104K10PT	K22108802		1-	A	B2
C 1306	CHIP CAP.	0.1uF	10V	B	GRM36B104K10PT	K22108802		1-	A	B2
C 1307	CHIP CAP.	0.001uF	50V	B	GRM36B102K50PT	K22178809		1-	A	A2
C 1310	AL.ELECTRO.CAP.	100uF	16V		16V101M6X7TR2	K46120007		1-	A	A2
C 1312	CHIP CAP.	0.1uF	10V	B	GRM36B104K10PT	K22108802		1-	B	f2
C 1313	AL.ELECTRO.CAP.	220uF	16V		RE2-16V221M 220UF	K40129048		1-	A	A2
C 1314	CHIP CAP.	0.001uF	50V	B	GRM36B102K50PT	K22178809		1-	B	g2
C 1315	CHIP CAP.	0.1uF	16V	B	GRM39B104K16PT	K22124805		1-	B	f2
C 1316	CHIP CAP.	47pF	50V	CH	GRM36CH470J50PT	K22178228		1-	B	f2
C 1317	CHIP CAP.	47pF	50V	CH	GRM36CH470J50PT	K22178228		1-	B	f2
C 1318	CHIP CAP.	47pF	50V	CH	GRM36CH470J50PT	K22178228		1-	B	f3
C 1319	CHIP CAP.	47pF	50V	CH	GRM36CH470J50PT	K22178228		1-	B	f3
C 1320	CHIP CAP.	0.001uF	50V	B	GRM36B102K50PT	K22178809		1-	B	f2
C 1321	CHIP CAP.	0.01uF	16V	B	GRM36B103K16PT	K22128804		1-	B	f5

MAIN Unit

Parts List

REF	DESCRIPTION	VALUE	V/W	TOL.	MFR'S DESIG	VXSTD P/N	VERS.	LOT	SIDE	LAY ADR
C 1322	CHIP CAP.	0.001uF	50V	B	GRM36B102K50PT	K22178809		1-	B	f3
C 1323	CHIP CAP.	0.001uF	50V	B	GRM36B102K50PT	K22178809		1-	B	f3
C 1324	CHIP TA.CAP.	10uF	10V		TEMSVA1A106M-8R	K78100028		1-	B	f3
C 1325	CHIP TA.CAP.	10uF	10V		TEMSVA1A106M-8R	K78100028		1-	B	f3
C 1326	CHIP CAP.	0.001uF	50V	B	GRM36B102K50PT	K22178809		1-	B	f3
C 1327	AL.ELECTRO.CAP.	470uF	10V		SMG10VB470M 470UF	K40109040		1-	A	A3
C 1328	AL.ELECTRO.CAP.	470uF	16V		RE3-16V471M 470UF	K40129066		1-	A	A3
C 1329	CHIP CAP.	0.1uF	16V	B	GRM36B104K16PT	K22124805		1-	B	f3
C 1331	CHIP CAP.	0.01uF	16V	B	GRM36B103K16PT	K22128804		1-	A	B4
C 1332	CHIP CAP.	0.0015uF	50V	B	GRM36B152K50PT	K22178811		1-	A	B4
C 1333	CHIP CAP.	1uF	10V	F	GRM39F105Z10PT	K22105001		1-	A	B1
C 1334	CHIP CAP.	1uF	10V	F	GRM39F105Z10PT	K22105001		1-	A	A1
C 1335	CHIP CAP.	0.1uF	10V	B	GRM36B104K10PT	K22108802		1-	A	B4
C 1336	CHIP CAP.	22pF	50V	CH	GRM36CH220J50PT	K22178220		1-	A	A4
C 1337	CHIP CAP.	1uF	10V	F	GRM39F105Z10PT	K22105001		1-	A	A4
C 1338	CHIP CAP.	1uF	10V	F	GRM39F105Z10PT	K22105001		1-	B	f4
C 1340	AL.ELECTRO.CAP.	10uF	16V		16V100M4X7TR2	K46120004		1-	A	B1
C 1341	CHIP CAP.	0.001uF	50V	B	GRM36B102K50PT	K22178809		1-	B	e1
C 1342	CHIP CAP.	0.01uF	16V	B	GRM36B103K16PT	K22128804		1-	B	e1
C 1343	CHIP CAP.	47pF	50V	CH	GRM36CH470J50PT	K22178228		1-	B	e5
C 1344	CHIP CAP.	47pF	50V	CH	GRM36CH470J50PT	K22178228		1-	B	e5
C 1345	CHIP CAP.	47pF	50V	CH	GRM36CH470J50PT	K22178228		1-	B	e5
C 1346	CHIP CAP.	47pF	50V	CH	GRM36CH470J50PT	K22178228		1-	B	e5
C 1347	CHIP CAP.	47pF	50V	CH	GRM36CH470J50PT	K22178228		1-	B	e5
C 1351	CHIP CAP.	0.001uF	50V	B	GRM36B102K50PT	K22178809		1-	B	e2
C 1352	CHIP TA.CAP.	22uF	16V		TEMSVB21C226M-8R	K78120028		1-	B	e3
C 1353	CHIP CAP.	0.022uF	25V	B	GRM39B223K25PT	K22144807		1-	B	e2
C 1354	CHIP CAP.	0.001uF	50V	B	GRM36B102K50PT	K22178809		1-	B	e1
C 1355	AL.ELECTRO.CAP.	100uF	16V		16V101M6X7TR2	K46120007		1-	A	B2
C 1356	CHIP TA.CAP.	10uF	10V		TEMSVA1A106M-8R	K78100028		1-	A	B2
C 1357	CHIP CAP.	0.001uF	50V	B	GRM36B102K50PT	K22178809		1-	A	B2
C 1358	CHIP CAP.	0.022uF	25V	B	GRM39B223K25PT	K22144807		1-	A	A2
C 1359	CHIP CAP.	100pF	50V	CH	GRM36CH101J50PT	K22178236		1-	A	B1
C 1360	CHIP CAP.	0.47uF	25V	B	GRM40B474K25PT	K22140824		1-	A	B1
C 1361	AL.ELECTRO.CAP.	2200uF	16V		RE3-16V222M 2200UF	K40129064		1-	B	f1
C 1362	CHIP CAP.	0.1uF	10V	B	GRM36B104K10PT	K22108802		1-	B	f1
C 1363	CHIP CAP.	0.001uF	50V	B	GRM36B102K50PT	K22178809		1-	B	f3
C 1364	CHIP TA.CAP.	10uF	10V		TEMSVA1A106M-8R	K78100028		1-	B	f3
C 1365	CHIP CAP.	0.1uF	10V	B	GRM36B104K10PT	K22108802		1-	B	f3
C 1366	CHIP CAP.	0.01uF	16V	B	GRM36B103K16PT	K22128804		1-	B	g3
C 1367	CHIP CAP.	0.01uF	16V	B	GRM36B103K16PT	K22128804		1-	B	f3
C 1368	AL.ELECTRO.CAP.	100uF	16V		16V101M6X7TR2	K46120007		1-	A	A3
C 1369	CHIP CAP.	0.001uF	50V	B	GRM36B102K50PT	K22178809		1-	B	g4
C 1370	CHIP CAP.	0.1uF	10V	B	GRM36B104K10PT	K22108802		1-	B	g4
C 1371	CHIP CAP.	0.001uF	50V	B	GRM36B102K50PT	K22178809		1-	B	g4
C 1372	CHIP CAP.	22pF	50V	CH	GRM36CH220J50PT	K22178220		1-	B	f5
C 1373	CHIP CAP.	10pF	50V	CH	GRM36CH100D50PT	K22178212		1-	B	f5
C 1374	CHIP CAP.	0.001uF	50V	B	GRM36B102K50PT	K22178809		1-	B	f5
C 1375	CHIP CAP.	22pF	50V	CH	GRM36CH220J50PT	K22178220		1-	A	A4
C 1376	CHIP CAP.	0.1uF	10V	B	GRM36B104K10PT	K22108802		1-	A	A4
C 1377	CHIP CAP.	0.001uF	50V	B	GRM36B102K50PT	K22178809		1-	A	A4
C 1378	CHIP CAP.	0.001uF	50V	B	GRM36B102K50PT	K22178809		1-	A	A4
C 1379	CHIP CAP.	39pF	50V	CH	GRM36CH390J50PT	K22178226		1-	A	A4
C 1380	CHIP CAP.	0.022uF	16V	B	GRM36B223K16PT	K22128806		1-	B	f5
C 1381	CHIP CAP.	0.1uF	10V	B	GRM36B104K10PT	K22108802		1-	A	A4
C 1382	CHIP CAP.	0.001uF	50V	B	GRM36B102K50PT	K22178809		1-	A	A4
C 1383	CHIP CAP.	0.001uF	50V	B	GRM36B102K50PT	K22178809		1-	A	B4
C 1384	CHIP CAP.	100pF	50V	CH	GRM36CH101J50PT	K22178236		1-	A	A4
C 1387	CHIP CAP.	1uF	10V	F	GRM39F105Z10PT	K22105001		1-	A	B4
C 1388	CHIP CAP.	0.001uF	50V	B	GRM36B102K50PT	K22178809		1-	A	A4
C 1389	CHIP TA.CAP.	10uF	10V		TEMSVA1A106M-8R	K78100028		1-	B	b5
C 1390	CHIP TA.CAP.	10uF	10V		TEMSVA1A106M-8R	K78100028		1-	B	b5
C 1391	CHIP CAP.	0.001uF	50V	B	GRM36B102K50PT	K22178809		1-	A	E5
C 1392	CHIP CAP.	0.001uF	50V	B	GRM36B102K50PT	K22178809		1-	B	f5
C 1393	CHIP TA.CAP.	10uF	10V		TEMSVA1A106M-8R	K78100028		1-	B	f5
C 1394	CHIP CAP.	0.001uF	50V	B	GRM36B102K50PT	K22178809		1-	B	f5
C 1395	CHIP CAP.	0.001uF	50V	B	GRM36B102K50PT	K22178809		1-	A	B3
C 1396	CHIP CAP.	33pF	50V	CH	GRM36CH330J50PT	K22178224		1-	A	B3
C 1397	CHIP CAP.	0.01uF	16V	B	GRM36B103K16PT	K22128804		1-	B	e4
C 1398	CHIP CAP.	33pF	50V	CH	GRM36CH330J50PT	K22178224		1-	A	B3
C 1399	CHIP CAP.	33pF	50V	CH	GRM36CH330J50PT	K22178224		1-	A	C3
C 1400	CHIP CAP.	47pF	50V	UJ	GRP1553U1H470JZ01E	K22178319		1-	B	e4
C 1401	CHIP CAP.	6pF	50V	UJ	GRP1553U1H6R0DZ01E	K22178307		1-	B	d4
C 1402	CHIP CAP.	0.047uF	10V	B	GRM36B473K10PT	K22108801		1-	A	C3
C 1403	CHIP TA.CAP.	10uF	10V		TEMSVA1A106M-8R	K78100028		1-	A	C4
C 1404	CHIP CAP.	0.001uF	50V	B	GRM36B102K50PT	K22178809		1-	A	C4

MAIN Unit

Parts List

REF	DESCRIPTION	VALUE	V/W	TOL.	MFR'S DESIG	VXSTD P/N	VERS.	LOT	SIDE	LAY ADR
C 1405	CHIP CAP.	1uF	10V	B	GRM40B105K10PT(0.85)	K22100803		1-	B	e3
C 1406	CHIP CAP.	0.01uF	16V	B	GRM36B103K16PT	K22128804		1-	B	d4
C 1407	CHIP CAP.	100pF	50V	CH	GRM36CH101J50PT	K22178236		1-	B	e4
C 1408	CHIP CAP.	1uF	10V	B	GRM40B105K10PT(0.85)	K22100803		1-	B	e4
C 1409	CHIP CAP.	0.01uF	16V	B	GRM36B103K16PT	K22128804		1-	B	e4
C 1410	CHIP CAP.	27pF	50V	UJ	GRP1553U1H270JZ01E	K22178316		1-	B	e4
C 1411	CHIP CAP.	2pF	50V	CK	GRM36CK020B50PT	K22178289		1-	B	e4
C 1412	CHIP CAP.	270pF	25V	CH	GRM36CH271J25PT	K22148248		1-	B	e4
C 1413	CHIP CAP.	0.001uF	50V	B	GRM36B102K50PT	K22178809		1-	B	e4
C 1414	CHIP CAP.	0.001uF	50V	B	GRM36B102K50PT	K22178809		1-	A	C4
C 1415	CHIP CAP.	0.1uF	10V	B	GRM36B104K10PT	K22108802		1-	A	C4
C 1416	CHIP TA.CAP.	10uF	16V		TEMSVB21C106M-8R	K78120025		1-	A	C4
C 1417	CHIP CAP.	0.1uF	16V	B	GRM39B104K16PT	K22124805		1-	A	C4
C 1418	CHIP TA.CAP.	10uF	16V		TEMSVB21C106M-8R	K78120025		1-	A	C4
C 1419	CHIP CAP.	33pF	50V	CH	GRM36CH330J50PT	K22178224		1-	B	c5
C 1420	CHIP CAP.	33pF	50V	CH	GRM36CH330J50PT	K22178224		1-	B	c5
C 1421	CHIP CAP.	33pF	50V	CH	GRM36CH330J50PT	K22178224		1-	B	c5
C 1422	CHIP CAP.	0.001uF	50V	B	GRM36B102K50PT	K22178809		1-	B	c5
C 1423	CHIP CAP.	0.047uF	10V	B	GRM36B473K10PT	K22108801		1-	B	c5
C 1424	CHIP TA.CAP.	10uF	10V		TEMSVA1A106M-8R	K78100028		1-	B	c5
C 1425	CHIP CAP.	0.001uF	50V	B	GRM36B102K50PT	K22178809		1-	B	c5
C 1426	CHIP CAP.	7pF	50V	UJ	GRP1553U1H7R0DZ01E	K22178308		1-	B	c5
C 1427	CHIP CAP.	47pF	50V	UJ	GRP1553U1H470JZ01E	K22178319		1-	B	c5
C 1428	CHIP CAP.	0.001uF	50V	B	GRM36B102K50PT	K22178809		1-	B	d5
C 1429	CHIP CAP.	1uF	10V	B	GRM40B105K10PT(0.85)	K22100803		1-	B	d4
C 1431	CHIP CAP.	0.01uF	16V	B	GRM36B103K16PT	K22128804		1-	B	d5
C 1432	CHIP CAP.	100pF	50V	CH	GRM36CH101J50PT	K22178236		1-	B	d5
C 1433	CHIP CAP.	0.01uF	16V	B	GRM36B103K16PT	K22128804		1-	B	d5
C 1434	CHIP CAP.	68pF	50V	CH	GRM36CH680J50PT	K22178232		1-	B	c5
C 1435	CHIP CAP.	3pF	50V	UJ	GRP1553U1H3R0CZ01E	K22178304		1-	B	c5
C 1436	CHIP CAP.	270pF	25V	CH	GRM36CH271J25PT	K22148248		1-	B	c5
C 1437	CHIP CAP.	0.1uF	10V	B	GRM36B104K10PT	K22108802		1-	B	c5
C 1438	CHIP CAP.	0.1uF	16V	B	GRM39B104K16PT	K22124805		1-	B	c5
C 1439	CHIP TA.CAP.	10uF	16V		TEMSVB21C106M-8R	K78120025		1-	B	d5
C 1440	CHIP CAP.	0.1uF	16V	B	GRM39B104K16PT	K22124805		1-	B	d5
C 1441	CHIP CAP.	0.1uF	16V	B	GRM39B104K16PT	K22124805		1-	B	d5
C 1442	CHIP CAP.	0.001uF	50V	B	GRM36B102K50PT	K22178809		1-	B	d5
C 1444	CHIP CAP.	0.001uF	50V	B	GRM36B102K50PT	K22178809		1-	B	d4
C 1445	CHIP CAP.	0.001uF	50V	B	GRM36B102K50PT	K22178809		1-	B	d4
C 1446	CHIP CAP.	0.001uF	50V	B	GRM36B102K50PT	K22178809		1-	A	D4
C 1447	CHIP CAP.	0.001uF	50V	B	GRM36B102K50PT	K22178809		1-	B	d4
C 1448	CHIP CAP.	0.001uF	50V	B	GRM39B102K50PT	K22174821		1-	B	d4
C 1449	CHIP CAP.	22pF	50V	CH	GRM36CH220J50PT	K22178220		1-	B	d4
C 1450	CHIP CAP.	18pF	50V	CH	GRM36CH180J50PT	K22178218		1-	B	d4
C 1451	CHIP CAP.	10pF	50V	CH	GRM36CH100D50PT	K22178212		1-	B	d4
C 1452	CHIP CAP.	1pF	50V	CK	GRM36CK010B50PT	K22178287		1-	B	d4
C 1453	CHIP CAP.	0.001uF	50V	B	GRM36B102K50PT	K22178809		1-	B	d4
C 1454	CHIP CAP.	0.001uF	50V	B	GRM36B102K50PT	K22178809		1-	B	d4
C 1455	CHIP CAP.	3pF	50V	CJ	GRM36CJ030B50PT	K22178290		1-	A	C4
C 1456	CHIP CAP.	0.1uF	16V	B	GRM39B104K16PT	K22124805		1-	A	C4
C 1458	CHIP CAP.	0.001uF	50V	B	GRM36B102K50PT	K22178809		1-	A	C4
C 1459	CHIP CAP.	0.001uF	50V	B	GRM36B102K50PT	K22178809		1-	A	D4
C 1460	CHIP CAP.	0.001uF	50V	B	GRM36B102K50PT	K22178809		1-	B	d4
C 1461	CHIP CAP.	0.001uF	50V	B	GRM36B102K50PT	K22178809		1-	B	d4
C 1462	CHIP CAP.	0.001uF	50V	B	GRM39B102K50PT	K22174821		1-	B	d4
C 1463	CHIP CAP.	27pF	50V	CH	GRM36CH270J50PT	K22178222		1-	B	d4
C 1464	CHIP CAP.	18pF	50V	CH	GRM36CH180J50PT	K22178218		1-	B	d4
C 1465	CHIP CAP.	18pF	50V	CH	GRM36CH180J50PT	K22178218		1-	B	d4
C 1466	CHIP CAP.	2pF	50V	CK	GRM36CK020B50PT	K22178289		1-	B	d4
C 1467	CHIP CAP.	0.001uF	50V	B	GRM36B102K50PT	K22178809		1-	A	E5
C 1468	CHIP CAP.	0.001uF	50V	B	GRM36B102K50PT	K22178809		1-	B	d4
C 1469	CHIP CAP.	2pF	50V	CK	GRM36CK020B50PT	K22178289		1-	A	C4
C 1471	CHIP CAP.	0.1uF	16V	B	GRM39B104K16PT	K22124805		1-	A	C4
C 1473	CHIP CAP.	0.001uF	50V	B	GRM36B102K50PT	K22178809		1-	A	D5
C 1474	CHIP CAP.	0.001uF	50V	B	GRM39B102K50PT	K22174821		1-	A	D5
C 1475	CHIP CAP.	18pF	50V	CH	GRM36CH180J50PT	K22178218		1-	A	D5
C 1476	CHIP CAP.	12pF	50V	CH	GRM36CH120J50PT	K22178214		1-	A	D5
C 1477	CHIP CAP.	12pF	50V	CH	GRM36CH120J50PT	K22178214		1-	A	D5
C 1478	CHIP CAP.	1pF	50V	CK	GRM36CK010B50PT	K22178287		1-	A	D5
C 1479	CHIP CAP.	0.001uF	50V	B	GRM36B102K50PT	K22178809		1-	B	c5
C 1480	CHIP CAP.	0.001uF	50V	B	GRM36B102K50PT	K22178809		1-	A	D5
C 1481	CHIP CAP.	2pF	50V	CK	GRM36CK020B50PT	K22178289		1-	A	E5
C 1482	CHIP CAP.	0.001uF	50V	B	GRM36B102K50PT	K22178809		1-	A	D5
C 1483	CHIP CAP.	0.001uF	50V	B	GRM36B102K50PT	K22178809		1-	A	D5
C 1484	CHIP CAP.	0.001uF	50V	B	GRM39B102K50PT	K22174821		1-	A	D5
C 1485	CHIP CAP.	27pF	50V	CH	GRM36CH270J50PT	K22178222		1-	A	D5

MAIN Unit

Parts List

REF	DESCRIPTION	VALUE	V/W	TOL.	MFR'S DESIG	VXSTD P/N	VERS.	LOT	SIDE	LAY ADR
C 1486	CHIP CAP.	0.001uF	50V	B	GRM36B102K50PT	K22178809		1-	A	D5
C 1487	CHIP CAP.	18pF	50V	CH	GRM36CH180J50PT	K22178218		1-	A	D5
C 1488	CHIP CAP.	18pF	50V	CH	GRM36CH180J50PT	K22178218		1-	A	D5
C 1489	CHIP CAP.	2pF	50V	CK	GRM36CK020B50PT	K22178289		1-	A	D5
C 1490	CHIP CAP.	0.001uF	50V	B	GRM36B102K50PT	K22178809		1-	A	D5
C 1491	CHIP CAP.	0.001uF	50V	B	GRM36B102K50PT	K22178809		1-	A	D5
C 1492	CHIP CAP.	1.5pF	50V	CK	GRM36CK1R5B50PT	K22178288		1-	A	E5
C 1493	CHIP CAP.	0.001uF	50V	B	GRM36B102K50PT	K22178809		1-	A	E4
C 1500	CHIP CAP.	0.001uF	50V	B	GRM36B102K50PT	K22178809		1-	B	c4
C 1501	CHIP CAP.	0.0047uF	25V	B	GRM36B472K25PT	K22148830		1-	B	c4
C 1502	CHIP CAP.	0.001uF	50V	B	GRM36B102K50PT	K22178809		1-	B	c4
C 1503	CHIP CAP.	0.01uF	50V	B	GRM39B103M50PT	K22174823		1-	B	c4
C 1504	CHIP CAP.	100pF	50V	CH	GRM36CH101J50PT	K22178236		1-	B	c4
C 1506	CHIP CAP.	0.0047uF	25V	B	GRM36B472K25PT	K22148830		1-	B	c5
C 1507	CHIP CAP.	0.0047uF	25V	B	GRM36B472K25PT	K22148830		1-	B	c5
C 1508	CHIP CAP.	68pF	50V	CH	GRM36CH680J50PT	K22178232		1-	B	c4
C 1509	CHIP CAP.	68pF	50V	CH	GRM36CH680J50PT	K22178232		1-	B	c4
C 1510	CHIP CAP.	5pF	50V	CH	GRM36CH050B50PT	K22178292		1-	B	c4
C 1511	CHIP CAP.	0.0047uF	25V	B	GRM36B472K25PT	K22148830		1-	A	E4
C 1512	CHIP CAP.	0.0047uF	25V	B	GRM36B472K25PT	K22148830		1-	B	c4
C 1513	CHIP CAP.	8pF	50V	CH	GRM36CH080B50PT	K22178295		1-	B	b4
C 1514	CHIP CAP.	0.001uF	50V	B	GRM36B102K50PT	K22178809		1-	B	c5
C 1515	CHIP CAP.	0.001uF	50V	B	GRM36B102K50PT	K22178809		1-	B	c4
C 1516	CHIP CAP.	0.01uF	50V	B	GRM39B103M50PT	K22174823		1-	B	b4
C 1517	CHIP CAP.	100pF	50V	CH	GRM36CH101J50PT	K22178236		1-	B	c4
C 1518	CHIP CAP.	47pF	50V	CH	GRM36CH470J50PT	K22178228		1-	B	c4
C 1519	CHIP CAP.	47pF	50V	CH	GRM36CH470J50PT	K22178228		1-	B	b4
C 1520	CHIP CAP.	5pF	50V	CH	GRM36CH050B50PT	K22178292		1-	B	b4
C 1521	CHIP CAP.	0.0047uF	25V	B	GRM36B472K25PT	K22148830		1-	A	E5
C 1522	CHIP CAP.	0.0047uF	25V	B	GRM36B472K25PT	K22148830		1-	B	c5
C 1523	CHIP CAP.	5pF	50V	CH	GRM36CH050C50PT	K22178207		1-	A	E5
C 1524	CHIP CAP.	0.0047uF	25V	B	GRM36B472K25PT	K22148830		1-	A	E5
C 1525	CHIP CAP.	1pF	50V	CK	GRM36CK010B50PT	K22178287		1-	A	E5
C 1526	CHIP CAP.	7pF	50V	CH	GRM36CH070B50PT	K22178294		1-	A	D4
C 1527	CHIP CAP.	0.001uF	50V	B	GRM36B102K50PT	K22178809		1-	A	B3
C 1528	CHIP CAP.	0.001uF	50V	B	GRM39B102K50PT	K22174821		1-	A	D3
C 1529	CHIP CAP.	0.001uF	50V	B	GRM36B102K50PT	K22178809		1-	A	D3
C 1530	FILM CAP.	12pF	500V		UC232H0120J-T	K33279020		1-	A	D2
C 1532	CHIP CAP.	100pF	200V	CH	GRM40CH101J200PT	K22230228		1-	A	E2
C 1533	CHIP CAP.	100pF	200V	CH	GRM40CH101J200PT	K22230228		1-	A	E2
C 1535	CHIP CAP.	0.001uF	50V	B	GRM36B102K50PT	K22178809		1-	A	E1
C 1538	CHIP CAP.	0.5pF	200V	CK	GRM1884C2DR50CY21D	K22234201		1-	B	b2
C 1540	CHIP CAP.	2pF	200V	CK	GRM1884C2D2R0CV01D	K22234204		1-	A	E2
C 1541	CHIP CAP.	0.001uF	50V	B	GRM36B102K50PT	K22178809		1-	B	b2
C 1542	CHIP CAP.	6pF	50V	CH	GRM36CH060B50PT	K22178293		1-	B	b2
C 1543	CHIP CAP.	0.5pF	200V	CK	GRM1884C2DR50CY21D	K22234201		1-	B	b2
C 1544	CHIP CAP.	0.001uF	50V	B	GRM36B102K50PT	K22178809		1-	B	b2
C 1545	CHIP CAP.	6pF	50V	CH	GRM36CH060B50PT	K22178293		1-	B	b2
C 1546	CHIP CAP.	3pF	200V	CJ	GRM1883C2D3R0CV01D	K22234205		1-	A	E2
C 1547	CHIP CAP.	4pF	200V	CH	GRM1882C2D4R0CV01D	K22234206		1-	A	E2
C 1548	CHIP CAP.	1pF	200V	CK	GRM1884C2D1R0CV01D	K22234203		1-	A	F2
C 1549	CHIP CAP.	2pF	200V	CK	GRM1884C2D2R0CV01D	K22234204		1-	A	F3
C 1550	CHIP CAP.	4pF	200V	CH	GRM1882C2D4R0CV01D	K22234206		1-	A	F3
C 1551	CHIP CAP.	4pF	200V	CH	GRM1882C2D4R0CV01D	K22234206		1-	A	F3
C 1553	CHIP CAP.	2pF	200V	CK	GRM1884C2D2R0CV01D	K22234204		1-	A	F3
C 1554	CHIP CAP.	2pF	200V	CK	GRM1884C2D2R0CV01D	K22234204		1-	A	F3
C 1555	CHIP CAP.	4pF	200V	CH	GRM1882C2D4R0CV01D	K22234206		1-	A	F3
C 1556	CHIP CAP.	4pF	200V	CH	GRM1882C2D4R0CV01D	K22234206		1-	A	F3
C 1557	CHIP CAP.	15pF	200V	CH	GRM40CH150J200PT	K22230218		1-	B	a2
C 1558	CHIP CAP.	15pF	200V	CH	GRM40CH150J200PT	K22230218		1-	B	a2
C 1561	CHIP CAP.	22pF	50V	CH	GRM36CH220J50PT	K22178220		1-	B	a1
C 1562	CHIP CAP.	0.01uF	50V	B	GRM39B103M50PT	K22174823		1-	B	c1
C 1563	CHIP CAP.	0.001uF	50V	B	GRM36B102K50PT	K22178809		1-	B	b2
C 1564	CHIP CAP.	47pF	50V	CH	GRM36CH470J50PT	K22178228		1-	A	E1
C 1566	FILM CAP.	56pF	500V		UC232H0560J-T	K33279035		1-	A	D1
C 1567	FILM CAP.	68pF	500V		UC232H0680J-T	K33279030		1-	A	D1
C 1568	CHIP CAP.	33pF	200V	CH	GRM40CH330J200PT	K22230222		1-	B	c1
C 1569	CHIP CAP.	27pF	200V	CH	GRM40CH270J200PT	K22230221		1-	B	b1
C 1570	CHIP CAP.	0.0047uF	25V	B	GRM36B472K25PT	K22148830		1-	B	c3
C 1571	CHIP CAP.	0.001uF	50V	B	GRM36B102K50PT	K22178809		1-	B	b1
C 1572	CHIP CAP.	1pF	200V	CK	GRM1884C2D1R0CV01D	K22234203		1-	B	b1
C 1573	CHIP CAP.	8pF	50V	CH	GRM36CH080B50PT	K22178295		1-	B	b1
C 1574	CHIP CAP.	22pF	200V	CH	GRM40CH220J200PT	K22230220		1-	A	E1
C 1575	CHIP CAP.	27pF	200V	CH	GRM40CH270J200PT	K22230221		1-	A	E1
C 1576	CHIP CAP.	7pF	200V	CH	GRM1882C2D7R0DV01D	K22234209		1-	B	b1
C 1577	CHIP CAP.	5pF	200V	CH	GRM1882C2D5R0CV01D	K22234207		1-	B	b1

MAIN Unit

Parts List

REF	DESCRIPTION	VALUE	V/W	TOL.	MFR'S DESIG	VXSTD P/N	VERS.	LOT	SIDE	LAY ADR
C 1578	CHIP CAP.	12pF	200V	CH	GRM40CH120J200PT	K22230217		1-	B	b1
C 1579	CHIP CAP.	0.001uF	50V	B	GRM36B102K50PT	K22178809		1-	B	b1
C 1581	CHIP CAP.	3pF	200V	CJ	GRM1883C2D3R0CV01D	K22234205		1-	B	a1
C 1582	CHIP CAP.	0.5pF	200V	CK	GRM1884C2DR50CY21D	K22234201		1-	B	a1
C 1583	CHIP CAP.	6pF	50V	CH	GRM36CH060B50PT	K22178293		1-	B	a1
C 1584	CHIP CAP.	0.001uF	50V	B	GRM36B102K50PT	K22178809		1-	B	a1
C 1585	CHIP CAP.	15pF	200V	CH	GRM40CH150J200PT	K22230218		1-	B	a2
C 1586	CHIP CAP.	15pF	200V	CH	GRM40CH150J200PT	K22230218		1-	B	a2
C 1587	CHIP CAP.	15pF	200V	CH	GRM40CH150J200PT	K22230218		1-	B	a2
C 1588	CHIP CAP.	15pF	200V	CH	GRM40CH150J200PT	K22230218		1-	B	a2
C 1589	CHIP CAP.	33pF	200V	CH	GRM40CH330J200PT	K22230222		1-	A	F3
C 1590	CHIP CAP.	33pF	200V	CH	GRM40CH330J200PT	K22230222		1-	A	F3
C 1592	FILM CAP.	330pF	100V		UC232A3300J-T	K33209029		1-	A	D3
C 1593	FILM CAP.	330pF	100V		UC232A3300J-T	K33209029		1-	A	D2
C 1594	CHIP CAP.	220pF	200V	CH	GRM40CH221J200PT	K22230232		1-	A	E2
C 1595	CHIP CAP.	220pF	200V	CH	GRM40CH221J200PT	K22230232		1-	A	D2
C 1596	CHIP CAP.	220pF	200V	CH	GRM40CH221J200PT	K22230232		1-	A	E2
C 1597	CHIP CAP.	220pF	200V	CH	GRM40CH221J200PT	K22230232		1-	A	D2
C 1598	CHIP CAP.	220pF	200V	CH	GRM40CH221J200PT	K22230232		1-	A	E2
C 1599	CHIP CAP.	0.001uF	50V	B	GRM36B102K50PT	K22178809		1-	B	b3
C 1600	CHIP CAP.	220pF	200V	CH	GRM40CH221J200PT	K22230232		1-	B	b2
C 1601	CHIP CAP.	220pF	200V	CH	GRM40CH221J200PT	K22230232		1-	B	b3
C 1602	CHIP CAP.	220pF	200V	CH	GRM40CH221J200PT	K22230232		1-	B	b2
C 1603	FILM CAP.	100pF	500V		UC232H1000J-T	K33279048		1-	B	c2
C 1604	FILM CAP.	330pF	100V		UC232A3300J-T	K33209029		1-	B	c2
C 1605	CHIP CAP.	0.5pF	200V	CK	GRM1884C2DR50CY21D	K22234201		1-	B	b3
C 1606	CHIP CAP.	0.001uF	50V	B	GRM36B102K50PT	K22178809		1-	B	c3
C 1607	CHIP CAP.	4pF	50V	CH	GRM36CH040B50PT	K22178291		1-	B	b3
C 1608	CHIP CAP.	0.001uF	50V	B	GRM36B102K50PT	K22178809		1-	B	b3
C 1609	CHIP CAP.	0.001uF	50V	B	GRM36B102K50PT	K22178809		1-	B	a1
C 1611	CHIP CAP.	56pF	200V	CH	GRM40CH560J200PT	K22230225		1-	A	D2
C 1613	CHIP CAP.	0.5pF	200V	CK	GRM1884C2DR50CY21D	K22234201		1-	B	c3
C 1614	CHIP CAP.	0.001uF	50V	B	GRM36B102K50PT	K22178809		1-	B	c3
C 1615	CHIP CAP.	6pF	50V	CH	GRM36CH060B50PT	K22178293		1-	B	c3
C 1616	CHIP CAP.	100pF	200V	CH	GRM40CH101J200PT	K22230228		1-	B	c3
C 1617	CHIP CAP.	120pF	200V	CH	GRM40CH121J200PT	K22230229		1-	B	c3
C 1618	CHIP CAP.	56pF	200V	CH	GRM40CH560J200PT	K22230225		1-	B	b3
C 1619	CHIP CAP.	56pF	200V	CH	GRM40CH560J200PT	K22230225		1-	B	b3
C 1620	CHIP CAP.	0.001uF	50V	B	GRM36B102K50PT	K22178809		1-	B	a4
C 1621	CHIP CAP.	0.5pF	200V	CK	GRM1884C2DR50CY21D	K22234201		1-	B	c2
C 1622	CHIP CAP.	5pF	50V	CH	GRM36CH050B50PT	K22178292		1-	B	c2
C 1623	CHIP CAP.	0.001uF	50V	B	GRM36B102K50PT	K22178809		1-	B	c2
C 1624	CHIP CAP.	27pF	200V	CH	GRM40CH270J200PT	K22230221		1-	B	b2
C 1625	CHIP CAP.	33pF	200V	CH	GRM40CH330J200PT	K22230222		1-	B	a3
C 1626	CHIP CAP.	27pF	200V	CH	GRM40CH270J200PT	K22230221		1-	B	a3
C 1627	CHIP CAP.	0.001uF	50V	B	GRM36B102K50PT	K22178809		1-	B	b3
C 1628	CHIP CAP.	8pF	50V	CH	GRM36CH080B50PT	K22178295		1-	B	b3
C 1629	CHIP CAP.	0.5pF	200V	CK	GRM1884C2DR50CY21D	K22234201		1-	B	b3
C 1630	CHIP CAP.	0.001uF	50V	B	GRM36B102K50PT	K22178809		1-	B	a4
C 1631	CHIP CAP.	0.001uF	50V	B	GRM36B102K50PT	K22178809		1-	B	c3
C 1632	CHIP CAP.	0.001uF	50V	B	GRM36B102K50PT	K22178809		1-	B	a1
C 1633	CHIP CAP.	0.001uF	50V	B	GRM36B102K50PT	K22178809		1-	B	a1
C 1634	CHIP CAP.	0.001uF	50V	B	GRM36B102K50PT	K22178809		1-	B	e3
C 1635	CHIP CAP.	0.0047uF	25V	B	GRM36B472K25PT	K22148830		1-	B	c3
C 1636	CHIP CAP.	0.0047uF	25V	B	GRM36B472K25PT	K22148830		1-	B	b2
C 1637	CHIP CAP.	0.001uF	50V	B	GRM36B102K50PT	K22178809		1-	B	e3
C 1638	CHIP TA.CAP.	10uF	10V		TEMSVA1A106M-8R	K78100028		1-	B	e3
C 1639	CHIP CAP.	0.1uF	10V	B	GRM36B104K10PT	K22108802		1-	B	e3
C 1640	CHIP CAP.	0.001uF	50V	B	GRM36B102K50PT	K22178809		1-	B	e3
C 1641	CHIP CAP.	0.001uF	50V	B	GRM36B102K50PT	K22178809		1-	B	e3
C 1642	CHIP CAP.	0.001uF	50V	B	GRM36B102K50PT	K22178809		1-	B	e3
C 1643	CHIP CAP.	22pF	50V	CH	GRM36CH220J50PT	K22178220		1-	B	f3
C 1644	CHIP CAP.	0.001uF	50V	B	GRM36B102K50PT	K22178809		1-	B	e3
C 1645	CHIP CAP.	0.001uF	50V	B	GRM36B102K50PT	K22178809		1-	B	f3
C 1661	CHIP CAP.	100pF	200V	CH	GRM40CH101J200PT	K22230228		1-	B	d1
C 1662	CHIP CAP.	0.001uF	50V	B	GRM39B102K50PT	K22174821		1-	B	d1
C 1663	CHIP CAP.	0.47uF	25V	B	GRM40B474K25PT	K22140824		1-	B	d1
C 1664	CHIP TA.CAP.	1uF	25V		TEMSVA1E105M-8R	K78140013		1-	B	e1
C 1665	FILM CAP.	47pF	500V		UC232H0470J-T	K33279034		1-	A	D1
C 1666	FILM CAP.	47pF	500V		UC232H0470J-T	K33279034		1-	A	D2
C 1667	FILM CAP.	39pF	500V		UC232H0390J-T	K33279038		1-	A	C1
C 1668	FILM CAP.	47pF	500V		UC232H0470J-T	K33279034		1-	A	C2
C 1669	CHIP CAP.	0.001uF	50V	B	GRM39B102K50PT	K22174821		1-	B	e1
C 1670	CHIP CAP.	0.1uF	16V	B	GRM39B104K16PT	K22124805		1-	B	e1
C 1671	CHIP CAP.	0.01uF	50V	B	GRM39B103M50PT	K22174823		1-	B	e2
C 1672	CHIP CAP.	47pF	50V	CH	GRM36CH470J50PT	K22178228		1-	A	B2

MAIN Unit

Parts List

REF	DESCRIPTION	VALUE	V/W	TOL.	MFR'S DESIG	VXSTD P/N	VERS.	LOT	SIDE	LAY ADR
C 1673	CHIP CAP.	0.47uF	25V	B	GRM40B474K25PT	K22140824		1-	A	C3
C 1674	CHIP CAP.	0.001uF	50V	B	GRM39B102K50PT	K22174821		1-	A	C3
C 1675	CHIP CAP.	0.022uF	25V	B	GRM39B223K25PT	K22144807		1-	A	C3
C 1676	CHIP CAP.	0.47uF	25V	B	GRM40B474K25PT	K22140824		1-	A	B3
C 1677	CHIP CAP.	0.001uF	50V	B	GRM39B102K50PT	K22174821		1-	A	B3
C 1678	CHIP CAP.	100pF	50V	CH	GRM39CH101J50PT	K22174235		1-	A	B2
C 1679	CHIP CAP.	100pF	50V	CH	GRM39CH101J50PT	K22174235		1-	A	B2
C 1680	CHIP CAP.	220pF	200V	CH	GRM40CH221J200PT	K22230232		1-	A	B2
C 1681	CHIP CAP.	0.0047uF	50V	B	GRM39B472K50PT	K22174833		1-	A	B2
C 1682	CHIP CAP.	82pF	50V	CH	GRM39CH820J50PT	K22174233		1-	A	B2
C 1683	CHIP CAP.	12pF	50V	CH	GRM36CH120J50PT	K22178214		1-	A	C2
C 1684	FILM CAP.	56pF	500V		UC232H0560J-T	K33279035		1-	A	C2
C 1685	CHIP CAP.	470pF	50V	CH	GRM39CH471J50PT	K22174249		1-	A	C2
C 1686	CHIP CAP.	10pF	50V	CH	GRM36CH100D50PT	K22178212		1-	A	C2
C 1687	CHIP CAP.	22pF	50V	CH	GRM39CH220J50PT	K22174219		1-	A	C2
C 1688	CHIP CAP.	15pF	50V	CH	GRM39CH150J50PT	K22174215		1-	A	B2
C 1689	CHIP CAP.	33pF	50V	CH	GRM39CH330J50PT	K22174223		1-	A	B2
C 1690	CHIP CAP.	15pF	50V	CH	GRM39CH150J50PT	K22174215		1-	A	C1
C 1691	CHIP CAP.	27pF	50V	CH	GRM39CH270J50PT	K22174221		1-	A	C2
C 1692	CHIP CAP.	39pF	50V	CH	GRM39CH390J50PT	K22174225		1-	A	C2
C 1693	CHIP CAP.	10pF	50V	CH	GRM39CH100D50PT	K22174211		1-	A	C2
C 1694	CHIP CAP.	27pF	50V	CH	GRM39CH270J50PT	K22174221		1-	A	C2
C 1695	CHIP CAP.	0.001uF	50V	B	GRM39B102K50PT	K22174821		1-	A	D3
C 1696	CHIP CAP.	0.47uF	25V	B	GRM40B474K25PT	K22140824		1-	A	D3
C 1697	CHIP CAP.	1uF	16V	B	GRM42-6B105K16NPT	K22121803		1-	B	d2
C 1698	CHIP CAP.	0.001uF	50V	B	GRM39B102K50PT	K22174821		1-	B	d2
C 1699	CHIP CAP.	1uF	16V	B	GRM42-6B105K16NPT	K22121803		1-	B	e2
C 1700	CHIP CAP.	0.001uF	50V	B	GRM39B102K50PT	K22174821		1-	B	e3
C 1701	CHIP CAP.	0.1uF	16V	B	GRM39B104K16PT	K22124805		1-	B	d3
C 1702	CHIP CAP.	0.001uF	50V	B	GRM36B102K50PT	K22178809		1-	B	d3
C 1703	CHIP CAP.	0.001uF	50V	B	GRM36B102K50PT	K22178809		1-	A	C2
C 1704	CHIP CAP.	0.47uF	25V	B	GRM40B474K25PT	K22140824		1-	A	C3
C 1705	CHIP CAP.	0.47uF	25V	B	GRM40B474K25PT	K22140824		1-	A	D3
C 1706	CHIP CAP.	0.001uF	50V	B	GRM36B102K50PT	K22178809		1-	A	D3
C 1707	CHIP CAP.	0.001uF	50V	B	GRM36B102K50PT	K22178809		1-	A	C3
C 1708	CHIP CAP.	0.001uF	50V	B	GRM36B102K50PT	K22178809		1-	B	d3
C 1709	CHIP CAP.	0.001uF	50V	B	GRM36B102K50PT	K22178809		1-	B	c3
C 1710	CHIP CAP.	0.001uF	50V	B	GRM36B102K50PT	K22178809		1-	B	d3
C 1711	CHIP CAP.	0.001uF	50V	B	GRM36B102K50PT	K22178809		1-	B	d3
C 1712	CHIP CAP.	15pF	50V	CH	GRM36CH150J50PT	K22178216		1-	B	d3
C 1713	CHIP CAP.	0.001uF	50V	B	GRM36B102K50PT	K22178809		1-	A	C3
C 1715	CHIP CAP.	0.001uF	50V	B	GRM36B102K50PT	K22178809		1-	A	D3
C 1716	CHIP CAP.	0.001uF	50V	B	GRM36B102K50PT	K22178809		1-	A	D3
C 1717	CHIP CAP.	0.022uF	16V	B	GRM36B223K16PT	K22128806		1-	A	D3
C 1718	CHIP CAP.	100pF	50V	CH	GRM36CH101J50PT	K22178236		1-	B	d3
C 1719	CHIP CAP.	18pF	50V	CH	GRM36CH180J50PT	K22178218		1-	A	C3
C 1720	CHIP CAP.	0.001uF	50V	B	GRM36B102K50PT	K22178809		1-	B	d3
C 1721	CHIP CAP.	0.01uF	16V	B	GRM36B103K16PT	K22128804		1-	B	e3
C 1722	CHIP CAP.	0.022uF	25V	B	GRM39B223K25PT	K22144807		1-	B	d3
C 1723	CHIP CAP.	0.001uF	50V	B	GRM36B102K50PT	K22178809		1-	B	d3
C 1724	CHIP CAP.	0.001uF	50V	B	GRM36B102K50PT	K22178809		1-	A	C3
C 1725	CHIP CAP.	10pF	50V	CH	GRM36CH100D50PT	K22178212		1-	A	C3
C 1726	CHIP CAP.	12pF	50V	CH	GRM36CH120J50PT	K22178214		1-	A	C3
C 1727	CHIP CAP.	33pF	50V	CH	GRM36CH330J50PT	K22178224		1-	A	C3
C 1728	CHIP CAP.	82pF	50V	CH	GRM36CH820J50PT	K22178234		1-	A	C3
C 1729	CHIP CAP.	47pF	50V	CH	GRM36CH470J50PT	K22178228		1-	B	d3
C 1730	CHIP CAP.	150pF	50V	CH	GRM36CH151J50PT	K22178240		1-	B	d3
C 1731	CHIP CAP.	120pF	50V	CH	GRM36CH121J50PT	K22178238		1-	B	d3
C 1732	CHIP CAP.	68pF	50V	CH	GRM36CH680J50PT	K22178232		1-	B	d3
C 1733	CHIP CAP.	82pF	50V	CH	GRM36CH820J50PT	K22178234		1-	B	d3
C 1734	CHIP CAP.	270pF	25V	CH	GRM36CH271J25PT	K22148248		1-	B	d3
C 1735	CHIP CAP.	150pF	50V	CH	GRM36CH151J50PT	K22178240		1-	B	d3
C 1777	CHIP CAP.	1uF	10V	F	GRM39F105Z10PT	K22105001		1-	B	e5
C 1778	CHIP TA. CAP.	22uF	6.3V		TEMSVA0J226M-8R	K78080047		1-	B	f2
C 1779	CHIP CAP.	0.1uF	10V	B	GRM36B104K10PT	K22108802		1-	B	f3
C 1780	CHIP CAP.	0.001uF	50V	B	GRM36B102K50PT	K22178809		1-	A	F3
C 1782	CHIP CAP.	0.001uF	50V	B	GRM36B102K50PT	K22178809		1-	A	D4
C 1783	CHIP CAP.	0.001uF	50V	B	GRM36B102K50PT	K22178809		1-	A	D4
C 1784	CHIP CAP.	0.01uF	16V	B	GRM36B103K16PT	K22128804		1-	A	D4
C 1785	CHIP CAP.	30pF	50V	CH	GRM36CH300J50PT	K22178223		1-	B	b2
C 1787	CHIP CAP.	0.01uF	16V	B	GRM36B103K16PT	K22128804		1-	B	d5
C 1788	CHIP CAP.	0.1uF	10V	B	GRM36B104K10PT	K22108802		1-	B	e5
C 1789	CHIP CAP.	56pF	50V	CH	GRM36CH560J50PT	K22178230		1-	A	F3
C 1790	CHIP CAP.	0.01uF	16V	B	GRM36B103K16PT	K22128804		1-	B	c5
C 1791	CHIP CAP.	0.01uF	16V	B	GRM36B103K16PT	K22128804		1-	A	C4
C 1793	CHIP CAP.	0.001uF	50V	B	GRM36B102K50PT	K22178809		1-	B	b5

MAIN Unit

Parts List

REF	DESCRIPTION	VALUE	V/W	TOL.	MFR'S DESIG	VXSTD P/N	VERS.	LOT	SIDE	LAY ADR
C 1794	CHIP CAP.	0.001uF	50V	B	GRM36B102K50PT	K22178809		1-	A	C4
C 1795	CHIP CAP.	0.5pF	50V	CK	GRM36CK0R5B50PT	K22178285		1-	A	F5
C 1796	CHIP CAP.	0.5pF	50V	CK	GRM36CK0R5B50PT	K22178285		1-	B	c4
C 1797	CHIP CAP.	0.5pF	50V	CK	GRM36CK0R5B50PT	K22178285		1-	B	a5
C 1798	CHIP CAP.	30pF	50V	CH	GRM36CH300J50PT	K22178223		1-	B	b2
C 1799	CHIP CAP.	4pF	50V	CH	GRM36CH040B50PT	K22178291		1-	B	c1
C 1801	CHIP CAP.	5pF	200V	CH	GRM1882C2D5R0CV01D	K22234207		1-	A	D1
C 1802	CHIP CAP.	2pF	50V	CK	GRM36CK020B50PT	K22178289		1-	B	d2
C 1803	CHIP CAP.	1.5pF	50V	CK	GRM36CK1R5B50PT	K22178288		1-	B	d3
C 1804	CHIP CAP.	0.5pF	200V	CK	GRM1884C2DR50CY21D	K22234201		1-	A	F3
C 1805	CHIP CAP.	0.001uF	50V	B	GRM36B102K50PT	K22178809		1-	B	e4
C 1806	CHIP CAP.	0.001uF	50V	B	GRM36B102K50PT	K22178809		1-	A	C4
C 1807	CHIP CAP.	7pF	50V	CH	GRM36CH070B50PT	K22178294		1-	B	d3
C 1808	CHIP CAP.	0.0047uF	50V	B	GRM39B472K50PT	K22174833		1-	A	B2
C 1809	CHIP CAP.	6pF	50V	CH	GRM36CH060B50PT	K22178293		1-	A	B4
C 1810	CHIP CAP.	0.1uF	10V	B	GRM36B104K10PT	K22108802		1-	B	d5
C 1811	CHIP TA.CAP.	1uF	25V		TEMSVA1E105M-8R	K78140013		1-	A	D3
C 1813	CHIP CAP.	22pF	50V	CH	GRM36CH220J50PT	K22178220		1-	A	C5
C 1814	CHIP CAP.	3pF	50V	CJ	GRM36CJ030B50PT	K22178290		1-	B	f5
C 1815	CHIP CAP.	10pF	50V	CH	GRM36CH100D50PT	K22178212		1-	B	a4
C 1817	CHIP CAP.	0.001uF	50V	B	GRM36B102K50PT	K22178809		1-	B	c4
C 1818	CHIP CAP.	0.001uF	50V	B	GRM36B102K50PT	K22178809		1-	A	E4
C 1819	CHIP CAP.	0.001uF	50V	B	GRM36B102K50PT	K22178809		1-	A	B4
C 1821	CHIP CAP.	1pF	200V	CK	GRM1884C2D1R0CV01D	K22234203		1-	B	a3
C 1822	CHIP TA.CAP.	10uF	10V		TEMSVA1A106M-8R	K78100028		1-	A	F5
C 1823	CHIP TA.CAP.	10uF	10V		TEMSVA1A106M-8R	K78100028		1-	A	E5
C 1824	CHIP CAP.	3pF	200V	CJ	GRM1883C2D3R0CV01D	K22234205		1-		
C 1827	CHIP CAP.	0.001uF	50V	B	GRM36B102K50PT	K22178809		1-		
C 1828	CHIP CAP.	43pF	50V	CH	UMK105CH430JW-F	K22178273		1-		
C 1829	CHIP CAP.	4pF	50V	CH	GRM39CH040C50PT	K22174205		1-		
C 1830	CHIP CAP.	1pF	50V	CK	GRM39CK010B50PT	K22174267		1-		
C 1838	CHIP CAP.	3pF	50V	CJ	GRM36CJ030B50PT	K22178290		1-		
CD1001	CERAMIC DISC				CDBM450C24	H7901390		1-	A	B4
CD1002	CERAMIC DISC				CDBM450C24	H7901390		1-	A	C5
CF1001	CERAMIC FILTER				CFWM450E	H3900466		1-	A	B3
CF1002	CERAMIC FILTER				CFWM450E	H3900466		1-	A	C5
CF1003	CERAMIC FILTER				CFWM450G	H3900435		1-	A	C5
D 1001	DIODE				RLS135 TE-11	G2070128		1-	B	b2
D 1002	DIODE				RLS135 TE-11	G2070128		1-	B	b2
D 1003	DIODE				1SS302 TE85R	G2070088		1-	B	b3
D 1004	DIODE				HVC358B(TAPE)	G2070590		1-	B	c4
D 1005	DIODE				HVC358B(TAPE)	G2070590		1-	B	c4
D 1006	DIODE				HVC358B(TAPE)	G2070590		1-	B	c4
D 1007	DIODE				HVC131TRF	G2070676		1-	A	F4
D 1008	DIODE				HSC277TRF	G2070584		1-	A	F4
D 1009	DIODE				HVC358B(TAPE)	G2070590		1-	A	F4
D 1010	DIODE				HVC358B(TAPE)	G2070590		1-	A	F5
D 1011	DIODE				HVC358B(TAPE)	G2070590		1-	A	F5
D 1012	DIODE				HVC131TRF	G2070676		1-	A	F5
D 1013	DIODE				HVC131TRF	G2070676		1-	A	F5
D 1016	DIODE				HVC365 TRF	G2070902		1-	B	b4
D 1017	DIODE				HVC365 TRF	G2070902		1-	B	c4
D 1018	DIODE				HVC365 TRF	G2070902		1-	B	c4
D 1019	DIODE				HVC365 TRF	G2070902		1-	B	a5
D 1020	DIODE				HVC365 TRF	G2070902		1-	B	a5
D 1021	DIODE				HVC365 TRF	G2070902		1-	B	a5
D 1022	DIODE				HSC277TRF	G2070584		1-	B	a5
D 1024	DIODE				DAN222 TL	G2070174		1-	B	a5
D 1025	DIODE				1SS302 TE85R	G2070088		1-	B	a4
D 1026	DIODE				1SS302 TE85R	G2070088		1-	A	G4
D 1027	DIODE				HSC277TRF	G2070584		1-	B	a5
D 1028	DIODE				HSC277TRF	G2070584		1-	A	G5
D 1029	DIODE				HVC131TRF	G2070676		1-	A	F5
D 1030	DIODE				MA2S111-(TX)	G2070614		1-	A	C4
D 1031	DIODE				MA2S111-(TX)	G2070614		1-	A	C5
D 1032	DIODE				MA2S72800L	G2070858		1-	A	B5
D 1033	DIODE				DAN222 TL	G2070174		1-	B	d5
D 1034	DIODE				DAN222 TL	G2070174		1-	B	d5
D 1035	DIODE				DAN222 TL	G2070174		1-	B	f4
D 1036	DIODE				DAN222 TL	G2070174		1-	A	B3
D 1037	DIODE				DAN222 TL	G2070174		1-	A	B3
D 1038	DIODE				DA221 TL	G2070178		1-	A	A4
D 1039	DIODE				DA221 TL	G2070178		1-	B	f5
D 1040	DIODE				HZM27WA-TR	G2070530		1-	B	e5
D 1041	DIODE				HZM27WA-TR	G2070530		1-	B	e5
D 1042	SURGE ABSORBER				P6KA18	Q9000721		1-	A	B1

MAIN Unit

Parts List

REF	DESCRIPTION	VALUE	V/W	TOL.	MFR'S DESIG	VXSTD P/N	VERS.	LOT	SIDE	LAY ADR
D 1043	DIODE				MA2S111-(TX)	G2070614		1-	A	A2
D 1044	DIODE				D1F20-4063	G2070474		1-	B	g3
D 1045	DIODE				MA2S111-(TX)	G2070614		1-	B	f4
D 1046	DIODE				MA2S111-(TX)	G2070614		1-	B	g4
D 1047	DIODE				MA2S111-(TX)	G2070614		1-	B	f5
D 1048	DIODE				DAP222-TL	G2070432		1-	B	b5
D 1049	DIODE				DAP222-TL	G2070432		1-	B	b5
D 1050	DIODE				MA2S111-(TX)	G2070614		1-	B	b5
D 1051	DIODE				MA2S111-(TX)	G2070614		1-	B	b5
D 1052	DIODE				DAP222-TL	G2070432		1-	B	b5
D 1053	DIODE				DAP222-TL	G2070432		1-	B	b5
D 1054	DIODE				DAP222-TL	G2070432		1-	B	b5
D 1056	DIODE				HVC365 TRF	G2070902		1-	B	e4
D 1057	DIODE				HVC365 TRF	G2070902		1-	B	e4
D 1058	DIODE				HVC350B-TRF	G2070596		1-	B	e4
D 1059	DIODE				HVC365 TRF	G2070902		1-	B	e4
D 1060	DIODE				DA221 TL	G2070178		1-	B	e4
D 1061	DIODE				UDZS TE-17 5.1B	G2070908		1-	A	C4
D 1062	DIODE				HVC365 TRF	G2070902		1-	B	d5
D 1063	DIODE				HVC365 TRF	G2070902		1-	B	d5
D 1064	DIODE				HVC365 TRF	G2070902		1-	B	d5
D 1065	DIODE				HVC365 TRF	G2070902		1-	B	c5
D 1066	DIODE				DA221 TL	G2070178		1-	B	d4
D 1067	DIODE				UDZS TE-17 5.1B	G2070908		1-	B	c5
D 1068	DIODE				DAN222 TL	G2070174		1-	A	D5
D 1069	DIODE				HVC375B-TRF	G2070856		1-	B	d4
D 1070	DIODE				HVC350B-TRF	G2070596		1-	B	d4
D 1071	DIODE				HSC277TRF	G2070584		1-	B	d4
D 1072	DIODE				HVC131TRF	G2070676		1-	A	C4
D 1073	DIODE				HSC277TRF	G2070584		1-	A	C3
D 1074	DIODE				HSC277TRF	G2070584		1-	A	D4
D 1075	DIODE				HSC277TRF	G2070584		1-	A	D3
D 1076	DIODE				HVC365 TRF	G2070902		1-	B	d4
D 1077	DIODE				HVC365 TRF	G2070902		1-	B	d4
D 1078	DIODE				HSC277TRF	G2070584		1-	B	d4
D 1079	DIODE				HSC277TRF	G2070584		1-	A	C4
D 1080	DIODE				HSC277TRF	G2070584		1-	A	C4
D 1081	DIODE				MA2S111-(TX)	G2070614		1-	B	e3
D 1082	DIODE				HVC358B(TAPE)	G2070590		1-	A	D5
D 1083	DIODE				HVC358B(TAPE)	G2070590		1-	A	D5
D 1084	DIODE				HSC277TRF	G2070584		1-	B	c5
D 1085	DIODE				HSC277TRF	G2070584		1-	A	E5
D 1086	DIODE				HVC365 TRF	G2070902		1-	A	D5
D 1087	DIODE				HVC365 TRF	G2070902		1-	A	D5
D 1088	DIODE				HSC277TRF	G2070584		1-	A	D5
D 1089	DIODE				HSC277TRF	G2070584		1-	B	c5
D 1091	DIODE				MA2S111-(TX)	G2070614		1-	A	D4
D 1092	DIODE				DAN222 TL	G2070174		1-	A	E5
D 1093	DIODE				HVC300A(TAPE)	G2070586		1-	B	c5
D 1094	DIODE				HSC277TRF	G2070584		1-	B	c5
D 1095	DIODE				HSC277TRF	G2070584		1-	A	E4
D 1096	DIODE				HSC277TRF	G2070584		1-	A	E5
D 1097	DIODE				HVC365 TRF	G2070902		1-	B	b4
D 1098	DIODE				HVC362TRF	G2070636		1-	B	b4
D 1100	DIODE				DAN222 TL	G2070174		1-	A	B3
D 1101	DIODE				UM9957F/TR	G2070562		1-	B	c1
D 1102	DIODE				UM9957F/TR	G2070562		1-	A	E2
D 1103	DIODE				MA2S72800L	G2070858		1-	B	b2
D 1104	DIODE				UM9957F/TR	G2070562		1-	A	F2
D 1105	DIODE				MA2S72800L	G2070858		1-	B	b2
D 1107	DIODE				MA2S72800L	G2070858		1-	B	a1
D 1108	DIODE				DAN222 TL	G2070174		1-	B	c3
D 1109	DIODE				MA2S111-(TX)	G2070614		1-	B	b4
D 1110	DIODE				MA2S111-(TX)	G2070614		1-	B	b4
D 1112	DIODE				HSC277TRF	G2070584		1-	B	b1
D 1113	DIODE				MA2S111-(TX)	G2070614		1-	B	a1
D 1114	DIODE				MA2S72800L	G2070858		1-	B	b1
D 1115	DIODE				MA2S72800L	G2070858		1-	B	a1
D 1116	DIODE				MA2S111-(TX)	G2070614		1-	B	b4
D 1117	DIODE				MA2S111-(TX)	G2070614		1-	B	b3
D 1118	DIODE				HSC277TRF	G2070584		1-	B	c3
D 1119	DIODE				MA2S72800L	G2070858		1-	B	b3
D 1120	DIODE				MA2S72800L	G2070858		1-	B	c3
D 1121	DIODE				MA2S72800L	G2070858		1-	B	b3
D 1122	DIODE				MA2S72800L	G2070858		1-	B	c3
D 1123	DIODE				MA2S111-(TX)	G2070614		1-	B	a4

MAIN Unit

Parts List

REF	DESCRIPTION	VALUE	V/W	TOL.	MFR'S DESIG	VXSTD P/N	VERS.	LOT	SIDE	LAY ADR
D 1125	DIODE				DAN222 TL	G2070174		1-	B	e3
D 1126	DIODE				DAN222 TL	G2070174		1-	B	e3
D 1127	DIODE				DAN235E TL	G2070612		1-	B	d3
D 1128	DIODE				DAN235E TL	G2070612		1-	B	d3
D 1129	DIODE				MA2S111-(TX)	G2070614		1-	B	e3
D 1130	DIODE				MA2S111-(TX)	G2070614		1-	B	e3
D 1132	DIODE				D1F20-4063	G2070474		1-	A	B2
D 1133	DIODE				RLS135 TE-11	G2070128		1-	A	C2
D 1134	DIODE				HSC277TRF	G2070584		1-	A	C2
D 1135	DIODE				HZM13NB2 TR	G2070894		1-	A	D3
D 1136	DIODE				MA2S111-(TX)	G2070614		1-	B	d3
D 1137	DIODE				MA2S111-(TX)	G2070614		1-	A	D3
D 1138	DIODE				HSC277TRF	G2070584		1-	A	C3
D 1139	DIODE				HSC277TRF	G2070584		1-	A	C3
D 1140	DIODE				HSC277TRF	G2070584		1-	A	C3
D 1141	DIODE				HSC277TRF	G2070584		1-	B	d3
D 1142	DIODE				HSC277TRF	G2070584		1-	B	d2
D 1144	DIODE				HSC277TRF	G2070584		1-	A	G3
D 1145	DIODE				HSC277TRF	G2070584		1-	A	G3
D 1146	DIODE				UM9957F/TR	G2070562		1-	A	E2
D 1147	DIODE				DAN222 TL	G2070174		1-	B	b5
D 1148	DIODE				HVC131TRF	G2070676		1-	A	F4
FB1001	BEADS COIL				B-01-A	L1190386		1-	A	B1
FB1002	FERRITE BEADS				SMB304729	L9190094		1-	A	C1
HS1001	HEATSINK PLATE					RA0227600		1-	B	d3
J 1001	CONNECTOR				HSJ6062-01-440	P1090983		1-	A	A1
J 1002	CONNECTOR				SC25-02WS	P0090621		1-	A	A3
J 1003	CONNECTOR				MD-S6000-90	P1091087		1-	B	f1
J 1004	CONNECTOR				B2B-ZR	P0090647		1-	A	B1
J 1005	CONNECTOR				MJ-66J-RD315K	P1091049		1-	A	B6
L 1001	COIL	0.014uH			AS050425-14NK	L0022583		1-	A	F2
L 1002	M.RFC	0.015uH		2%	C1608CA-15NG	L1691034		1-	B	b3
L 1003	M.RFC	0.01uH		2%	C1608CA-10NG	L1691032		1-	B	b3
L 1004	M.RFC	0.039uH		2%	C1608CA-39NG	L1691039		1-	B	b4
L 1005	M.RFC	0.039uH		2%	C1608CA-39NG	L1691039		1-	B	b4
L 1006	M.RFC	0.1uH			TFL0816-100N	L1690981		1-	B	b4
L 1007	M.RFC	0.01uH		2%	C1608CA-10NG	L1691032		1-	B	c4
L 1008	COIL				E2 0.28-1.0-4T-R	L0022365		1-	B	c4
L 1009	COIL				E2 0.28-1.0-4T-R	L0022365		1-	B	c4
L 1010	M.RFC	0.015uH			TFL0816-15	L1690493		1-	B	c4
L 1011	M.RFC	0.1uH			TFL0816-100N	L1690981		1-	A	F4
L 1012	M.RFC	0.01uH		2%	C1608CA-10NG	L1691032		1-	A	F4
L 1013	COIL				E2 0.28-1.0-4T-R	L0022365		1-	A	F5
L 1014	COIL				E2 0.28-1.0-4T-R	L0022365		1-	A	F5
L 1015	M.RFC	0.015uH			TFL0816-15	L1690493		1-	A	F5
L 1016	M.RFC	0.015uH			TFL0816-15	L1690493		1-	A	F4
L 1017	M.RFC	0.015uH			TFL0816-15	L1690493		1-	A	F5
L 1018	M.RFC	0.047uH		2%	C1608CA-47NG	L1691040		1-	B	b2
L 1019	M.RFC	0.1uH		2%	C1608CA-R10G	L1691045		1-	B	a3
L 1020	M.RFC	0.047uH		2%	C1608CA-47NG	L1691040		1-	B	a4
L 1021	M.RFC	0.033uH		2%	C1608CA-33NG	L1691038		1-	B	a4
L 1023	M.RFC	0.1uH		2%	C1608CA-R10G	L1691045		1-	B	a4
L 1024	M.RFC	1uH			LK1608 1R0K-T	L1690687		1-	B	b4
L 1025	M.RFC	0.082uH		2%	C1608CA-82NG	L1691044		1-	B	b4
L 1026	M.RFC	0.082uH		2%	C1608CA-82NG	L1691044		1-	B	c4
L 1027	M.RFC	0.082uH		2%	C1608CA-82NG	L1691044		1-	B	c4
L 1028	M.RFC	0.047uH			TFL0816-47	L1690499		1-	B	c4
L 1034	M.RFC	1uH			LK1608 1R0K-T	L1690687		1-	B	a4
L 1035	M.RFC	0.082uH		2%	C1608CA-82NG	L1691044		1-	B	a4
L 1036	M.RFC	0.082uH		2%	C1608CA-82NG	L1691044		1-	B	a5
L 1037	M.RFC	0.082uH		2%	C1608CA-82NG	L1691044		1-	B	a5
L 1038	M.RFC	0.047uH			TFL0816-47	L1690499		1-	B	a5
L 1039	M.RFC	0.15uH		2%	C1608CA-R15G	L1691101		1-	B	a4
L 1040	M.RFC	0.22uH		2%	C1608CA-R22G	L1691103		1-	B	a4
L 1041	M.RFC	0.22uH		2%	C1608CA-R22G	L1691103		1-	B	a4
L 1042	M.RFC	0.27uH		2%	C1608CA-R27G	L1691104		1-	A	G4
L 1043	M.RFC	0.39uH		2%	C1608CA-R39G	L1691107		1-	A	G4
L 1044	M.RFC	0.39uH		2%	C1608CA-R39G	L1691107		1-	A	G4
L 1045	M.RFC	0.39uH		2%	C1608CA-R39G	L1691107		1-	A	G4
L 1046	M.RFC	0.39uH		2%	C1608CA-R39G	L1691107		1-	A	G5
L 1047	M.RFC	0.39uH		2%	C1608CA-R39G	L1691107		1-	A	G5
L 1048	M.RFC	0.22uH		2%	C1608CA-R22G	L1691103		1-	B	a4
L 1049	M.RFC	0.22uH		2%	C1608CA-R22G	L1691103		1-	B	a5
L 1050	M.RFC	0.22uH		2%	C1608CA-R22G	L1691103		1-	B	a5
L 1051	M.RFC	0.0082uH			TFL0816-8N2	L1690490		1-	B	a3
L 1052	M.RFC	0.0082uH			TFL0816-8N2	L1690490		1-	B	a3

MAIN Unit

Parts List

REF	DESCRIPTION	VALUE	V/W	TOL.	MFR'S DESIG	VXSTD P/N	VERS.	LOT	SIDE	LAY ADR
L 1053	M.RFC	0.0047uH			TFL0816-4N7	L1690487		1-	A	G4
L 1054	M.RFC	0.0039uH			TFL0816-3N9	L1690486		1-	A	F4
L 1055	M.RFC	0.0047uH			TFL0816-4N7	L1690487		1-	A	F4
L 1056	M.RFC	0.0047uH			TFL0816-4N7	L1690487		1-	A	F5
L 1057	M.RFC	0.0047uH			TFL0816-4N7	L1690487		1-	A	F5
L 1058	M.RFC	0.39uH		2%	C1608CA-R39G	L1691107		1-	A	C4
L 1059	M.RFC	0.39uH		2%	C1608CA-R39G	L1691107		1-	A	B4
L 1060	M.RFC	0.39uH		2%	C1608CA-R39G	L1691107		1-	B	b5
L 1061	M.RFC	0.39uH		2%	C1608CA-R39G	L1691107		1-	A	C5
L 1062	M.RFC	0.39uH		2%	C1608CA-R39G	L1691107		1-	B	e3
L 1063	M.RFC	0.39uH		2%	C1608CA-R39G	L1691107		1-	A	C5
L 1064	M.RFC	150uH			FLC32T-151J	L1690229		1-	B	f4
L 1065	M.RFC	1uH			LK1608 1R0K-T	L1690687		1-	B	f5
L 1066	M.RFC	1uH			LK1608 1R0K-T	L1690687		1-	B	d4
L 1067	COIL				E2 0.3-1.1-3T-R	L0022579		1-	B	d4
L 1068	M.RFC	0.0039uH			TFL0816-3N9	L1690486		1-	B	d4
L 1069	M.RFC	0.022uH			TFL0816-22	L1690495		1-	B	d4
L 1070	M.RFC	1uH			LK1608 1R0K-T	L1690687		1-	B	d4
L 1071	CHIP COIL	0.039uH		2%	LQN21A39NG04	L1690798		1-	B	d4
L 1072	M.RFC	0.022uH		2%	C1608CA-22NG	L1691036		1-	B	d4
L 1073	M.RFC	0.22uH			LK1608 R22K-T	L1690410		1-	B	d4
L 1074	M.RFC	1uH			LK1608 1R0K-T	L1690687		1-	A	D5
L 1075	COIL				E2 0.28-1.0-4T-R	L0022365		1-	A	D5
L 1076	M.RFC	0.033uH			TFL0816-33	L1690497		1-	A	D5
L 1077	CHIP COIL	0.033uH		2%	LQN21A33NG04	L1691222		1-	A	D5
L 1078	M.RFC	0.015uH		2%	C1608CA-15NG	L1691034		1-	A	D5
L 1079	M.RFC	0.15uH			LK1608 R15K-T	L1690409		1-	A	D5
L 1081	CHIP COIL	0.18uH		2%	LQN21AR18G04	L1691223		1-	B	c4
L 1082	M.RFC	0.39uH		2%	C1608CA-R39G	L1691107		1-	B	c5
L 1083	M.RFC	2.2uH			LK1608 2R2K-T	L1690634		1-	B	c4
L 1084	CHIP COIL	0.22uH		2%	LQN21AR22G04	L1691224		1-	B	c4
L 1085	M.RFC	0.47uH			LK1608 R47K-T	L1690414		1-	B	b5
L 1086	M.RFC	0.22uH			LK1608 R22K-T	L1690410		1-	A	E5
L 1087	M.RFC	0.47uH			LK2125 R47K-T	L1690315		1-	A	D3
L 1088	COIL	0.0068uH			AS100240-6R8N	L0022656		1-	A	E2
L 1089	COIL				E2 0.25-1.9-5.5T-R	L0022610		1-	A	E2
L 1090	COIL	0.015uH			AS100440-15N	L0022811		1-	A	E2
L 1091	COIL	0.015uH			AS100440-15N	L0022811		1-	A	E2
L 1092	COIL	0.015uH			AS0803-15NK	L0022536		1-	A	F3
L 1093	COIL	0.012uH			AS080336-12N	L0022810		1-	A	F3
L 1094	COIL A1				3.5T3.5D1.0UEW R	L0022805		1-	A	F2
L 1095	COIL A1				3.5T3.5D1.0UEW R	L0022805		1-	A	F2
L 1096	M.RFC	1uH			ELJ-ND1R0JF	L1690977		1-	B	c2
L 1097	COIL				E2 0.25-1.9-5.5T-R	L0022610		1-	A	D1
L 1098	COIL A1				1.5T3.0D1.2UEW R	L0022806		1-	A	D1
L 1099	COIL A1				3.5T3.5D1.0UEW R	L0022805		1-	A	E1
L 1100	COIL A1				2.5T3.5D1.0UEW R	L0022804		1-	A	E1
L 1101	COIL A1				3.5T3.5D1.0UEW R	L0022805		1-	A	E1
L 1102	COIL A1				3.5T3.0D0.8UEW R	L0022798		1-	A	F2
L 1103	COIL A1				7.5T5.0D0.8UEW R	L0022800		1-	A	F3
L 1104	COIL A1				7.5T5.0D0.8UEW R	L0022800		1-	A	F3
L 1105	COIL A1				2.5T5.0D1.2UEW R	L0022809		1-	A	D2
L 1106	COIL A1				2.5T3.0D1.2UEW R	L0022807		1-	A	E2
L 1107	COIL A1				7.5T6.0D0.8UEW R	L0022808		1-	A	D3
L 1108	COIL A1				8.5T6.0D0.8UEW R	L0022802		1-	A	E3
L 1109	COIL A1				7.5T5.0D0.8UEW R	L0022800		1-	A	E3
L 1110	M.RFC	1uH			LK1608 1R0K-T	L1690687		1-	B	e3
L 1118	COIL A1				13.5T5.5D0.8UEW R	L0022801		1-	A	D1
L 1120	COIL	0.044uH			AS050535-44N	L0022812		1-	A	B1
L 1121	COIL	0.012uH			AS080336-12N	L0022810		1-	A	C1
L 1123	COIL				E2 0.4-3.0-11.5T-L	L0022646		1-	A	B3
L 1124	COIL				E2 0.4-3.0-11.5T-L	L0022646		1-	A	C3
L 1125	COIL	0.056uH			AS050635-56N	L0022813		1-	A	B3
L 1127	M.RFC	1uH			ELJ-ND1R0JF	L1690977		1-	B	e2
L 1128	COIL				E2 0.35-1.6-7T-L	L0022390		1-	A	B2
L 1129	COIL				E2 0.35-1.6-5.5T-L	L0022616		1-	A	C2
L 1130	M.RFC	1uH			ELJ-ND1R0JF	L1690977		1-	B	e2
L 1131	COIL				E2 0.45-1.4-2.5T-L	L0022618		1-	A	C2
L 1132	COIL				E2 0.4-1.3-2T-L	L0022580		1-	A	C2
L 1134	M.RFC	0.1uH		2%	C1608CA-R10G	L1691045		1-	A	D3
L 1135	M.RFC	0.27uH		2%	C1608CA-R27G	L1691104		1-	B	d3
L 1136	M.RFC	0.15uH		2%	C1608CA-R15G	L1691101		1-	B	d3
L 1137	M.RFC	0.022uH			TFL0816-22	L1690495		1-	B	d3
L 1138	M.RFC	0.015uH			TFL0816-15	L1690493		1-	B	d3
L 1139	M.RFC	0.0082uH			TFL0816-8N2	L1690490		1-	A	C3
L 1140	COIL				E2 0.35-1.6-4.5T-L	L0022577		1-	A	C3

MAIN Unit

Parts List

REF	DESCRIPTION	VALUE	V/W	TOL.	MFR'S DESIG	VXSTD P/N	VERS.	LOT	SIDE	LAY ADR
L 1141	COIL				E2 0.3-1.1-3T-R	L0022579		1-	A	C3
L 1142	COIL				E2 0.4-1.3-2T-L	L0022580		1-	A	C3
L 1143	COIL				E2 0.28-1.0-8TR	L0022423		1-	A	C3
L 1144	M.RFC	0.1uH		2%	C1608CA-R10G	L1691045		1-	B	d3
L 1145	M.RFC	0.1uH		2%	C1608CA-R10G	L1691045		1-	B	d3
L 1146	M.RFC	0.22uH		2%	C1608CA-R22G	L1691103		1-	B	d3
L 1147	M.RFC	0.22uH		2%	C1608CA-R22G	L1691103		1-	B	d3
L 1148	M.RFC	0.1uH		2%	C1608CA-R10G	L1691045		1-	A	B3
L 1149	COIL				E2 0.25-1.9-5.5T-R	L0022610		1-	A	E1
L 1150	CHIP COIL	0.033uH		2%	LQN21A33NG04	L1691222		1-	B	b2
L 1151	M.RFC	1uH			ELJ-ND1R0JF	L1690977		1-	A	B2
L 1152	M.RFC	1uH			LK1608 1R0K-T	L1690687		1-	B	b5
L 1153	M.RFC	4.7uH			LK1608 4R7K-T	L1690688		1-	B	c4
L 1154	M.RFC	1uH			LK1608 1R0K-T	L1690687		1-	A	D5
L 1156	M.RFC	0.022uH			TFL0816-22	L1690495		1-	A	D4
L 1158	M.RFC	1uH			ELJ-ND1R0JF	L1690977		1-		
Q 1001	FET				3SK296ZQ-TL	G4802968		1-	B	b4
Q 1002	FET				3SK296ZQ-TL	G4802968		1-	B	b4
Q 1003	FET				3SK296ZQ-TL	G4802968		1-	B	c4
Q 1004	FET				3SK296ZQ-TL	G4802968		1-	A	F5
Q 1005	TRANSISTOR				2SC5006-T1	G3350068		1-	A	F5
Q 1006	FET				3SK296ZQ-TL	G4802968		1-	B	a4
Q 1007	FET				3SK296ZQ-TL	G4802968		1-	B	a4
Q 1008	FET				3SK296ZQ-TL	G4802968		1-	B	c4
Q 1010	FET				3SK296ZQ-TL	G4802968		1-	B	a5
Q 1011	TRANSISTOR				2SC5374-TL	G3353748		1-	B	a4
Q 1012	TRANSISTOR				2SC5374-TL	G3353748		1-	A	G4
Q 1013	TRANSISTOR				2SC5277-D2-TL	G3352778B		1-	A	F4
Q 1014	TRANSISTOR				2SC5006-T1	G3350068		1-	A	F5
Q 1015	FET				3SK296ZQ-TL	G4802968		1-	B	a5
Q 1016	TRANSISTOR				RT1N441U-T11-1	G3070247		1-	A	E4
Q 1017	TRANSISTOR				2SC4400-3-TL	G3344008C		1-	A	C4
Q 1018	IC				TA31136FN(EL)	G1091605		1-	A	B4
Q 1019	TRANSISTOR				2SC4400-3-TL	G3344008C		1-	B	b5
Q 1020	TRANSISTOR				RT1N441U-T11-1	G3070247		1-	A	E4
Q 1021	TRANSISTOR				2SC4617 TL R	G3346178R		1-	B	e5
Q 1022	TRANSISTOR				2SC4617 TL R	G3346178R		1-	A	C4
Q 1023	TRANSISTOR				2SC4617 TL R	G3346178R		1-	B	e5
Q 1024	IC				TA31136FN(EL)	G1091605		1-	A	C5
Q 1025	IC				NJM2902V-TE1	G1091679		1-	B	f4
Q 1026	TRANSISTOR				2SC4400-3-TL	G3344008C		1-	B	e4
Q 1027	TRANSISTOR				2SC4400-3-TL	G3344008C		1-	B	d5
Q 1028	TRANSISTOR				RT1N441U-T11-1	G3070247		1-	B	d5
Q 1030	TRANSISTOR				RT1N441U-T11-1	G3070247		1-	A	A4
Q 1031	TRANSISTOR				RT1N441U-T11-1	G3070247		1-	A	A4
Q 1032	TRANSISTOR				RT1N441U-T11-1	G3070247		1-	B	f4
Q 1033	IC				NJM2902V-TE1	G1091679		1-	A	A4
Q 1034	IC				NJM2902V-TE1	G1091679		1-	B	f4
Q 1035	TRANSISTOR				RT1N441U-T11-1	G3070247		1-	A	B3
Q 1036	TRANSISTOR				2SC4617 TL R	G3346178R		1-	A	B3
Q 1037	TRANSISTOR				2SC4617 TL R	G3346178R		1-	A	A3
Q 1038	TRANSISTOR				RT1N441U-T11-1	G3070247		1-	A	A4
Q 1039	TRANSISTOR				RT1N441U-T11-1	G3070247		1-	A	A4
Q 1040	TRANSISTOR				RT1N441U-T11-1	G3070247		1-	B	g4
Q 1041	TRANSISTOR				RT1N441U-T11-1	G3070247		1-	B	g4
Q 1042	IC				M51132FP 600C	G1091930		1-	A	A2
Q 1043	TRANSISTOR				CPH6102-TL	G3070223		1-	B	f1
Q 1044	TRANSISTOR				RT1N441U-T11-1	G3070247		1-	B	f1
Q 1045	IC				LA4425A	G1092241		1-	A	A2
Q 1046	IC				TC4W66FU TE12L	G1091676		1-	B	f3
Q 1047	IC				TC4W66FU TE12L	G1091676		1-	B	f2
Q 1050	IC				TDA7233D-TR	G1091112		1-	A	A3
Q 1051	IC				BU4066BCFV-E2	G1093537		1-	A	B4
Q 1052	TRANSISTOR				RT1N441U-T11-1	G3070247		1-	A	A1
Q 1053	TRANSISTOR				RT1N441U-T11-1	G3070247		1-	A	A1
Q 1054	IC				NJM2902V-TE1	G1091679		1-	A	A4
Q 1055	TRANSISTOR				2SC4617 TL R	G3346178R		1-	B	e1
Q 1056	TRANSISTOR				RT1N441U-T11-1	G3070247		1-	B	e5
Q 1057	TRANSISTOR				2SB1301-T2 ZQ	G3213017Q		1-	A	B2
Q 1058	TRANSISTOR				2SB1201S-TL	G3070195		1-	B	e2
Q 1059	IC				MM1216ENRE	G1092432		1-	B	e2
Q 1060	IC				NJM78L05UA TE1	G1091325		1-	A	B2
Q 1061	TRANSISTOR				2SC4617 TL R	G3346178R		1-	A	A2
Q 1062	TRANSISTOR				2SA1774 TL R	G3117748R		1-	B	f3
Q 1063	IC				NJM78L05UA TE1	G1091325		1-	B	g3
Q 1064	IC				M51951BHP-600C	G1093634		1-	B	f4

MAIN Unit

Parts List

REF	DESCRIPTION	VALUE	V/W	TOL.	MFR'S DESIG	VXSTD P/N	VERS.	LOT	SIDE	LAY ADR
Q 1065	TRANSISTOR				2SC4617 TL R	G3346178R		1-	B	g4
Q 1066	TRANSISTOR				2SC4617 TL R	G3346178R		1-	B	f5
Q 1067	IC				AT24C128N-10SI-2.7	G1093516		1-	B	g5
Q 1068	TRANSISTOR				RT1N441U-T11-1	G3070247		1-	B	f3
Q 1069	TRANSISTOR				RT1N441U-T11-1	G3070247		1-	B	a5
Q 1070	TRANSISTOR				RT1N441U-T11-1	G3070247		1-	B	a5
Q 1071	TRANSISTOR				UMA8N TR	G3070270		1-	A	E5
Q 1072	TRANSISTOR				UMA8N TR	G3070270		1-	A	F5
Q 1073	TRANSISTOR				UMA8N TR	G3070270		1-	A	F5
Q 1074	TRANSISTOR				UMA8N TR	G3070270		1-	A	F5
Q 1075	IC				BU2090FS-E1	G1092187		1-	A	E5
Q 1076	TRANSISTOR				IMT17 T110	G3070295		1-	A	E4
Q 1077	TRANSISTOR				IMT17 T110	G3070295		1-	A	E4
Q 1078	TRANSISTOR				2SC4617 TL R	G3346178R		1-	B	b5
Q 1079	TRANSISTOR				RT1P441U-T11-1	G3070248		1-	A	E5
Q 1080	TRANSISTOR				UMA8N TR	G3070270		1-	B	b5
Q 1081	TRANSISTOR				UMA8N TR	G3070270		1-	B	b5
Q 1082	TRANSISTOR				UMA8N TR	G3070270		1-	B	b5
Q 1083	TRANSISTOR				RT1P441U-T11-1	G3070248		1-	A	E5
Q 1084	IC				M3826AEFGP R0704	G1093798	DST: USA	1-	A	A5
Q 1084	IC				M3826AEFGP R0705	G1093799	DST: EXP	1-	A	A5
Q 1085	IC				M62353GP 70ED	G1092621		1-	B	f5
Q 1086	IC				BU4066BCFV-E2	G1093537		1-	B	e4
Q 1087	TRANSISTOR				RT1N441U-T11-1	G3070247		1-	B	e4
Q 1088	TRANSISTOR				RT1N441U-T11-1	G3070247		1-	B	e3
Q 1089	TRANSISTOR				2SA1774 TL R	G3117748R		1-	A	C3
Q 1090	IC				MB15A02PFV1-G-BND-EF	G1092541		1-	A	C4
Q 1091	TRANSISTOR				2SA1774 TL R	G3117748R		1-	A	B4
Q 1092	TRANSISTOR				2SC4617 TL R	G3346178R		1-	A	C4
Q 1094	TRANSISTOR				2SA1774 TL R	G3117748R		1-	B	c5
Q 1095	IC				MB15A02PFV1-G-BND-EF	G1092541		1-	B	c5
Q 1096	TRANSISTOR				RT1P441U-T11-1	G3070248		1-	B	d5
Q 1097	TRANSISTOR				2SC4617 TL R	G3346178R		1-	B	d5
Q 1098	TRANSISTOR				2SA1774 TL R	G3117748R		1-	B	c5
Q 1099	TRANSISTOR				2SC4617 TL R	G3346178R		1-	B	c5
Q 1100	TRANSISTOR				RT1N441U-T11-1	G3070247		1-	B	c5
Q 1106	TRANSISTOR				2SC5006-T1	G3350068		1-	B	d4
Q 1107	TRANSISTOR				2SC5006-T1	G3350068		1-	B	d4
Q 1108	TRANSISTOR				2SC5006-T1	G3350068		1-	A	C4
Q 1109	TRANSISTOR				2SC5374-TL	G3353748		1-	B	d4
Q 1110	TRANSISTOR				2SC5374-TL	G3353748		1-	B	d4
Q 1111	TRANSISTOR				2SC5374-TL	G3353748		1-	A	D4
Q 1112	TRANSISTOR				2SC5006-T1	G3350068		1-	A	D5
Q 1113	TRANSISTOR				2SC5006-T1	G3350068		1-	A	D5
Q 1114	TRANSISTOR				2SC5374-TL	G3353748		1-	A	E5
Q 1115	TRANSISTOR				2SC5374-TL	G3353748		1-	A	D5
Q 1116	TRANSISTOR				2SC5374-TL	G3353748		1-	A	D5
Q 1117	TRANSISTOR				2SC5374-TL	G3353748		1-	A	E5
Q 1118	TRANSISTOR				2SC5374-TL	G3353748		1-	B	c4
Q 1119	TRANSISTOR				2SC5374-TL	G3353748		1-	B	c4
Q 1120	TRANSISTOR				RT1N441U-T11-1	G3070247		1-	B	c5
Q 1121	TRANSISTOR				2SC5374-TL	G3353748		1-	B	c4
Q 1122	TRANSISTOR				2SC5374-TL	G3353748		1-	B	b5
Q 1123	TRANSISTOR				2SC5374-TL	G3353748		1-	A	D4
Q 1124	TRANSISTOR				2SC5374-TL	G3353748		1-	A	E5
Q 1125	TRANSISTOR				RT1N441U-T11-1	G3070247		1-	B	b4
Q 1126	TRANSISTOR				RT1N441U-T11-1	G3070247		1-	B	b4
Q 1127	TRANSISTOR				RT1N441U-T11-1	G3070247		1-	B	b4
Q 1128	TRANSISTOR				RT1N441U-T11-1	G3070247		1-	B	e3
Q 1129	TRANSISTOR				RT1P441U-T11-1	G3070248		1-	B	e3
Q 1130	IC				NJM2904V-TE1	G1091677		1-	B	e3
Q 1131	TRANSISTOR				RT1N441U-T11-1	G3070247		1-	B	e3
Q 1134	FET				RD70HVF1	G3090140		1-	A	D1
Q 1135	TRANSISTOR				2SC4617 TL R	G3346178R		1-	B	e2
Q 1137	FET				2SK2975-T11	G3829757		1-	A	C3
Q 1138	TRANSISTOR				2SD1664 T100 Q	G3416647Q		1-	A	D3
Q 1139	FET				2SK2596BXTL	G3825967		1-	A	C3
Q 1140	TRANSISTOR				RT1N441U-T11-1	G3070247		1-	B	d3
Q 1141	TRANSISTOR				RT1N441U-T11-1	G3070247		1-	A	E4
Q 1142	TRANSISTOR				2SC4617 TL R	G3346178R		1-	B	e5
Q 1143	TRANSISTOR				2SC4617 TL R	G3346178R		1-	B	d5
Q 1144	TRANSISTOR				RT1N441U-T11-1	G3070247		1-	A	B4
Q 1145	TRANSISTOR				2SC4617 TL R	G3346178R		1-	B	d5
Q 1146	TRANSISTOR				2SC5006-T1	G3350068		1-	A	C4
Q 1147	TRANSISTOR				2SC4617 TL R	G3346178R		1-	A	E5
R 1001	CHIP RES.	82k	1/16W	0.5%	RR0510R-823-D	J24189165		1-	B	b4

MAIN Unit

Parts List

REF	DESCRIPTION	VALUE	V/W	TOL.	MFR'S DESIG	VXSTD P/N	VERS.	LOT	SIDE	LAY ADR
R 1002	CHIP RES.	100k	1/16W	5%	RMC1/16S 104JTH	J24189049		1-	B	b4
R 1003	CHIP RES.	47k	1/16W	0.5%	RR0510R-473-D	J24189159		1-	B	b3
R 1004	CHIP RES.	100	1/16W	5%	RMC1/16S 101JTH	J24189013		1-	B	b4
R 1005	CHIP RES.	0	1/16W	5%	RMC1/16S JPTH	J24189070		1-	A	F4
R 1006	CHIP RES.	100k	1/16W	5%	RMC1/16S 104JTH	J24189049		1-	B	b4
R 1007	CHIP RES.	100	1/16W	5%	RMC1/16S 101JTH	J24189013		1-	B	b4
R 1008	CHIP RES.	22	1/16W	5%	RMC1/16S 220JTH	J24189005		1-	B	b4
R 1009	CHIP RES.	2.2k	1/16W	5%	RMC1/16S 222JTH	J24189029		1-	B	b4
R 1010	CHIP RES.	100	1/16W	5%	RMC1/16S 101JTH	J24189013		1-	B	b4
R 1011	CHIP RES.	100k	1/16W	5%	RMC1/16S 104JTH	J24189049		1-	B	c4
R 1012	CHIP RES.	100k	1/16W	5%	RMC1/16S 104JTH	J24189049		1-	B	c4
R 1013	CHIP RES.	100k	1/16W	5%	RMC1/16S 104JTH	J24189049		1-	B	c4
R 1014	CHIP RES.	220k	1/16W	5%	RMC1/16S 224JTH	J24189053		1-	B	c4
R 1015	CHIP RES.	33k	1/16W	5%	RMC1/16S 333JTH	J24189043		1-	B	c4
R 1016	CHIP RES.	150	1/16W	5%	RMC1/16S 151JTH	J24189015		1-	B	c4
R 1017	CHIP RES.	220k	1/16W	5%	RMC1/16S 224JTH	J24189053		1-	B	c4
R 1018	CHIP RES.	47k	1/16W	5%	RMC1/16S 473JTH	J24189045		1-	B	c4
R 1019	CHIP RES.	1k	1/16W	5%	RMC1/16S 102JTH	J24189025		1-	B	c3
R 1020	CHIP RES.	2.2k	1/16W	5%	RMC1/16S 222JTH	J24189029		1-	A	F4
R 1021	CHIP RES.	100	1/16W	5%	RMC1/16S 101JTH	J24189013		1-	A	F4
R 1022	CHIP RES.	100k	1/16W	5%	RMC1/16S 104JTH	J24189049		1-	A	F4
R 1023	CHIP RES.	100k	1/16W	5%	RMC1/16S 104JTH	J24189049		1-	A	F5
R 1024	CHIP RES.	100k	1/16W	5%	RMC1/16S 104JTH	J24189049		1-	A	F5
R 1025	CHIP RES.	33k	1/16W	5%	RMC1/16S 333JTH	J24189043		1-	A	F5
R 1026	CHIP RES.	220k	1/16W	5%	RMC1/16S 224JTH	J24189053		1-	A	F5
R 1027	CHIP RES.	150	1/16W	5%	RMC1/16S 151JTH	J24189015		1-	A	F5
R 1028	CHIP RES.	1k	1/16W	5%	RMC1/16S 102JTH	J24189025		1-	A	F5
R 1029	CHIP RES.	220k	1/16W	5%	RMC1/16S 224JTH	J24189053		1-	A	F5
R 1030	CHIP RES.	47k	1/16W	5%	RMC1/16S 473JTH	J24189045		1-	A	F5
R 1031	CHIP RES.	100	1/16W	5%	RMC1/16S 101JTH	J24189013		1-	A	F4
R 1032	CHIP RES.	47k	1/16W	5%	RMC1/16S 473JTH	J24189045		1-	A	F5
R 1033	CHIP RES.	4.7k	1/16W	5%	RMC1/16S 472JTH	J24189033		1-	A	F4
R 1034	CHIP RES.	0	1/16W	5%	RMC1/16S JPTH	J24189070		1-	A	F4
R 1035	CHIP RES.	1M	1/16W	5%	RMC1/16S 105JTH	J24189061		1-	A	F5
R 1036	CHIP RES.	1k	1/16W	5%	RMC1/16S 102JTH	J24189025		1-	A	F5
R 1037	CHIP RES.	56k	1/16W	0.5%	RR0510R-563-D	J24189161		1-	B	a4
R 1038	CHIP RES.	47k	1/16W	0.5%	RR0510R-473-D	J24189159		1-	B	a4
R 1039	CHIP RES.	100k	1/16W	5%	RMC1/16S 104JTH	J24189049		1-	B	a4
R 1040	CHIP RES.	47	1/16W	5%	RMC1/16S 470JTH	J24189009		1-	B	a4
R 1041	CHIP RES.	100k	1/16W	5%	RMC1/16S 104JTH	J24189049		1-	B	b4
R 1042	CHIP RES.	47	1/16W	5%	RMC1/16S 470JTH	J24189009		1-	B	b4
R 1043	CHIP RES.	47	1/16W	5%	RMC1/16S 470JTH	J24189009		1-	B	b4
R 1044	CHIP RES.	330	1/16W	5%	RMC1/16S 331JTH	J24189019		1-	B	b4
R 1045	CHIP RES.	100	1/16W	5%	RMC1/16S 101JTH	J24189013		1-	B	b4
R 1046	CHIP RES.	220k	1/16W	5%	RMC1/16S 224JTH	J24189053		1-	B	c4
R 1047	CHIP RES.	220k	1/16W	5%	RMC1/16S 224JTH	J24189053		1-	B	c4
R 1048	CHIP RES.	220k	1/16W	5%	RMC1/16S 224JTH	J24189053		1-	B	c4
R 1049	CHIP RES.	15k	1/16W	5%	RMC1/16S 153JTH	J24189039		1-	B	c4
R 1050	CHIP RES.	120k	1/16W	5%	RMC1/16S 124JTH	J24189050		1-	B	c4
R 1051	CHIP RES.	47k	1/16W	5%	RMC1/16S 473JTH	J24189045		1-	B	c4
R 1052	CHIP RES.	220k	1/16W	5%	RMC1/16S 224JTH	J24189053		1-	B	c4
R 1053	CHIP RES.	150	1/16W	5%	RMC1/16S 151JTH	J24189015		1-	B	c4
R 1054	CHIP RES.	1k	1/16W	5%	RMC1/16S 102JTH	J24189025		1-	B	c4
R 1058	CHIP RES.	47	1/16W	5%	RMC1/16S 470JTH	J24189009		1-	B	a4
R 1061	CHIP RES.	47k	1/16W	5%	RMC1/16S 473JTH	J24189045		1-	B	a5
R 1062	CHIP RES.	100	1/16W	5%	RMC1/16S 101JTH	J24189013		1-	B	a4
R 1063	CHIP RES.	330	1/16W	5%	RMC1/16S 331JTH	J24189019		1-	B	a4
R 1064	CHIP RES.	220k	1/16W	5%	RMC1/16S 224JTH	J24189053		1-	B	a5
R 1065	CHIP RES.	220k	1/16W	5%	RMC1/16S 224JTH	J24189053		1-	B	a5
R 1066	CHIP RES.	220k	1/16W	5%	RMC1/16S 224JTH	J24189053		1-	B	a5
R 1067	CHIP RES.	220k	1/16W	5%	RMC1/16S 224JTH	J24189053		1-	B	a5
R 1068	CHIP RES.	220	1/16W	5%	RMC1/16S 221JTH	J24189017		1-	B	a5
R 1069	CHIP RES.	22k	1/16W	5%	RMC1/16S 223JTH	J24189041		1-	B	a5
R 1070	CHIP RES.	220k	1/16W	5%	RMC1/16S 224JTH	J24189053		1-	B	a5
R 1071	CHIP RES.	220k	1/16W	5%	RMC1/16S 224JTH	J24189053		1-	B	a5
R 1072	CHIP RES.	1.5k	1/16W	5%	RMC1/16S 152JTH	J24189027		1-	B	a5
R 1073	CHIP RES.	33k	1/16W	5%	RMC1/16S 333JTH	J24189043		1-	B	a5
R 1074	CHIP RES.	47k	1/16W	5%	RMC1/16S 473JTH	J24189045		1-	B	a5
R 1075	CHIP RES.	150	1/16W	5%	RMC1/16S 151JTH	J24189015		1-	B	a5
R 1077	CHIP RES.	150k	1/16W	5%	RMC1/16S 154JTH	J24189051		1-	B	a4
R 1078	CHIP RES.	100	1/16W	5%	RMC1/16S 101JTH	J24189013		1-	B	a4
R 1079	CHIP RES.	270k	1/16W	5%	RMC1/16S 274JTH	J24189054		1-	A	G4
R 1080	CHIP RES.	100	1/16W	5%	RMC1/16S 101JTH	J24189013		1-	A	G4
R 1081	CHIP RES.	22	1/16W	5%	RMC1/16S 220JTH	J24189005		1-	A	G4
R 1082	CHIP RES.	1k	1/16W	5%	RMC1/16S 102JTH	J24189025		1-	A	G4
R 1083	CHIP RES.	100	1/16W	5%	RMC1/16S 101JTH	J24189013		1-	A	G4

MAIN Unit

Parts List

REF	DESCRIPTION	VALUE	V/W	TOL.	MFR'S DESIG	VXSTD P/N	VERS.	LOT	SIDE	LAY ADR
R 1084	CHIP RES.	47k	1/16W	5%	RMC1/16S 473JTH	J24189045		1-	A	G5
R 1085	CHIP RES.	0	1/16W	5%	RMC1/16S JPTH	J24189070		1-	B	a4
R 1086	CHIP RES.	220	1/16W	5%	RMC1/16S 221JTH	J24189017		1-	A	G5
R 1087	CHIP RES.	330	1/16W	5%	RMC1/16S 331JTH	J24189019		1-	B	a4
R 1088	CHIP RES.	100	1/16W	5%	RMC1/16S 101JTH	J24189013		1-	B	a4
R 1089	CHIP RES.	47k	1/16W	5%	RMC1/16S 473JTH	J24189045		1-	B	a4
R 1090	CHIP RES.	220	1/16W	5%	RMC1/16S 221JTH	J24189017		1-	B	a5
R 1091	CHIP RES.	22k	1/16W	5%	RMC1/16S 223JTH	J24189041		1-	A	G5
R 1092	CHIP RES.	47k	1/16W	5%	RMC1/16S 473JTH	J24189045		1-	B	a5
R 1093	CHIP RES.	220k	1/16W	5%	RMC1/16S 224JTH	J24189053		1-	B	a5
R 1094	CHIP RES.	220k	1/16W	5%	RMC1/16S 224JTH	J24189053		1-	B	a5
R 1095	CHIP RES.	68k	1/16W	5%	RMC1/16S 683JTH	J24189047		1-	B	a5
R 1096	CHIP RES.	220	1/16W	5%	RMC1/16S 221JTH	J24189017		1-	B	a5
R 1097	CHIP RES.	470k	1/16W	5%	RMC1/16S 474JTH	J24189057		1-	A	F4
R 1098	CHIP RES.	82	1/16W	5%	RMC1/16S 820JTH	J24189012		1-	A	F4
R 1099	CHIP RES.	2.2k	1/16W	5%	RMC1/16S 222JTH	J24189029		1-	A	F5
R 1100	CHIP RES.	820k	1/16W	5%	RMC1/16S 824JTH	J24189060		1-	A	F5
R 1111	CHIP RES.	6.8k	1/16W	5%	RMC1/16S 682JTH	J24189035		1-	A	F5
R 1112	CHIP RES.	47k	1/16W	5%	RMC1/16S 473JTH	J24189045		1-	A	F5
R 1113	CHIP RES.	47k	1/16W	5%	RMC1/16S 473JTH	J24189045		1-	B	a4
R 1114	CHIP RES.	82k	1/16W	0.5%	RR0510R-823-D	J24189165		1-	A	E4
R 1115	CHIP RES.	100k	1/16W	0.5%	RR0510R-104-D	J24189167		1-	B	a4
R 1116	CHIP RES.	68k	1/16W	0.5%	RR0510R-683-D	J24189163		1-	B	b4
R 1117	CHIP RES.	68k	1/16W	0.5%	RR0510R-683-D	J24189163		1-	B	b4
R 1118	CHIP RES.	33k	1/16W	0.5%	RR0510R-333-D	J24189155		1-	A	E4
R 1119	CHIP RES.	100	1/16W	5%	RMC1/16S 101JTH	J24189013		1-	A	C4
R 1120	CHIP RES.	2.2k	1/16W	5%	RMC1/16S 222JTH	J24189029		1-	A	C4
R 1121	CHIP RES.	220	1/16W	5%	RMC1/16S 221JTH	J24189017		1-	A	C4
R 1122	CHIP RES.	560	1/16W	5%	RMC1/16S 561JTH	J24189022		1-	A	C4
R 1123	CHIP RES.	220k	1/16W	5%	RMC1/16S 224JTH	J24189053		1-	A	C4
R 1124	CHIP RES.	330	1/16W	5%	RMC1/16S 331JTH	J24189019		1-	A	C4
R 1125	CHIP RES.	2.2k	1/16W	5%	RMC1/16S 222JTH	J24189029		1-	A	B4
R 1126	CHIP RES.	100	1/16W	5%	RMC1/16S 101JTH	J24189013		1-	A	B4
R 1127	CHIP RES.	47	1/16W	5%	RMC1/16S 470JTH	J24189009		1-	B	e3
R 1128	CHIP RES.	2.2k	1/16W	5%	RMC1/16S 222JTH	J24189029		1-	B	a5
R 1129	CHIP RES.	100	1/16W	5%	RMC1/16S 101JTH	J24189013		1-	B	a5
R 1130	CHIP RES.	100	1/16W	5%	RMC1/16S 101JTH	J24189013		1-	B	b5
R 1131	CHIP RES.	560	1/16W	5%	RMC1/16S 561JTH	J24189022		1-	B	b5
R 1132	CHIP RES.	330k	1/16W	5%	RMC1/16S 334JTH	J24189055		1-	B	b5
R 1133	CHIP RES.	100	1/16W	5%	RMC1/16S 101JTH	J24189013		1-	A	C5
R 1134	CHIP RES.	1k	1/16W	5%	RMC1/16S 102JTH	J24189025		1-	A	C5
R 1135	CHIP RES.	330	1/16W	5%	RMC1/16S 331JTH	J24189019		1-	B	b5
R 1136	CHIP RES.	12k	1/16W	0.5%	RR0510R-123-D	J24189145		1-	A	F4
R 1137	CHIP RES.	39k	1/16W	0.5%	RR0510R-393-D	J24189157		1-	B	b5
R 1138	CHIP RES.	10k	1/16W	0.5%	RR0510P-103-D	J24189143		1-	B	a5
R 1139	CHIP RES.	150k	1/16W	5%	RMC1/16S 154JTH	J24189051		1-	A	B5
R 1140	CHIP RES.	100k	1/16W	5%	RMC1/16S 104JTH	J24189049		1-	B	e5
R 1141	CHIP RES.	22k	1/16W	5%	RMC1/16S 223JTH	J24189041		1-	B	e5
R 1142	CHIP RES.	390k	1/16W	5%	RMC1/16S 394JTH	J24189056		1-	B	e5
R 1143	CHIP RES.	330k	1/16W	5%	RMC1/16S 334JTH	J24189055		1-	A	B5
R 1144	CHIP RES.	47k	1/16W	5%	RMC1/16S 473JTH	J24189045		1-	A	B4
R 1145	CHIP RES.	4.7k	1/16W	5%	RMC1/16S 472JTH	J24189033		1-	A	B5
R 1146	CHIP RES.	1M	1/16W	5%	RMC1/16S 105JTH	J24189061		1-	A	C5
R 1147	CHIP RES.	470	1/16W	5%	RMC1/16S 471JTH	J24189021		1-	A	C5
R 1148	CHIP RES.	4.7k	1/16W	5%	RMC1/16S 472JTH	J24189033		1-	A	C5
R 1149	CHIP RES.	1M	1/16W	5%	RMC1/16S 105JTH	J24189061		1-	B	e5
R 1150	CHIP RES.	470	1/16W	5%	RMC1/16S 471JTH	J24189021		1-	B	d5
R 1151	CHIP RES.	100k	1/16W	5%	RMC1/16S 104JTH	J24189049		1-	B	e5
R 1152	CHIP RES.	10k	1/16W	5%	RMC1/16S 103JTH	J24189037		1-	B	e4
R 1153	CHIP RES.	68k	1/16W	0.5%	RR0510R-683-D	J24189163		1-	B	f4
R 1154	CHIP RES.	100k	1/16W	0.5%	RR0510R-104-D	J24189167		1-	B	f4
R 1155	CHIP RES.	10k	1/16W	5%	RMC1/16S 103JTH	J24189037		1-	B	f4
R 1156	CHIP RES.	100k	1/16W	5%	RMC1/16S 104JTH	J24189049		1-	B	f4
R 1157	CHIP RES.	10k	1/16W	5%	RMC1/16S 103JTH	J24189037		1-	B	e4
R 1158	CHIP RES.	68k	1/16W	0.5%	RR0510R-683-D	J24189163		1-	B	f4
R 1159	CHIP RES.	47	1/16W	5%	RMC1/16S 470JTH	J24189009		1-	B	f4
R 1160	CHIP RES.	100k	1/16W	0.5%	RR0510R-104-D	J24189167		1-	B	f4
R 1161	CHIP RES.	10k	1/16W	5%	RMC1/16S 103JTH	J24189037		1-	B	f4
R 1162	CHIP RES.	100k	1/16W	5%	RMC1/16S 104JTH	J24189049		1-	B	f4
R 1163	CHIP RES.	1k	1/16W	5%	RMC1/16S 102JTH	J24189025		1-	B	e3
R 1164	CHIP RES.	1M	1/16W	5%	RMC1/16S 105JTH	J24189061		1-	B	e4
R 1165	CHIP RES.	1k	1/16W	5%	RMC1/16S 102JTH	J24189025		1-	A	C5
R 1166	CHIP RES.	1M	1/16W	5%	RMC1/16S 105JTH	J24189061		1-	B	d5
R 1167	CHIP RES.	1.5k	1/16W	0.5%	RR0510P-152-D	J24189123		1-	B	f4
R 1168	CHIP RES.	100k	1/16W	5%	RMC1/16S 104JTH	J24189049		1-	A	B4
R 1169	CHIP RES.	1k	1/16W	5%	RMC1/16S 102JTH	J24189025		1-	A	B4

MAIN Unit

Parts List

REF	DESCRIPTION	VALUE	V/W	TOL.	MFR'S DESIG	VXSTD P/N	VERS.	LOT	SIDE	LAY ADR
R 1170	CHIP RES.	100k	1/16W	5%	RMC1/16S 104JTH	J24189049		1-	A	B4
R 1171	CHIP RES.	56k	1/16W	0.5%	RR0510R-563-D	J24189161		1-	B	e4
R 1172	CHIP RES.	2.7k	1/16W	0.5%	RR0510P-272-D	J24189129		1-	B	e4
R 1173	CHIP RES.	3.3k	1/16W	0.5%	RR0510P-332-D	J24189131		1-	B	e4
R 1174	CHIP RES.	150k	1/16W	5%	RMC1/16S 154JTH	J24189051		1-	B	e4
R 1176	CHIP RES.	220	1/16W	5%	RMC1/16S 221JTH	J24189017		1-	A	B4
R 1177	CHIP RES.	47	1/16W	5%	RMC1/16S 470JTH	J24189009		1-	B	d5
R 1178	CHIP RES.	10	1/16W	5%	RMC1/16S 100JTH	J24189001		1-	A	C5
R 1179	CHIP RES.	2.7k	1/16W	0.5%	RR0510P-272-D	J24189129		1-	B	e5
R 1180	CHIP RES.	100k	1/16W	5%	RMC1/16S 104JTH	J24189049		1-	A	C5
R 1181	CHIP RES.	1k	1/16W	5%	RMC1/16S 102JTH	J24189025		1-	A	C5
R 1182	CHIP RES.	100k	1/16W	5%	RMC1/16S 104JTH	J24189049		1-	A	B5
R 1183	CHIP RES.	56k	1/16W	0.5%	RR0510R-563-D	J24189161		1-	B	d5
R 1184	CHIP RES.	2.7k	1/16W	0.5%	RR0510P-272-D	J24189129		1-	B	d5
R 1185	CHIP RES.	68k	1/16W	5%	RMC1/16S 683JTH	J24189047		1-	B	f4
R 1186	CHIP RES.	3.3k	1/16W	0.5%	RR0510P-332-D	J24189131		1-	B	d5
R 1187	CHIP RES.	150k	1/16W	5%	RMC1/16S 154JTH	J24189051		1-	B	d5
R 1189	CHIP RES.	4.7k	1/16W	5%	RMC1/16S 472JTH	J24189033		1-	B	d5
R 1190	CHIP RES.	220	1/16W	5%	RMC1/16S 221JTH	J24189017		1-	A	C5
R 1191	CHIP RES.	22k	1/16W	5%	RMC1/16S 223JTH	J24189041		1-	B	d5
R 1192	CHIP RES.	22k	1/16W	5%	RMC1/16S 223JTH	J24189041		1-	B	d5
R 1193	CHIP RES.	22k	1/16W	5%	RMC1/16S 223JTH	J24189041		1-	B	d5
R 1194	CHIP RES.	22k	1/16W	5%	RMC1/16S 223JTH	J24189041		1-	B	d5
R 1195	CHIP RES.	22k	1/16W	5%	RMC1/16S 223JTH	J24189041		1-	B	d5
R 1196	CHIP RES.	1k	1/16W	5%	RMC1/16S 102JTH	J24189025		1-	B	d5
R 1197	CHIP RES.	22k	1/16W	5%	RMC1/16S 223JTH	J24189041		1-	B	d5
R 1198	CHIP RES.	68k	1/16W	5%	RMC1/16S 683JTH	J24189047		1-	B	f4
R 1203	CHIP RES.	12k	1/16W	5%	RMC1/16S 123JTH	J24189038		1-	B	f4
R 1204	CHIP RES.	470k	1/16W	5%	RMC1/16S 474JTH	J24189057		1-	B	f4
R 1205	CHIP RES.	47k	1/16W	5%	RMC1/16S 473JTH	J24189045		1-	A	A4
R 1206	CHIP RES.	68k	1/16W	0.5%	RR0510R-683-D	J24189163		1-	B	f4
R 1207	CHIP RES.	56k	1/16W	5%	RMC1/16S 563JTH	J24189046		1-	A	A4
R 1208	CHIP RES.	220k	1/16W	5%	RMC1/16S 224JTH	J24189053		1-	A	A4
R 1209	CHIP RES.	10k	1/16W	5%	RMC1/16S 103JTH	J24189037		1-	A	A4
R 1210	CHIP RES.	1k	1/16W	5%	RMC1/16S 102JTH	J24189025		1-	B	f4
R 1211	CHIP RES.	27k	1/16W	5%	RMC1/16S 273JTH	J24189042		1-	B	f4
R 1212	CHIP RES.	390k	1/16W	5%	RMC1/16S 394JTH	J24189056		1-	B	f4
R 1213	CHIP RES.	150k	1/16W	5%	RMC1/16S 154JTH	J24189051		1-	A	A4
R 1214	CHIP RES.	100k	1/16W	5%	RMC1/16S 104JTH	J24189049		1-	B	f4
R 1215	CHIP RES.	4.7k	1/16W	5%	RMC1/16S 472JTH	J24189033		1-	A	A3
R 1216	CHIP RES.	10k	1/16W	5%	RMC1/16S 103JTH	J24189037		1-	B	f4
R 1217	CHIP RES.	330k	1/16W	5%	RMC1/16S 334JTH	J24189055		1-	B	f4
R 1218	CHIP RES.	330k	1/16W	5%	RMC1/16S 334JTH	J24189055		1-	B	f4
R 1219	CHIP RES.	68k	1/16W	0.5%	RR0510R-683-D	J24189163		1-	B	f4
R 1220	CHIP RES.	220k	1/16W	5%	RMC1/16S 224JTH	J24189053		1-	B	f4
R 1221	CHIP RES.	56k	1/16W	5%	RMC1/16S 563JTH	J24189046		1-	B	f4
R 1222	CHIP RES.	10k	1/16W	5%	RMC1/16S 103JTH	J24189037		1-	B	f4
R 1223	CHIP RES.	1k	1/16W	5%	RMC1/16S 102JTH	J24189025		1-	B	f4
R 1224	CHIP RES.	27k	1/16W	5%	RMC1/16S 273JTH	J24189042		1-	B	f4
R 1225	CHIP RES.	390k	1/16W	5%	RMC1/16S 394JTH	J24189056		1-	B	f4
R 1226	CHIP RES.	4.7k	1/16W	5%	RMC1/16S 472JTH	J24189033		1-	A	A3
R 1227	CHIP RES.	150k	1/16W	5%	RMC1/16S 154JTH	J24189051		1-	B	f4
R 1228	CHIP RES.	100k	1/16W	5%	RMC1/16S 104JTH	J24189049		1-	B	f4
R 1229	CHIP RES.	10k	1/16W	5%	RMC1/16S 103JTH	J24189037		1-	A	B3
R 1230	CHIP RES.	10k	1/16W	5%	RMC1/16S 103JTH	J24189037		1-	A	B3
R 1231	CHIP RES.	220k	1/16W	5%	RMC1/16S 224JTH	J24189053		1-	A	B3
R 1232	CHIP RES.	220k	1/16W	5%	RMC1/16S 224JTH	J24189053		1-	A	B3
R 1233	CHIP RES.	220k	1/16W	5%	RMC1/16S 224JTH	J24189053		1-	A	B3
R 1234	CHIP RES.	4.7k	1/16W	5%	RMC1/16S 472JTH	J24189033		1-	A	A1
R 1235	CHIP RES.	220	1/16W	5%	RMC1/16S 221JTH	J24189017		1-	A	A1
R 1236	CHIP RES.	4.7k	1/16W	5%	RMC1/16S 472JTH	J24189033		1-	A	A3
R 1237	CHIP RES.	220k	1/16W	5%	RMC1/16S 224JTH	J24189053		1-	A	A3
R 1238	CHIP RES.	220k	1/16W	5%	RMC1/16S 224JTH	J24189053		1-	A	A3
R 1239	CHIP RES.	220k	1/16W	5%	RMC1/16S 224JTH	J24189053		1-	A	B3
R 1240	CHIP RES.	22k	1/16W	5%	RMC1/16S 223JTH	J24189041		1-	A	A3
R 1241	CHIP RES.	22k	1/16W	5%	RMC1/16S 223JTH	J24189041		1-	A	A3
R 1242	CHIP RES.	10k	1/16W	5%	RMC1/16S 103JTH	J24189037		1-	B	f4
R 1243	CHIP RES.	10k	1/16W	5%	RMC1/16S 103JTH	J24189037		1-	B	f4
R 1244	CHIP RES.	22k	1/16W	5%	RMC1/16S 223JTH	J24189041		1-	A	B3
R 1245	CHIP RES.	390k	1/16W	5%	RMC1/16S 394JTH	J24189056		1-	A	A4
R 1246	CHIP RES.	390k	1/16W	5%	RMC1/16S 394JTH	J24189056		1-	A	A4
R 1247	CHIP RES.	47k	1/16W	5%	RMC1/16S 473JTH	J24189045		1-	A	A4
R 1248	CHIP RES.	390k	1/16W	5%	RMC1/16S 394JTH	J24189056		1-	A	A4
R 1249	CHIP RES.	390k	1/16W	5%	RMC1/16S 394JTH	J24189056		1-	A	A4
R 1250	CHIP RES.	68k	1/16W	5%	RMC1/16S 683JTH	J24189047		1-	A	A4
R 1251	CHIP RES.	68k	1/16W	5%	RMC1/16S 683JTH	J24189047		1-	A	A4

MAIN Unit

Parts List

REF	DESCRIPTION	VALUE	V/W	TOL.	MFR'S DESIG	VXSTD P/N	VERS.	LOT	SIDE	LAY ADR
R 1252	CHIP RES.	390k	1/16W	5%	RMC1/16S 394JTH	J24189056		1-	B	g4
R 1253	CHIP RES.	390k	1/16W	5%	RMC1/16S 394JTH	J24189056		1-	B	g4
R 1254	CHIP RES.	47k	1/16W	5%	RMC1/16S 473JTH	J24189045		1-	B	g4
R 1255	CHIP RES.	390k	1/16W	5%	RMC1/16S 394JTH	J24189056		1-	B	g4
R 1256	CHIP RES.	390k	1/16W	5%	RMC1/16S 394JTH	J24189056		1-	B	f5
R 1257	CHIP RES.	68k	1/16W	5%	RMC1/16S 683JTH	J24189047		1-	B	f5
R 1258	CHIP RES.	68k	1/16W	5%	RMC1/16S 683JTH	J24189047		1-	B	f5
R 1259	CHIP RES.	100k	1/16W	5%	RMC1/16S 104JTH	J24189049		1-	B	f4
R 1260	CHIP RES.	100k	1/16W	5%	RMC1/16S 104JTH	J24189049		1-	B	f4
R 1261	CHIP RES.	4.7k	1/16W	5%	RMC1/16S 472JTH	J24189033		1-	B	g1
R 1262	CHIP RES.	270	1/16W	5%	RMC1/16S 271JTH	J24189018		1-	B	g1
R 1263	CHIP RES.	270	1/16W	5%	RMC1/16S 271JTH	J24189018		1-	B	f1
R 1264	CHIP RES.	270	1/16W	5%	RMC1/16S 271JTH	J24189018		1-	B	f1
R 1265	CHIP RES.	270	1/16W	5%	RMC1/16S 271JTH	J24189018		1-	B	f1
R 1266	CHIP RES.	47k	1/16W	5%	RMC1/16S 473JTH	J24189045		1-	B	f1
R 1267	CHIP RES.	100k	1/16W	5%	RMC1/16S 104JTH	J24189049		1-	B	f2
R 1268	CHIP RES.	47	1/16W	5%	RMC1/16S 470JTH	J24189009		1-	A	A2
R 1269	CHIP RES.	100k	1/16W	5%	RMC1/16S 104JTH	J24189049		1-	B	f2
R 1270	CHIP RES.	12k	1/16W	5%	RMC1/16S 123JTH	J24189038		1-	B	f2
R 1271	CHIP RES.	100k	1/16W	5%	RMC1/16S 104JTH	J24189049		1-	B	f2
R 1272	CHIP RES.	12k	1/16W	5%	RMC1/16S 123JTH	J24189038		1-	A	A2
R 1273	CHIP RES.	100k	1/16W	5%	RMC1/16S 104JTH	J24189049		1-	B	f2
R 1274	CHIP RES.	12k	1/16W	5%	RMC1/16S 123JTH	J24189038		1-	B	f2
R 1275	CHIP RES.	220k	1/16W	5%	RMC1/16S 224JTH	J24189053		1-	B	f2
R 1276	CHIP RES.	100k	1/16W	5%	RMC1/16S 104JTH	J24189049		1-	B	f2
R 1277	CHIP RES.	12k	1/16W	5%	RMC1/16S 123JTH	J24189038		1-	B	f2
R 1278	CHIP RES.	220k	1/16W	5%	RMC1/16S 224JTH	J24189053		1-	A	A2
R 1279	CHIP RES.	100k	1/16W	5%	RMC1/16S 104JTH	J24189049		1-	B	f3
R 1280	CHIP RES.	100	1/16W	5%	RMC1/16S 101JTH	J24189013		1-	B	f2
R 1281	CHIP RES.	10	1/16W	5%	RMC1/16S 100JTH	J24189001		1-	B	g2
R 1282	CHIP RES.	10	1/16W	5%	RMC1/16S 100JTH	J24189001		1-	B	g2
R 1283	CHIP RES.	6.8M	1/16W	5%	MCR01MZSJ685	J24189327		1-	B	f2
R 1284	CHIP RES.	10k	1/16W	5%	RMC1/16S 103JTH	J24189037		1-	B	f2
R 1285	CHIP RES.	22k	1/16W	5%	RMC1/16S 223JTH	J24189041		1-	B	f3
R 1286	CHIP RES.	100	1/16W	5%	RMC1/16S 101JTH	J24189013		1-	B	f3
R 1287	CHIP RES.	22k	1/16W	5%	RMC1/16S 223JTH	J24189041		1-	B	f3
R 1288	CHIP RES.	2.2M	1/16W	5%	RMC1/16S 225JTH	J24189065		1-	B	f3
R 1291	CHIP RES.	22	1/16W	5%	RMC1/16S 220JTH	J24189005		1-	B	f3
R 1292	CHIP RES.	22	1/16W	5%	RMC1/16S 220JTH	J24189005		1-	B	f3
R 1293	CHIP RES.	2.2M	1/16W	5%	RMC1/16S 225JTH	J24189065		1-	A	B4
R 1294	CHIP RES.	27k	1/16W	5%	RMC1/16S 273JTH	J24189042		1-	A	B4
R 1295	CHIP RES.	15k	1/16W	5%	RMC1/16S 153JTH	J24189039		1-	A	B4
R 1296	CHIP RES.	220	1/16W	5%	RMC1/16S 221JTH	J24189017		1-	A	B1
R 1297	CHIP RES.	4.7k	1/16W	5%	RMC1/16S 472JTH	J24189033		1-	A	A1
R 1298	CHIP RES.	220	1/16W	5%	RMC1/16S 221JTH	J24189017		1-	A	B5
R 1299	CHIP RES.	4.7k	1/16W	5%	RMC1/16S 472JTH	J24189033		1-	A	A1
R 1300	CHIP RES.	10k	1/16W	5%	RMC1/16S 103JTH	J24189037		1-	A	B1
R 1301	CHIP RES.	100k	1/16W	5%	RMC1/16S 104JTH	J24189049		1-	A	B4
R 1302	CHIP RES.	47	1/16W	5%	RMC1/16S 470JTH	J24189009		1-	B	f4
R 1303	CHIP RES.	220k	1/16W	5%	RMC1/16S 224JTH	J24189053		1-	A	A4
R 1304	CHIP RES.	2.2k	1/16W	5%	RMC1/16S 222JTH	J24189029		1-	A	B4
R 1305	CHIP RES.	39k	1/16W	5%	RMC1/16S 393JTH	J24189044		1-	A	B4
R 1306	CHIP RES.	100k	1/16W	0.5%	RR0510R-104-D	J24189167		1-	A	A4
R 1307	CHIP RES.	56k	1/16W	0.5%	RR0510R-563-D	J24189161		1-	A	A4
R 1308	CHIP RES.	100k	1/16W	0.5%	RR0510R-104-D	J24189167		1-	A	A4
R 1309	CHIP RES.	4.7k	1/16W	5%	RMC1/16S 472JTH	J24189033		1-	B	e1
R 1310	CHIP RES.	33	1/2W	5%	RMC1/2 330JCTP	J24275330		1-	B	e1
R 1311	CHIP RES.	1k	1/16W	5%	RMC1/16S 102JTH	J24189025		1-	B	e5
R 1312	CHIP RES.	1k	1/16W	5%	RMC1/16S 102JTH	J24189025		1-	B	e5
R 1313	CHIP RES.	1k	1/16W	5%	RMC1/16S 102JTH	J24189025		1-	A	B5
R 1314	CHIP RES.	47k	1/16W	5%	RMC1/16S 473JTH	J24189045		1-	B	f5
R 1315	CHIP RES.	10k	1/16W	5%	RMC1/16S 103JTH	J24189037		1-	A	B5
R 1316	CHIP RES.	1k	1/16W	5%	RMC1/16S 102JTH	J24189025		1-	B	e5
R 1317	CHIP RES.	1k	1/16W	5%	RMC1/16S 102JTH	J24189025		1-	B	f5
R 1318	CHIP RES.	4.7k	1/16W	5%	RMC1/16S 472JTH	J24189033		1-	A	A2
R 1319	CHIP RES.	220	1/16W	5%	RMC1/16S 221JTH	J24189017		1-	A	B2
R 1320	CHIP RES.	220	1/16W	5%	RMC1/16S 221JTH	J24189017		1-	A	A2
R 1321	CHIP RES.	220	1/16W	5%	RMC1/16S 221JTH	J24189017		1-	A	A2
R 1322	CHIP RES.	220	1/16W	5%	RMC1/16S 221JTH	J24189017		1-	A	A2
R 1323	CHIP RES.	47k	1/16W	5%	RMC1/16S 473JTH	J24189045		1-	B	f3
R 1324	CHIP RES.	470k	1/16W	5%	RMC1/16S 474JTH	J24189057		1-	B	f3
R 1325	CHIP RES.	47k	1/16W	5%	RMC1/16S 473JTH	J24189045		1-	B	f3
R 1326	CHIP RES.	22k	1/16W	5%	RMC1/16S 223JTH	J24189041		1-	B	g3
R 1327	CHIP RES.	470k	1/16W	5%	RMC1/16S 474JTH	J24189057		1-	B	g4
R 1328	CHIP RES.	470k	1/16W	5%	RMC1/16S 474JTH	J24189057		1-	B	g4
R 1329	CHIP RES.	4.7k	1/16W	5%	RMC1/16S 472JTH	J24189033		1-	B	f3

MAIN Unit

Parts List

REF	DESCRIPTION	VALUE	V/W	TOL.	MFR'S DESIG	VXSTD P/N	VERS.	LOT	SIDE	LAY ADR
R 1330	CHIP RES.	68k	1/16W	5%	RMC1/16S 683JTH	J24189047		1-	B	f4
R 1331	CHIP RES.	22k	1/16W	5%	RMC1/16S 223JTH	J24189041		1-	B	f4
R 1332	CHIP RES.	100k	1/16W	0.5%	RR0510R-104-D	J24189167		1-	B	f3
R 1333	CHIP RES.	47k	1/16W	5%	RMC1/16S 473JTH	J24189045		1-	B	f5
R 1334	CHIP RES.	470	1/16W	5%	RMC1/16S 471JTH	J24189021		1-	B	f5
R 1335	CHIP RES.	1M	1/16W	5%	RMC1/16S 105JTH	J24189061		1-	B	f4
R 1336	CHIP RES.	1k	1/16W	5%	RMC1/16S 102JTH	J24189025		1-	B	f5
R 1337	CHIP RES.	1k	1/16W	5%	RMC1/16S 102JTH	J24189025		1-	B	f5
R 1338	CHIP RES.	22k	1/16W	5%	RMC1/16S 223JTH	J24189041		1-	B	f5
R 1339	CHIP RES.	2.2M	1/16W	5%	RMC1/16S 225JTH	J24189065		1-	A	A4
R 1340	CHIP RES.	4.7k	1/16W	5%	RMC1/16S 472JTH	J24189033		1-	A	A4
R 1341	CHIP RES.	22k	1/16W	5%	RMC1/16S 223JTH	J24189041		1-	A	A4
R 1342	CHIP RES.	3.9k	1/16W	5%	RMC1/16S 392JTH	J24189032		1-	A	A4
R 1343	CHIP RES.	100k	1/16W	5%	RMC1/16S 104JTH	J24189049		1-	A	A4
R 1344	CHIP RES.	220k	1/16W	5%	RMC1/16S 224JTH	J24189053		1-	A	A4
R 1345	CHIP RES.	220k	1/16W	5%	RMC1/16S 224JTH	J24189053		1-	A	A4
R 1346	CHIP RES.	330k	1/16W	5%	RMC1/16S 334JTH	J24189055		1-	A	A4
R 1347	CHIP RES.	10k	1/16W	5%	RMC1/16S 103JTH	J24189037		1-	A	A4
R 1348	CHIP RES.	68k	1/16W	5%	RMC1/16S 683JTH	J24189047		1-	A	A4
R 1349	CHIP RES.	390k	1/16W	5%	RMC1/16S 394JTH	J24189056		1-	A	A4
R 1350	CHIP RES.	150k	1/16W	5%	RMC1/16S 154JTH	J24189051		1-	A	A4
R 1351	CHIP RES.	150k	1/16W	5%	RMC1/16S 154JTH	J24189051		1-	A	A4
R 1352	CHIP RES.	10k	1/16W	5%	RMC1/16S 103JTH	J24189037		1-	A	B4
R 1353	CHIP RES.	33k	1/16W	0.5%	RR0510R-333-D	J24189155		1-	A	B4
R 1354	CHIP RES.	56k	1/16W	0.5%	RR0510R-563-D	J24189161		1-	A	B4
R 1355	CHIP RES.	1k	1/16W	5%	RMC1/16S 102JTH	J24189025		1-	A	B4
R 1356	CHIP RES.	15k	1/16W	5%	RMC1/16S 153JTH	J24189039		1-	B	b5
R 1357	CHIP RES.	4.7k	1/16W	5%	RMC1/16S 472JTH	J24189033		1-	B	b5
R 1358	CHIP RES.	1k	1/16W	5%	RMC1/16S 102JTH	J24189025		1-	A	E5
R 1359	CHIP RES.	2.2k	1/16W	5%	RMC1/16S 222JTH	J24189029		1-	A	E5
R 1360	CHIP RES.	100k	1/16W	5%	RMC1/16S 104JTH	J24189049		1-	A	E4
R 1361	CHIP RES.	2.2k	1/16W	5%	RMC1/16S 222JTH	J24189029		1-	A	E5
R 1362	CHIP RES.	2.2k	1/16W	5%	RMC1/16S 222JTH	J24189029		1-	A	E4
R 1363	CHIP RES.	100k	1/16W	5%	RMC1/16S 104JTH	J24189049		1-	A	E4
R 1364	CHIP RES.	2.2k	1/16W	5%	RMC1/16S 222JTH	J24189029		1-	A	E5
R 1365	CHIP RES.	100k	1/16W	5%	RMC1/16S 104JTH	J24189049		1-	A	E4
R 1366	CHIP RES.	100k	1/16W	5%	RMC1/16S 104JTH	J24189049		1-	A	E4
R 1367	CHIP RES.	1k	1/16W	5%	RMC1/16S 102JTH	J24189025		1-	A	E5
R 1370	CHIP RES.	1k	1/16W	5%	RMC1/16S 102JTH	J24189025		1-	A	A5
R 1371	CHIP RES.	1k	1/16W	5%	RMC1/16S 102JTH	J24189025		1-	B	f5
R 1372	CHIP RES.	100	1/16W	5%	RMC1/16S 101JTH	J24189013		1-	B	f5
R 1373	CHIP RES.	100	1/16W	5%	RMC1/16S 101JTH	J24189013		1-	B	f5
R 1374	CHIP RES.	1k	1/16W	5%	RMC1/16S 102JTH	J24189025		1-	A	A5
R 1375	CHIP RES.	1k	1/16W	5%	RMC1/16S 102JTH	J24189025		1-	A	A5
R 1376	CHIP RES.	0	1/16W	5%	RMC1/16S JPTH	J24189070	TYP: B1	1-	A	A5
R 1376	CHIP RES.	0	1/16W	5%	RMC1/16S JPTH	J24189070	TYP: B2	1-	A	A5
R 1376	CHIP RES.	0	1/16W	5%	RMC1/16S JPTH	J24189070	A2 DST: USA	1-	A	A5
R 1376	CHIP RES.	0	1/16W	5%	RMC1/16S JPTH	J24189070	VER: A1	1-	A	A5
R 1376	CHIP RES.	0	1/16W	5%	RMC1/16S JPTH	J24189070	VER: A2	1-	A	A5
R 1376	CHIP RES.	0	1/16W	5%	RMC1/16S JPTH	J24189070	VER: C1	1-	A	A5
R 1376	CHIP RES.	0	1/16W	5%	RMC1/16S JPTH	J24189070	VER: C2	1-	A	A5
R 1376	CHIP RES.	0	1/16W	5%	RMC1/16S JPTH	J24189070	VER: D1	1-	A	A5
R 1376	CHIP RES.	0	1/16W	5%	RMC1/16S JPTH	J24189070	VER: D2	1-	A	A5
R 1377	CHIP RES.	0	1/16W	5%	RMC1/16S JPTH	J24189070	TYP:B1 GRM	1-	A	A5
R 1377	CHIP RES.	0	1/16W	5%	RMC1/16S JPTH	J24189070	TYP:B2 GRM	1-	A	A5
R 1377	CHIP RES.	0	1/16W	5%	RMC1/16S JPTH	J24189070	VER: B1	1-	A	A5
R 1377	CHIP RES.	0	1/16W	5%	RMC1/16S JPTH	J24189070	VER: B2	1-	A	A5
R 1377	CHIP RES.	0	1/16W	5%	RMC1/16S JPTH	J24189070	VER: C3	1-	A	A5
R 1377	CHIP RES.	0	1/16W	5%	RMC1/16S JPTH	J24189070	VER: D1	1-	A	A5
R 1377	CHIP RES.	0	1/16W	5%	RMC1/16S JPTH	J24189070	VER: D2	1-	A	A5
R 1378	CHIP RES.	0	1/16W	5%	RMC1/16S JPTH	J24189070	VER: B3	1-	A	A5
R 1378	CHIP RES.	0	1/16W	5%	RMC1/16S JPTH	J24189070	VER: C1	1-	A	A5
R 1378	CHIP RES.	0	1/16W	5%	RMC1/16S JPTH	J24189070	VER: C2	1-	A	A5
R 1378	CHIP RES.	0	1/16W	5%	RMC1/16S JPTH	J24189070	VER: C3	1-	A	A5
R 1378	CHIP RES.	0	1/16W	5%	RMC1/16S JPTH	J24189070	VER: D1	1-	A	A5
R 1378	CHIP RES.	0	1/16W	5%	RMC1/16S JPTH	J24189070	VER: D2	1-	A	A5
R 1379	CHIP RES.	0	1/16W	5%	RMC1/16S JPTH	J24189070	VER: FH	1-	A	A5
R 1379	CHIP RES.	0	1/16W	5%	RMC1/16S JPTH	J24189070	VER: F	1-	A	A5
R 1382	CHIP RES.	0	1/16W	5%	RMC1/16S JPTH	J24189070	A2 DST:USA	1-	A	A5
R 1383	CHIP RES.	0	1/16W	5%	RMC1/16S JPTH	J24189070	TYP:B1 GRM	1-	A	A5
R 1383	CHIP RES.	0	1/16W	5%	RMC1/16S JPTH	J24189070	VER: FH	1-	A	A5
R 1383	CHIP RES.	0	1/16W	5%	RMC1/16S JPTH	J24189070	VER: A1	1-	A	A5
R 1383	CHIP RES.	0	1/16W	5%	RMC1/16S JPTH	J24189070	VER: B1	1-	A	A5
R 1383	CHIP RES.	0	1/16W	5%	RMC1/16S JPTH	J24189070	VER: C1	1-	A	A5
R 1383	CHIP RES.	0	1/16W	5%	RMC1/16S JPTH	J24189070	VER: D1	1-	A	A5
R 1383	CHIP RES.	0	1/16W	5%	RMC1/16S JPTH	J24189070	VER: F	1-	A	A5

MAIN Unit

Parts List

REF	DESCRIPTION	VALUE	V/W	TOL.	MFR'S DESIG	VXSTD P/N	VERS.	LOT	SIDE	LAY ADR
R 1384	CHIP RES.	1k	1/16W	5%	RMC1/16S 102JTH	J24189025		1-	A	A5
R 1385	CHIP RES.	1k	1/16W	5%	RMC1/16S 102JTH	J24189025		1-	A	A5
R 1386	CHIP RES.	1k	1/16W	5%	RMC1/16S 102JTH	J24189025		1-	A	A5
R 1387	CHIP RES.	1k	1/16W	5%	RMC1/16S 102JTH	J24189025		1-	A	A5
R 1388	CHIP RES.	1k	1/16W	5%	RMC1/16S 102JTH	J24189025		1-	A	A4
R 1389	CHIP RES.	1k	1/16W	5%	RMC1/16S 102JTH	J24189025		1-	B	f5
R 1390	CHIP RES.	1k	1/16W	5%	RMC1/16S 102JTH	J24189025		1-	A	A4
R 1391	CHIP RES.	1k	1/16W	5%	RMC1/16S 102JTH	J24189025		1-	A	A4
R 1392	CHIP RES.	1k	1/16W	5%	RMC1/16S 102JTH	J24189025		1-	A	A4
R 1393	CHIP RES.	1k	1/16W	5%	RMC1/16S 102JTH	J24189025		1-	A	A4
R 1394	CHIP RES.	1k	1/16W	5%	RMC1/16S 102JTH	J24189025		1-	A	A4
R 1395	CHIP RES.	1k	1/16W	5%	RMC1/16S 102JTH	J24189025		1-	B	f5
R 1396	CHIP RES.	1k	1/16W	5%	RMC1/16S 102JTH	J24189025		1-	A	A4
R 1397	CHIP RES.	1k	1/16W	5%	RMC1/16S 102JTH	J24189025		1-	A	B5
R 1398	CHIP RES.	1k	1/16W	5%	RMC1/16S 102JTH	J24189025		1-	A	B5
R 1399	CHIP RES.	1k	1/16W	5%	RMC1/16S 102JTH	J24189025		1-	A	B5
R 1400	CHIP RES.	1k	1/16W	5%	RMC1/16S 102JTH	J24189025		1-	A	B5
R 1401	CHIP RES.	1k	1/16W	5%	RMC1/16S 102JTH	J24189025		1-	A	B5
R 1402	CHIP RES.	1k	1/16W	5%	RMC1/16S 102JTH	J24189025		1-	A	B5
R 1403	CHIP RES.	10k	1/16W	5%	RMC1/16S 103JTH	J24189037		1-	B	f5
R 1404	CHIP RES.	100	1/16W	5%	RMC1/16S 101JTH	J24189013		1-	B	f5
R 1405	CHIP RES.	1k	1/16W	5%	RMC1/16S 102JTH	J24189025		1-	B	f5
R 1406	CHIP RES.	1k	1/16W	5%	RMC1/16S 102JTH	J24189025		1-	B	f5
R 1407	CHIP RES.	1k	1/16W	5%	RMC1/16S 102JTH	J24189025		1-	A	B5
R 1408	CHIP RES.	1k	1/16W	5%	RMC1/16S 102JTH	J24189025		1-	A	B5
R 1409	CHIP RES.	1k	1/16W	5%	RMC1/16S 102JTH	J24189025		1-	A	B5
R 1410	CHIP RES.	1k	1/16W	5%	RMC1/16S 102JTH	J24189025		1-	A	B5
R 1411	CHIP RES.	1k	1/16W	5%	RMC1/16S 102JTH	J24189025		1-	A	B5
R 1412	CHIP RES.	1k	1/16W	5%	RMC1/16S 102JTH	J24189025		1-	B	f5
R 1413	CHIP RES.	1k	1/16W	5%	RMC1/16S 102JTH	J24189025		1-	A	B5
R 1414	CHIP RES.	1k	1/16W	5%	RMC1/16S 102JTH	J24189025		1-	A	B5
R 1415	CHIP RES.	1k	1/16W	5%	RMC1/16S 102JTH	J24189025		1-	B	f5
R 1416	CHIP RES.	1k	1/16W	5%	RMC1/16S 102JTH	J24189025		1-	A	B5
R 1417	CHIP RES.	1k	1/16W	5%	RMC1/16S 102JTH	J24189025		1-	A	B5
R 1418	CHIP RES.	47k	1/16W	5%	RMC1/16S 473JTH	J24189045		1-	A	A1
R 1419	CHIP RES.	47k	1/16W	5%	RMC1/16S 473JTH	J24189045		1-	B	f3
R 1420	CHIP RES.	100k	1/16W	0.5%	RR0510R-104-D	J24189167		1-	A	B4
R 1421	CHIP RES.	100k	1/16W	0.5%	RR0510R-104-D	J24189167		1-	A	B4
R 1422	CHIP RES.	100k	1/16W	0.5%	RR0510R-104-D	J24189167		1-	A	B4
R 1423	CHIP RES.	100k	1/16W	0.5%	RR0510R-104-D	J24189167		1-	A	B5
R 1424	CHIP RES.	100k	1/16W	0.5%	RR0510R-104-D	J24189167		1-	A	B4
R 1425	CHIP RES.	390k	1/16W	5%	RMC1/16S 394JTH	J24189056		1-	A	B4
R 1426	CHIP RES.	820k	1/16W	5%	RMC1/16S 824JTH	J24189060		1-	A	B4
R 1427	CHIP RES.	1.5M	1/16W	5%	RMC1/16S 155JTH	J24189063		1-	A	A4
R 1428	CHIP RES.	1k	1/16W	5%	RMC1/16S 102JTH	J24189025		1-	B	f5
R 1429	CHIP RES.	1k	1/16W	5%	RMC1/16S 102JTH	J24189025		1-	B	f5
R 1430	CHIP RES.	1k	1/16W	5%	RMC1/16S 102JTH	J24189025		1-	B	f5
R 1431	CHIP RES.	100k	1/16W	0.5%	RR0510R-104-D	J24189167		1-	B	f5
R 1432	CHIP RES.	100k	1/16W	0.5%	RR0510R-104-D	J24189167		1-	B	f3
R 1433	CHIP RES.	100k	1/16W	0.5%	RR0510R-104-D	J24189167		1-	B	f3
R 1434	CHIP RES.	2.2k	1/16W	0.5%	RR0510P-222-D	J24189127		1-	B	e3
R 1435	CHIP RES.	1k	1/16W	5%	RMC1/16S 102JTH	J24189025		1-	A	B5
R 1436	CHIP RES.	100k	1/16W	5%	RMC1/16S 104JTH	J24189049		1-	B	e4
R 1437	CHIP RES.	22k	1/16W	5%	RMC1/16S 223JTH	J24189041		1-	B	e4
R 1438	CHIP RES.	22k	1/16W	5%	RMC1/16S 223JTH	J24189041		1-	A	B4
R 1439	CHIP RES.	82k	1/16W	5%	RMC1/16S 823JTH	J24189048		1-	A	B3
R 1440	CHIP RES.	100k	1/16W	5%	RMC1/16S 104JTH	J24189049		1-	A	B4
R 1441	CHIP RES.	33k	1/16W	5%	RMC1/16S 333JTH	J24189043		1-	B	e3
R 1442	CHIP RES.	39k	1/16W	5%	RMC1/16S 393JTH	J24189044		1-	B	e4
R 1443	CHIP RES.	100k	1/16W	5%	RMC1/16S 104JTH	J24189049		1-	B	e4
R 1444	CHIP RES.	68k	1/16W	5%	RMC1/16S 683JTH	J24189047		1-	A	C5
R 1445	CHIP RES.	100	1/16W	5%	RMC1/16S 101JTH	J24189013		1-	A	B4
R 1446	CHIP RES.	47k	1/16W	5%	RMC1/16S 473JTH	J24189045		1-	B	e4
R 1447	CHIP RES.	15k	1/16W	5%	RMC1/16S 153JTH	J24189039		1-	B	e4
R 1448	CHIP RES.	22k	1/16W	5%	RMC1/16S 223JTH	J24189041		1-	A	C3
R 1449	CHIP RES.	100k	1/16W	5%	RMC1/16S 104JTH	J24189049		1-	A	C3
R 1450	CHIP RES.	680k	1/16W	5%	RMC1/16S 684JTH	J24189059		1-	A	C4
R 1451	CHIP RES.	220k	1/16W	5%	RMC1/16S 224JTH	J24189053		1-	A	C4
R 1452	CHIP RES.	47	1/16W	5%	RMC1/16S 470JTH	J24189009		1-	A	B4
R 1453	CHIP RES.	100	1/16W	5%	RMC1/16S 101JTH	J24189013		1-	B	d4
R 1454	CHIP RES.	470k	1/16W	5%	RMC1/16S 474JTH	J24189057		1-	B	d3
R 1455	CHIP RES.	120k	1/16W	5%	RMC1/16S 124JTH	J24189050		1-	B	e4
R 1456	CHIP RES.	82k	1/16W	5%	RMC1/16S 823JTH	J24189048		1-	B	e4
R 1457	CHIP RES.	100k	1/16W	5%	RMC1/16S 104JTH	J24189049		1-	B	e4
R 1458	CHIP RES.	470k	1/16W	5%	RMC1/16S 474JTH	J24189057		1-	B	e4
R 1459	CHIP RES.	100k	1/16W	5%	RMC1/16S 104JTH	J24189049		1-	B	e4

MAIN Unit

Parts List

REF	DESCRIPTION	VALUE	V/W	TOL.	MFR'S DESIG	VXSTD P/N	VERS.	LOT	SIDE	LAY ADR
R 1460	CHIP RES.	10k	1/16W	5%	RMC1/16S 103JTH	J24189037		1-	A	C3
R 1461	CHIP RES.	10k	1/16W	5%	RMC1/16S 103JTH	J24189037		1-	A	C3
R 1462	CHIP RES.	10k	1/16W	5%	RMC1/16S 103JTH	J24189037		1-	A	C3
R 1463	CHIP RES.	47k	1/16W	5%	RMC1/16S 473JTH	J24189045		1-	A	C4
R 1464	CHIP RES.	10	1/16W	5%	RMC1/16S 100JTH	J24189001		1-	A	B4
R 1465	CHIP RES.	2.2k	1/16W	5%	RMC1/16S 222JTH	J24189029		1-	A	C4
R 1466	CHIP RES.	22k	1/16W	5%	RMC1/16S 223JTH	J24189041		1-	A	C4
R 1467	CHIP RES.	22k	1/16W	5%	RMC1/16S 223JTH	J24189041		1-	A	C4
R 1468	CHIP RES.	47k	1/16W	5%	RMC1/16S 473JTH	J24189045		1-	B	e4
R 1469	CHIP RES.	47k	1/16W	5%	RMC1/16S 473JTH	J24189045		1-	A	C4
R 1470	CHIP RES.	150k	1/16W	5%	RMC1/16S 154JTH	J24189051		1-	B	e4
R 1471	CHIP RES.	330k	1/16W	5%	RMC1/16S 334JTH	J24189055		1-	B	e4
R 1472	CHIP RES.	82k	1/16W	5%	RMC1/16S 823JTH	J24189048		1-	B	e4
R 1473	CHIP RES.	18k	1/16W	5%	RMC1/16S 183JTH	J24189040		1-	B	e4
R 1474	CHIP RES.	680	1/16W	5%	RMC1/16S 681JTH	J24189023		1-	A	C4
R 1475	CHIP RES.	680	1/16W	5%	RMC1/16S 681JTH	J24189023		1-	A	C4
R 1476	CHIP RES.	10	1/16W	5%	RMC1/16S 100JTH	J24189001		1-	A	C4
R 1477	CHIP RES.	0	1/16W	5%	RMC1/16S JPTH	J24189070		1-	A	C4
R 1478	CHIP RES.	22k	1/16W	5%	RMC1/16S 223JTH	J24189041		1-	B	c5
R 1479	CHIP RES.	100k	1/16W	5%	RMC1/16S 104JTH	J24189049		1-	B	c5
R 1480	CHIP RES.	680k	1/16W	5%	RMC1/16S 684JTH	J24189059		1-	B	c5
R 1481	CHIP RES.	220k	1/16W	5%	RMC1/16S 224JTH	J24189053		1-	B	c5
R 1482	CHIP RES.	47	1/16W	5%	RMC1/16S 470JTH	J24189009		1-	B	c5
R 1483	CHIP RES.	100	1/16W	5%	RMC1/16S 101JTH	J24189013		1-	B	c5
R 1485	CHIP RES.	22k	1/16W	5%	RMC1/16S 223JTH	J24189041		1-	B	d4
R 1486	CHIP RES.	47k	1/16W	5%	RMC1/16S 473JTH	J24189045		1-	B	d5
R 1488	CHIP RES.	470k	1/16W	5%	RMC1/16S 474JTH	J24189057		1-	B	d5
R 1489	CHIP RES.	120k	1/16W	5%	RMC1/16S 124JTH	J24189050		1-	B	d5
R 1490	CHIP RES.	82k	1/16W	5%	RMC1/16S 823JTH	J24189048		1-	B	d5
R 1491	CHIP RES.	470k	1/16W	5%	RMC1/16S 474JTH	J24189057		1-	B	d4
R 1492	CHIP RES.	120k	1/16W	5%	RMC1/16S 124JTH	J24189050		1-	B	c5
R 1493	CHIP RES.	82k	1/16W	5%	RMC1/16S 823JTH	J24189048		1-	B	c5
R 1494	CHIP RES.	6.8k	1/16W	5%	RMC1/16S 682JTH	J24189035		1-	B	d5
R 1495	CHIP RES.	10k	1/16W	5%	RMC1/16S 103JTH	J24189037		1-	B	c5
R 1496	CHIP RES.	10k	1/16W	5%	RMC1/16S 103JTH	J24189037		1-	B	c5
R 1497	CHIP RES.	10k	1/16W	5%	RMC1/16S 103JTH	J24189037		1-	B	c5
R 1498	CHIP RES.	100	1/16W	5%	RMC1/16S 101JTH	J24189013		1-	B	c5
R 1499	CHIP RES.	33k	1/16W	5%	RMC1/16S 333JTH	J24189043		1-	B	c5
R 1500	CHIP RES.	22k	1/16W	5%	RMC1/16S 223JTH	J24189041		1-	B	c5
R 1501	CHIP RES.	22k	1/16W	5%	RMC1/16S 223JTH	J24189041		1-	B	c5
R 1502	CHIP RES.	33k	1/16W	5%	RMC1/16S 333JTH	J24189043		1-	B	c5
R 1503	CHIP RES.	100	1/16W	5%	RMC1/16S 101JTH	J24189013		1-	B	c5
R 1504	CHIP RES.	680	1/16W	5%	RMC1/16S 681JTH	J24189023		1-	B	c5
R 1505	CHIP RES.	2.2k	1/16W	5%	RMC1/16S 222JTH	J24189029		1-	B	d5
R 1506	CHIP RES.	680	1/16W	5%	RMC1/16S 681JTH	J24189023		1-	B	d5
R 1508	CHIP RES.	2.2k	1/16W	5%	RMC1/16S 222JTH	J24189029		1-	B	d5
R 1509	CHIP RES.	330k	1/16W	5%	RMC1/16S 334JTH	J24189055		1-	B	d4
R 1510	CHIP RES.	47k	1/16W	5%	RMC1/16S 473JTH	J24189045		1-	B	c5
R 1511	CHIP RES.	150k	1/16W	5%	RMC1/16S 154JTH	J24189051		1-	B	d5
R 1512	CHIP RES.	18k	1/16W	5%	RMC1/16S 183JTH	J24189040		1-	B	d4
R 1513	CHIP RES.	82k	1/16W	5%	RMC1/16S 823JTH	J24189048		1-	B	d5
R 1515	CHIP RES.	47k	1/16W	5%	RMC1/16S 473JTH	J24189045		1-	A	D5
R 1516	CHIP RES.	2.2k	1/16W	5%	RMC1/16S 222JTH	J24189029		1-	A	C4
R 1517	CHIP RES.	560k	1/16W	5%	RMC1/16S 564JTH	J24189058		1-	B	d4
R 1518	CHIP RES.	220	1/16W	5%	RMC1/16S 221JTH	J24189017		1-	B	d4
R 1519	CHIP RES.	3.3k	1/16W	5%	RMC1/16S 332JTH	J24189031		1-	B	d4
R 1520	CHIP RES.	15k	1/16W	5%	RMC1/16S 153JTH	J24189039		1-	B	d4
R 1521	CHIP RES.	22k	1/16W	5%	RMC1/16S 223JTH	J24189041		1-	B	d4
R 1522	CHIP RES.	47	1/16W	5%	RMC1/16S 470JTH	J24189009		1-	B	d4
R 1523	CHIP RES.	470	1/16W	5%	RMC1/16S 471JTH	J24189021		1-	B	d4
R 1524	CHIP RES.	33k	1/16W	5%	RMC1/16S 333JTH	J24189043		1-	B	d4
R 1525	CHIP RES.	680	1/16W	5%	RMC1/16S 681JTH	J24189023		1-	B	d4
R 1526	CHIP RES.	100	1/16W	5%	RMC1/16S 101JTH	J24189013		1-	A	C4
R 1527	CHIP RES.	47	1/16W	5%	RMC1/16S 470JTH	J24189009		1-	A	C4
R 1528	CHIP RES.	10k	1/16W	5%	RMC1/16S 103JTH	J24189037		1-	A	C4
R 1529	CHIP RES.	100	1/16W	5%	RMC1/16S 101JTH	J24189013		1-	A	D4
R 1530	CHIP RES.	100	1/16W	5%	RMC1/16S 101JTH	J24189013		1-	A	D4
R 1531	CHIP RES.	3.3k	1/16W	5%	RMC1/16S 332JTH	J24189031		1-	A	C4
R 1532	CHIP RES.	2.2k	1/16W	5%	RMC1/16S 222JTH	J24189029		1-	A	C4
R 1533	CHIP RES.	270k	1/16W	5%	RMC1/16S 274JTH	J24189054		1-	B	d4
R 1534	CHIP RES.	330	1/16W	5%	RMC1/16S 331JTH	J24189019		1-	B	d4
R 1535	CHIP RES.	2.2k	1/16W	5%	RMC1/16S 222JTH	J24189029		1-	B	d4
R 1536	CHIP RES.	15k	1/16W	5%	RMC1/16S 153JTH	J24189039		1-	B	d4
R 1537	CHIP RES.	22k	1/16W	5%	RMC1/16S 223JTH	J24189041		1-	B	d4
R 1538	CHIP RES.	1k	1/16W	5%	RMC1/16S 102JTH	J24189025		1-	B	d4

MAIN Unit

Parts List

REF	DESCRIPTION	VALUE	V/W	TOL.	MFR'S DESIG	VXSTD P/N	VERS.	LOT	SIDE	LAY ADR
R 1539	CHIP RES.	220	1/16W	5%	RMC1/16S 221JTH	J24189017		1-	B	d4
R 1540	CHIP RES.	1k	1/16W	5%	RMC1/16S 102JTH	J24189025		1-	B	d4
R 1541	CHIP RES.	33k	1/16W	5%	RMC1/16S 333JTH	J24189043		1-	B	d4
R 1542	CHIP RES.	220	1/16W	5%	RMC1/16S 221JTH	J24189017		1-	A	C4
R 1543	CHIP RES.	47	1/16W	5%	RMC1/16S 470JTH	J24189009		1-	A	D4
R 1544	CHIP RES.	100k	1/16W	5%	RMC1/16S 104JTH	J24189049		1-	A	D4
R 1545	CHIP RES.	10k	1/16W	5%	RMC1/16S 103JTH	J24189037		1-	A	C4
R 1546	CHIP RES.	2.2k	1/16W	5%	RMC1/16S 222JTH	J24189029		1-	A	D5
R 1547	CHIP RES.	15k	1/16W	5%	RMC1/16S 153JTH	J24189039		1-	A	D5
R 1548	CHIP RES.	22k	1/16W	5%	RMC1/16S 223JTH	J24189041		1-	A	D5
R 1549	CHIP RES.	680	1/16W	5%	RMC1/16S 681JTH	J24189023		1-	A	D5
R 1550	CHIP RES.	100	1/16W	5%	RMC1/16S 101JTH	J24189013		1-	A	D5
R 1551	CHIP RES.	820	1/16W	5%	RMC1/16S 821JTH	J24189024		1-	A	D5
R 1552	CHIP RES.	33k	1/16W	5%	RMC1/16S 333JTH	J24189043		1-	A	D5
R 1553	CHIP RES.	100k	1/16W	5%	RMC1/16S 104JTH	J24189049		1-	A	E5
R 1554	CHIP RES.	100	1/16W	5%	RMC1/16S 101JTH	J24189013		1-	A	E5
R 1555	CHIP RES.	4.7k	1/16W	5%	RMC1/16S 472JTH	J24189033		1-	B	e4
R 1556	CHIP RES.	3.3k	1/16W	5%	RMC1/16S 332JTH	J24189031		1-	A	D5
R 1559	CHIP RES.	220	1/16W	5%	RMC1/16S 221JTH	J24189017		1-	A	D5
R 1560	CHIP RES.	2.2k	1/16W	5%	RMC1/16S 222JTH	J24189029		1-	A	D5
R 1561	CHIP RES.	15k	1/16W	5%	RMC1/16S 153JTH	J24189039		1-	A	D5
R 1562	CHIP RES.	22k	1/16W	5%	RMC1/16S 223JTH	J24189041		1-	A	D5
R 1563	CHIP RES.	1k	1/16W	5%	RMC1/16S 102JTH	J24189025		1-	A	D5
R 1564	CHIP RES.	220	1/16W	5%	RMC1/16S 221JTH	J24189017		1-	A	D5
R 1565	CHIP RES.	1k	1/16W	5%	RMC1/16S 102JTH	J24189025		1-	A	D5
R 1566	CHIP RES.	33k	1/16W	5%	RMC1/16S 333JTH	J24189043		1-	A	D5
R 1567	CHIP RES.	100	1/16W	5%	RMC1/16S 101JTH	J24189013		1-	B	c5
R 1568	CHIP RES.	100	1/16W	5%	RMC1/16S 101JTH	J24189013		1-	B	c5
R 1569	CHIP RES.	47	1/16W	5%	RMC1/16S 470JTH	J24189009		1-	A	E5
R 1570	CHIP RES.	100k	1/16W	5%	RMC1/16S 104JTH	J24189049		1-	A	E5
R 1573	CHIP RES.	10k	1/16W	5%	RMC1/16S 103JTH	J24189037		1-	B	c5
R 1574	CHIP RES.	2.2k	1/16W	5%	RMC1/16S 222JTH	J24189029		1-	B	c4
R 1575	CHIP RES.	100	1/16W	5%	RMC1/16S 101JTH	J24189013		1-	B	c4
R 1576	CHIP RES.	470k	1/16W	5%	RMC1/16S 474JTH	J24189057		1-	B	c4
R 1577	CHIP RES.	39k	1/16W	0.5%	RR0510R-393-D	J24189157		1-	B	d4
R 1578	CHIP RES.	560	1/16W	0.5%	RR0510P-561-D	J24189113		1-	B	c4
R 1579	CHIP RES.	2.2k	1/16W	5%	RMC1/16S 222JTH	J24189029		1-	B	c5
R 1580	CHIP RES.	15k	1/16W	5%	RMC1/16S 153JTH	J24189039		1-	B	c4
R 1581	CHIP RES.	22k	1/16W	5%	RMC1/16S 223JTH	J24189041		1-	B	c4
R 1582	CHIP RES.	680	1/16W	5%	RMC1/16S 681JTH	J24189023		1-	B	c4
R 1583	CHIP RES.	47	1/16W	5%	RMC1/16S 470JTH	J24189009		1-	B	c4
R 1584	CHIP RES.	1k	1/16W	5%	RMC1/16S 102JTH	J24189025		1-	B	c4
R 1585	CHIP RES.	1k	1/16W	5%	RMC1/16S 102JTH	J24189025		1-	A	D5
R 1586	CHIP RES.	33k	1/16W	5%	RMC1/16S 333JTH	J24189043		1-	B	c4
R 1587	CHIP RES.	1k	1/16W	5%	RMC1/16S 102JTH	J24189025		1-	A	E5
R 1588	CHIP RES.	47	1/16W	5%	RMC1/16S 470JTH	J24189009		1-	A	D4
R 1589	CHIP RES.	1k	1/16W	5%	RMC1/16S 102JTH	J24189025		1-	B	c5
R 1590	CHIP RES.	2.2k	1/16W	5%	RMC1/16S 222JTH	J24189029		1-	B	c4
R 1591	CHIP RES.	15k	1/16W	5%	RMC1/16S 153JTH	J24189039		1-	B	c4
R 1592	CHIP RES.	22k	1/16W	5%	RMC1/16S 223JTH	J24189041		1-	B	c4
R 1593	CHIP RES.	680	1/16W	5%	RMC1/16S 681JTH	J24189023		1-	B	b4
R 1594	CHIP RES.	47	1/16W	5%	RMC1/16S 470JTH	J24189009		1-	B	c5
R 1595	CHIP RES.	1k	1/16W	5%	RMC1/16S 102JTH	J24189025		1-	B	c5
R 1596	CHIP RES.	33k	1/16W	5%	RMC1/16S 333JTH	J24189043		1-	B	b5
R 1597	CHIP RES.	100	1/16W	5%	RMC1/16S 101JTH	J24189013		1-	A	E5
R 1598	CHIP RES.	470k	1/16W	5%	RMC1/16S 474JTH	J24189057		1-	A	E5
R 1599	CHIP RES.	1k	1/16W	5%	RMC1/16S 102JTH	J24189025		1-	A	D4
R 1600	CHIP RES.	220	1/2W	5%	RMC1/2 221JCTP	J24275221		1-	B	d3
R 1601	CHIP RES.	68	1W	5%	RMC1 680JTE	J24305680		1-	B	b2
R 1602	CHIP RES.	10k	1/16W	5%	RMC1/16S 103JTH	J24189037		1-	B	b2
R 1603	CHIP RES.	10k	1/16W	5%	RMC1/16S 103JTH	J24189037		1-	B	b2
R 1604	CHIP RES.	10k	1/16W	5%	RMC1/16S 103JTH	J24189037		1-	B	b2
R 1605	CHIP RES.	10k	1/16W	5%	RMC1/16S 103JTH	J24189037		1-	B	b2
R 1607	CHIP RES.	82	1/16W	5%	RMC1/16S 820JTH	J24189012		1-	A	F3
R 1608	CHIP RES.	82	1/16W	5%	RMC1/16S 820JTH	J24189012		1-	B	a1
R 1609	CHIP RES.	22k	1/16W	5%	RMC1/16S 223JTH	J24189041		1-	B	b1
R 1610	CHIP RES.	22	1/16W	5%	RMC1/16S 220JTH	J24189005		1-	B	b4
R 1611	CHIP RES.	10k	1/16W	5%	RMC1/16S 103JTH	J24189037		1-	B	b1
R 1612	CHIP RES.	10k	1/16W	5%	RMC1/16S 103JTH	J24189037		1-	B	b2
R 1613	CHIP RES.	10k	1/16W	5%	RMC1/16S 103JTH	J24189037		1-	B	b2
R 1614	CHIP RES.	10k	1/16W	5%	RMC1/16S 103JTH	J24189037		1-	B	a1
R 1615	CHIP RES.	22	1/16W	5%	RMC1/16S 220JTH	J24189005		1-	B	b4
R 1617	CHIP RES.	22k	1/16W	5%	RMC1/16S 223JTH	J24189041		1-	B	c3
R 1618	CHIP RES.	10k	1/16W	5%	RMC1/16S 103JTH	J24189037		1-	B	b3
R 1619	CHIP RES.	10k	1/16W	5%	RMC1/16S 103JTH	J24189037		1-	B	b3
R 1620	CHIP RES.	10k	1/16W	5%	RMC1/16S 103JTH	J24189037		1-	B	c2

MAIN Unit

Parts List

REF	DESCRIPTION	VALUE	V/W	TOL.	MFR'S DESIG	VXSTD P/N	VERS.	LOT	SIDE	LAY ADR
R 1621	CHIP RES.	10k	1/16W	5%	RMC1/16S 103JTH	J24189037		1-	B	c3
R 1622	CHIP RES.	10k	1/16W	5%	RMC1/16S 103JTH	J24189037		1-	B	c3
R 1623	CHIP RES.	10k	1/16W	5%	RMC1/16S 103JTH	J24189037		1-	B	c3
R 1624	CHIP RES.	10k	1/16W	5%	RMC1/16S 103JTH	J24189037		1-	B	b3
R 1625	CHIP RES.	10k	1/16W	5%	RMC1/16S 103JTH	J24189037		1-	B	b3
R 1626	CHIP RES.	22	1/16W	5%	RMC1/16S 220JTH	J24189005		1-	B	b4
R 1627	CHIP RES.	10k	1/16W	5%	RMC1/16S 103JTH	J24189037		1-	B	a1
R 1628	CHIP RES.	100k	1/16W	5%	RMC1/16S 104JTH	J24189049		1-	B	f3
R 1629	CHIP RES.	10k	1/16W	5%	RMC1/16S 103JTH	J24189037		1-	B	f3
R 1630	CHIP RES.	10k	1/16W	5%	RMC1/16S 103JTH	J24189037		1-	B	f3
R 1631	CHIP RES.	2.2M	1/16W	5%	RMC1/16S 225JTH	J24189065		1-	B	f3
R 1632	CHIP RES.	33k	1/16W	5%	RMC1/16S 333JTH	J24189043		1-	B	f3
R 1633	CHIP RES.	470k	1/16W	5%	RMC1/16S 474JTH	J24189057		1-	B	f3
R 1634	CHIP RES.	1k	1/16W	5%	RMC1/16S 102JTH	J24189025		1-	B	e3
R 1635	CHIP RES.	1k	1/16W	5%	RMC1/16S 102JTH	J24189025		1-	B	c3
R 1636	CHIP RES.	330k	1/16W	5%	RMC1/16S 334JTH	J24189055		1-	B	e3
R 1637	CHIP RES.	3.3k	1/16W	5%	RMC1/16S 332JTH	J24189031		1-	B	e3
R 1638	CHIP RES.	6.8k	1/16W	5%	RMC1/16S 682JTH	J24189035		1-	B	e3
R 1639	CHIP RES.	100	1/16W	5%	RMC1/16S 101JTH	J24189013		1-	B	e3
R 1640	CHIP RES.	33k	1/16W	5%	RMC1/16S 333JTH	J24189043		1-	B	c3
R 1641	CHIP RES.	0	1/16W	5%	RMC1/16S JPTH	J24189070		1-	A	E4
R 1650	CHIP RES.	8.2k	1/16W	5%	RMC1/16S 822JTH	J24189036		1-	B	e3
R 1651	CHIP RES.	22k	1/16W	5%	RMC1/16S 223JTH	J24189041		1-	B	e1
R 1652	CHIP RES.	82	1/16W	5%	RMC1/16S 820JTH	J24189012		1-	B	e1
R 1654	CHIP RES.	2.2k	1/16W	5%	RMC1/16S 222JTH	J24189029		1-	B	e2
R 1655	CHIP RES.	68	1/16W	5%	RMC1/16S 680JTH	J24189011		1-	B	e2
R 1656	CHIP RES.	3.9k	1/16W	5%	RMC1/16S 392JTH	J24189032		1-	B	e2
R 1657	CHIP RES.	68	1/16W	5%	RMC1/16S 680JTH	J24189011		1-	B	e2
R 1658	CHIP RES.	220	1/4W	5%	RMC1/4 221JATP	J24245221		1-	B	e2
R 1664	CHIP RES.	220	1/2W	5%	RMC1/2 221JCTP	J24275221		1-	B	e3
R 1665	CHIP RES.	470	1/2W	5%	RMC1/2 471JCTP	J24275471		1-	B	d1
R 1666	METAL FILM RES.	470	3W	5%	ERG-3SJ471 470	J22359009		1-	B	e2
R 1667	CHIP RES.	8.2k	1/16W	5%	RMC1/16S 822JTH	J24189036		1-	B	e3
R 1668	CHIP RES.	47	1/16W	5%	RMC1/16S 470JTH	J24189009		1-	B	e3
R 1669	CHIP RES.	12k	1/16W	5%	RMC1/16S 123JTH	J24189038		1-	B	d3
R 1670	CHIP RES.	47	1/16W	5%	RMC1/16S 470JTH	J24189009		1-	B	e3
R 1671	CHIP RES.	100	1/16W	5%	RMC1/16S 101JTH	J24189013		1-	A	D3
R 1672	CHIP RES.	82	1/16W	5%	RMC1/16S 820JTH	J24189012		1-	B	d3
R 1673	CHIP RES.	47	1/16W	5%	RMC1/16S 470JTH	J24189009		1-	B	c3
R 1674	CHIP RES.	330	1/16W	5%	RMC1/16S 331JTH	J24189019		1-	B	d3
R 1675	CHIP RES.	47	1/16W	5%	RMC1/16S 470JTH	J24189009		1-	B	c3
R 1676	CHIP RES.	330	1/16W	5%	RMC1/16S 331JTH	J24189019		1-	B	d3
R 1677	CHIP RES.	47	1/16W	5%	RMC1/16S 470JTH	J24189009		1-	B	d3
R 1678	CHIP RES.	150	1/16W	5%	RMC1/16S 151JTH	J24189015		1-	B	d3
R 1679	CHIP RES.	47	1/16W	5%	RMC1/16S 470JTH	J24189009		1-	B	d3
R 1680	CHIP RES.	100	1/16W	5%	RMC1/16S 101JTH	J24189013		1-	B	d3
R 1681	CHIP RES.	4.7k	1/16W	5%	RMC1/16S 472JTH	J24189033		1-	B	d3
R 1682	CHIP RES.	220	1/16W	5%	RMC1/16S 221JTH	J24189017		1-	A	D3
R 1683	CHIP RES.	220	1/16W	5%	RMC1/16S 221JTH	J24189017		1-	A	D3
R 1684	CHIP RES.	27k	1/16W	5%	RMC1/16S 273JTH	J24189042		1-	B	e3
R 1685	CHIP RES.	220	1/16W	5%	RMC1/16S 221JTH	J24189017		1-	B	d3
R 1686	CHIP RES.	22k	1/16W	5%	RMC1/16S 223JTH	J24189041		1-	B	e3
R 1687	CHIP RES.	100	1/16W	5%	RMC1/16S 101JTH	J24189013		1-	A	C3
R 1688	CHIP RES.	1k	1/16W	5%	RMC1/16S 102JTH	J24189025		1-	A	C3
R 1689	CHIP RES.	470	1/16W	5%	RMC1/16S 471JTH	J24189021		1-	A	C3
R 1690	CHIP RES.	470	1/16W	5%	RMC1/16S 471JTH	J24189021		1-	A	C3
R 1691	CHIP RES.	1k	1/16W	5%	RMC1/16S 102JTH	J24189025		1-	A	D3
R 1692	CHIP RES.	2.2k	1/16W	5%	RMC1/16S 222JTH	J24189029		1-	B	d3
R 1693	CHIP RES.	1k	1/16W	5%	RMC1/16S 102JTH	J24189025		1-	B	d3
R 1694	CHIP RES.	1k	1/16W	5%	RMC1/16S 102JTH	J24189025		1-	B	d3
R 1695	CHIP RES.	1k	1/16W	5%	RMC1/16S 102JTH	J24189025		1-	A	C2
R 1696	CHIP RES.	4.7k	1/16W	5%	RMC1/16S 472JTH	J24189033		1-	A	G3
R 1697	CHIP RES.	4.7k	1/16W	5%	RMC1/16S 472JTH	J24189033		1-	B	a4
R 1698	CHIP RES.	4.7k	1/16W	5%	RMC1/16S 472JTH	J24189033		1-	A	G4
R 1699	CHIP RES.	220	1/16W	5%	RMC1/16S 221JTH	J24189017		1-	A	B1
R 1700	CHIP RES.	220	1/16W	5%	RMC1/16S 221JTH	J24189017		1-	A	B1
R 1701	CHIP RES.	82	1/16W	5%	RMC1/16S 820JTH	J24189012		1-	B	e1
R 1702	CHIP RES.	82	1/16W	5%	RMC1/16S 820JTH	J24189012		1-	B	d3
R 1703	CHIP RES.	10k	1/16W	5%	RMC1/16S 103JTH	J24189037		1-	B	d3
R 1704	CHIP RES.	150	1/16W	5%	RMC1/16S 151JTH	J24189015		1-	A	D4
R 1705	CHIP RES.	100	1/16W	5%	RMC1/16S 101JTH	J24189013		1-	B	e5
R 1706	CHIP RES.	100k	1/16W	5%	RMC1/16S 104JTH	J24189049		1-	B	e5
R 1707	CHIP RES.	4.7k	1/16W	5%	RMC1/16S 472JTH	J24189033		1-	B	e5
R 1708	CHIP RES.	1k	1/16W	5%	RMC1/16S 102JTH	J24189025		1-	B	e5
R 1709	CHIP RES.	1k	1/16W	5%	RMC1/16S 102JTH	J24189025		1-	B	d5
R 1710	CHIP RES.	4.7k	1/16W	5%	RMC1/16S 472JTH	J24189033		1-	B	d5

MAIN Unit

Parts List

REF	DESCRIPTION	VALUE	V/W	TOL.	MFR'S DESIG	VXSTD P/N	VERS.	LOT	SIDE	LAY ADR
R 1711	CHIP RES.	470	1/16W	5%	RMC1/16S 471JTH	J24189021		1-	A	E5
R 1712	CHIP RES.	68k	1/16W	5%	RMC1/16S 683JTH	J24189047		1-	A	C4
R 1713	CHIP RES.	22k	1/16W	5%	RMC1/16S 223JTH	J24189041		1-	A	A2
R 1714	CHIP RES.	47k	1/16W	5%	RMC1/16S 473JTH	J24189045		1-	A	A1
R 1715	CHIP RES.	10k	1/16W	5%	RMC1/16S 103JTH	J24189037		1-	B	d3
R 1716	CHIP RES.	10k	1/16W	5%	RMC1/16S 103JTH	J24189037		1-	B	d3
R 1717	CHIP RES.	15k	1/16W	5%	RMC1/16S 153JTH	J24189039		1-	A	D4
R 1718	CHIP RES.	10k	1/16W	5%	RMC1/16S 103JTH	J24189037		1-	A	C4
R 1719	CHIP RES.	100k	1/16W	0.5%	RR0510R-104-D	J24189167		1-	B	c4
R 1720	CHIP RES.	47k	1/16W	5%	RMC1/16S 473JTH	J24189045		1-	B	f4
R 1721	CHIP RES.	3.3k	1/16W	0.5%	RR0510P-332-D	J24189131		1-	B	d5
R 1722	CHIP RES.	100k	1/16W	5%	RMC1/16S 104JTH	J24189049		1-	B	d5
R 1723	CHIP RES.	33k	1/16W	5%	RMC1/16S 333JTH	J24189043		1-	A	C4
R 1725	CHIP RES.	1k	1/16W	5%	RMC1/16S 102JTH	J24189025		1-	B	d3
R 1726	CHIP RES.	100	1/16W	5%	RMC1/16S 101JTH	J24189013		1-	B	e3
R 1727	CHIP RES.	220	1/16W	5%	RMC1/16S 221JTH	J24189017		1-	B	b2
R 1728	CHIP RES.	220	1/16W	5%	RMC1/16S 221JTH	J24189017		1-	B	b2
R 1729	CHIP RES.	10k	1/16W	5%	RMC1/16S 103JTH	J24189037		1-	B	c3
R 1730	CHIP RES.	1k	1/16W	5%	RMC1/16S 102JTH	J24189025		1-	B	e5
R 1731	CHIP RES.	1k	1/16W	5%	RMC1/16S 102JTH	J24189025		1-	B	f2
R 1732	CHIP RES.	100k	1/16W	5%	RMC1/16S 104JTH	J24189049		1-	A	A4
R 1733	CHIP RES.	100	1/16W	5%	RMC1/16S 101JTH	J24189013		1-	B	c3
R 1734	CHIP RES.	1k	1/16W	5%	RMC1/16S 102JTH	J24189025		1-	A	D3
R 1736	CHIP RES.	10	1/16W	5%	RMC1/16S 100JTH	J24189001		1-	A	B2
R 1737	CHIP RES.	10	1/16W	5%	RMC1/16S 100JTH	J24189001		1-	A	B2
R 1738	CHIP RES.	10	1/16W	5%	RMC1/16S 100JTH	J24189001		1-	A	B2
R 1739	CHIP RES.	4.7k	1/16W	5%	RMC1/16S 472JTH	J24189033		1-	A	E5
R 1740	CHIP RES.	15k	1/16W	5%	RMC1/16S 153JTH	J24189039		1-	A	E5
R 1745	CHIP RES.	470k	1/16W	5%	RMC1/16S 474JTH	J24189057		1-		
R 1747	CHIP RES.	100	1/16W	5%	RMC1/16 101JATP	J24185101		1-		
RL1001	RELAY		DC12V		G5A-237P DC12V	M1190067		1-	A	F1
RL1002	RELAY		DC12V		G5A-237P DC12V	M1190067		1-	A	E3
RL1003	RELAY		DC12V		G5A-237P DC12V	M1190067		1-	A	F4
TH1001	THERMISTOR				TBPS1R103K440H5Q	G9090067		1-	A	C3
TH1002	THERMISTOR				TBPS1R103K440H5Q	G9090067		1-	B	d4
TH1003	THERMISTOR				TBPS1R473K475H5Q	G9090068		1-	B	d4
TH1004	THERMISTOR				TBPS1R473K475H5Q	G9090068		1-	B	d5
TH1005	THERMISTOR				TBPS1R103K440H5Q	G9090067		1-	B	d5
X 1001	XTAL CSA-310	3.6864MHZ			3.6864MHZ	H0102988		1-	A	A4
X 1002	XTAL TSS-6	11.7MHZ			TSS-5032A 11.7MHZ	H0103264		1-	B	e4
X 1003	XTAL TSS-5032A	11.15MHZ			11.15MHZ	H0103268		1-	B	c5
XF1001	XTAL FILTER				MFT47R 47.25MHZ	H1102352		1-	A	C4
XF1002	XTAL FILTER				MFT45R6 45.05MHZ	H1102351		1-	B	b5
	GROUND PLATE SHIELD CASE VCO					RA0415200 RA0272500		1- 1-		

Downloaded by
RadioAmateur.EU

MAIN Unit

Parts List

PANEL Unit

Circuit Diagram

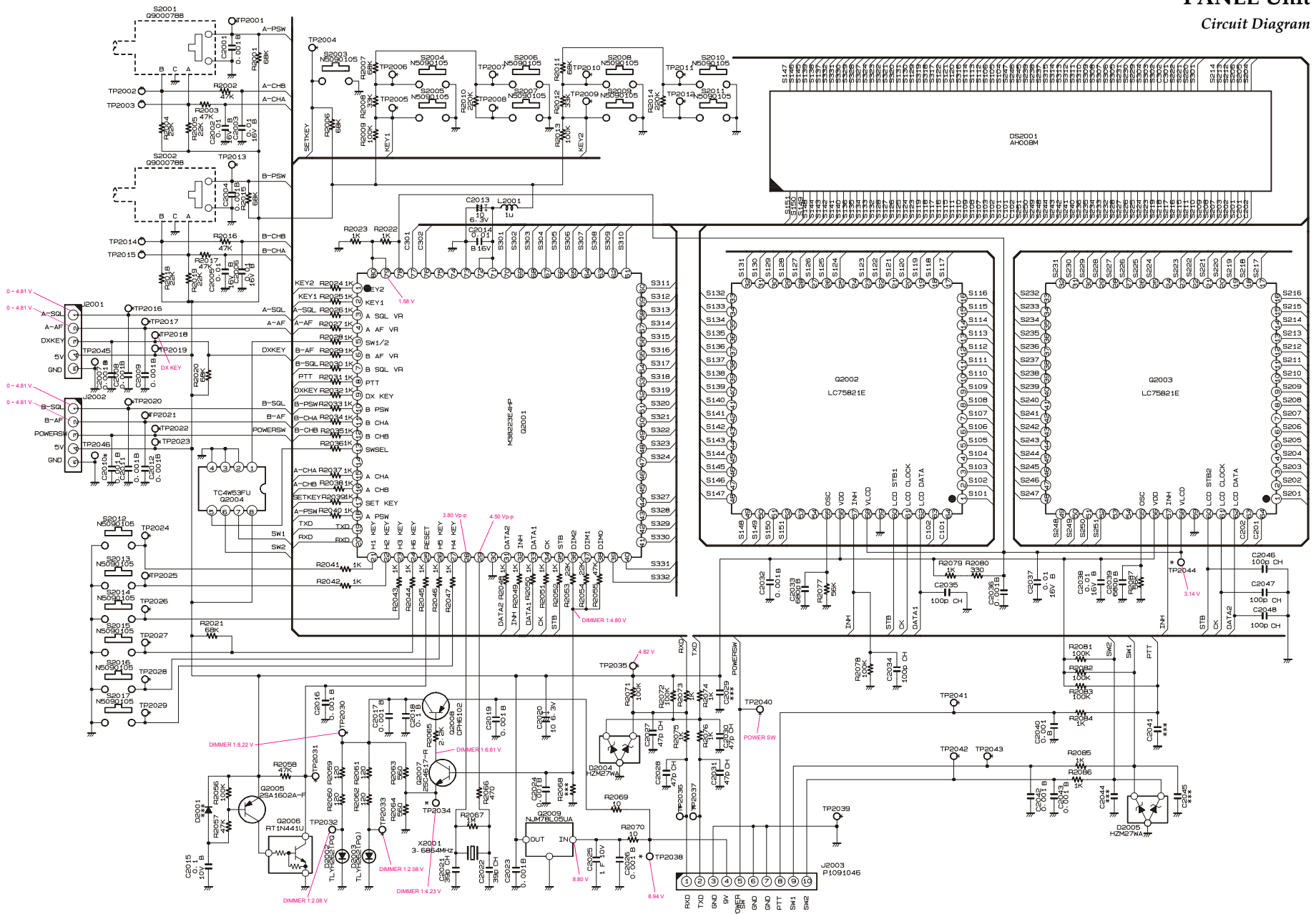

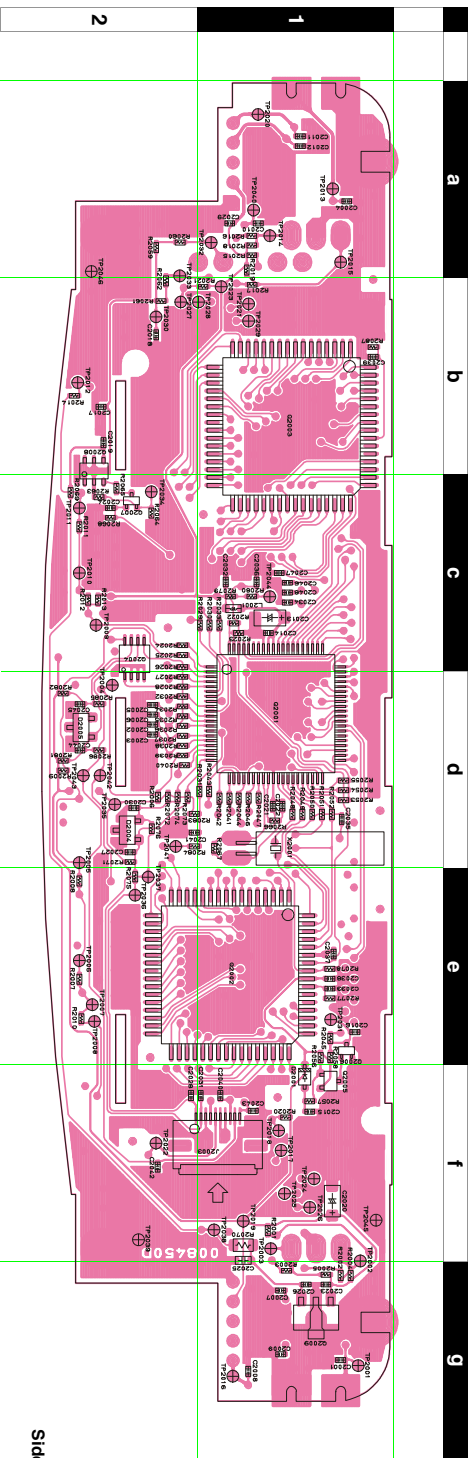
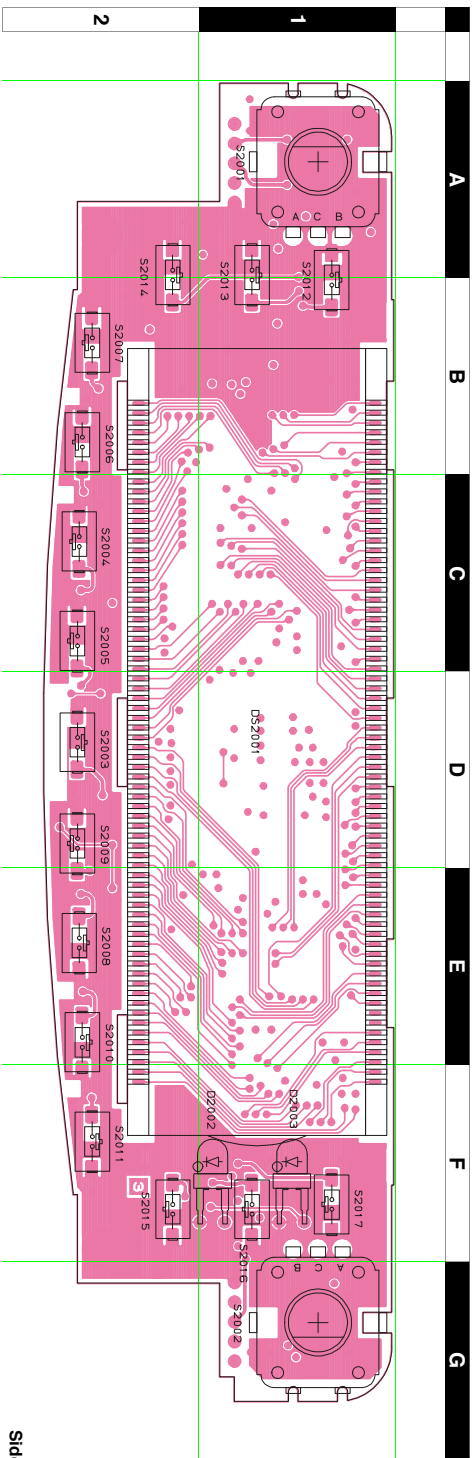

PANEL Unit

Circuit Diagram





Downloaded by
RadioAmateur.EU

- 

MS823E4HP (Q2001)
- 

LC75821E (Q2002, 2003)
- 

TC4W5FHU (Q2004)
- 

CPH6102 (Q2004)
- 

2SA1602A (MF) (Q2005)
- 

2SC4617 (BR) (Q2007)
- 

RT1N441U (N3) (Q2006)
- 

NJM78L05 (8C) (Q2009)
- 

H2M27VA (N3) (D2004, 2005)

PANEL Unit

Parts List

REF	DESCRIPTION	VALUE	V/W	TOL.	MFR'S DESIG	VXSTD P/N	VERS.	LOT	SIDE	LAY ADR
PCB with Components						CB2131001				
Printed Circuit Board						AH008M000	FR0084500			
C 2001	CHIP CAP.	0.001uF	50V	B	GRM36B102K50PT	K22178809		1-	B	g1
C 2002	CHIP CAP.	0.022uF	16V	B	GRM36B223K16PT	K22128806		1-	B	d2
C 2003	CHIP CAP.	0.022uF	16V	B	GRM36B223K16PT	K22128806		1-	B	d2
C 2004	CHIP CAP.	0.001uF	50V	B	GRM36B102K50PT	K22178809		1-	B	a1
C 2005	CHIP CAP.	0.022uF	16V	B	GRM36B223K16PT	K22128806		1-	B	d2
C 2006	CHIP CAP.	0.022uF	16V	B	GRM36B223K16PT	K22128806		1-	B	d2
C 2007	CHIP CAP.	0.001uF	50V	B	GRM36B102K50PT	K22178809		1-	B	g1
C 2008	CHIP CAP.	0.001uF	50V	B	GRM36B102K50PT	K22178809		1-	B	g1
C 2009	CHIP CAP.	0.001uF	50V	B	GRM36B102K50PT	K22178809		1-	B	g1
C 2010	CHIP CAP.	0.001uF	50V	B	GRM36B102K50PT	K22178809		1-	B	a1
C 2011	CHIP CAP.	0.001uF	50V	B	GRM36B102K50PT	K22178809		1-	B	a1
C 2012	CHIP CAP.	0.001uF	50V	B	GRM36B102K50PT	K22178809		1-	B	a1
C 2013	CHIP TA.CAP.	10uF	6.3V		TEMSVA0J106M-8R	K78080027		1-	B	c1
C 2014	CHIP CAP.	0.01uF	16V	B	GRM36B103K16PT	K22128804		1-	B	c1
C 2015	CHIP CAP.	0.1uF	10V	B	GRM36B104K10PT	K22108802		1-	B	f1
C 2016	CHIP CAP.	0.001uF	50V	B	GRM36B102K50PT	K22178809		1-	B	e1
C 2017	CHIP CAP.	0.001uF	50V	B	GRM36B102K50PT	K22178809		1-	B	b2
C 2018	CHIP CAP.	0.1uF	10V	B	GRM36B104K10PT	K22108802		1-	B	b2
C 2019	CHIP CAP.	0.001uF	50V	B	GRM36B102K50PT	K22178809		1-	B	b2
C 2020	CHIP TA.CAP.	10uF	6.3V		TEMSVA0J106M-8R	K78080027		1-	B	f1
C 2021	CHIP CAP.	39pF	50V	CH	GRM36CH390J50PT	K22178226		1-	B	d1
C 2022	CHIP CAP.	39pF	50V	CH	GRM36CH390J50PT	K22178226		1-	B	d1
C 2023	CHIP CAP.	0.001uF	50V	B	GRM36B102K50PT	K22178809		1-	B	g1
C 2024	CHIP CAP.	0.001uF	50V	B	GRM36B102K50PT	K22178809		1-	B	c2
C 2025	CHIP CAP.	1uF	10V	F	GRM39F105Z10PT	K22105001		1-	B	f1
C 2026	CHIP CAP.	0.001uF	50V	B	GRM36B102K50PT	K22178809		1-	B	g1
C 2027	CHIP CAP.	47pF	50V	CH	GRM36CH470J50PT	K22178228		1-	B	d2
C 2028	CHIP CAP.	47pF	50V	CH	GRM36CH470J50PT	K22178228		1-	B	f2
C 2030	CHIP CAP.	47pF	50V	CH	GRM36CH470J50PT	K22178228		1-	B	d2
C 2031	CHIP CAP.	47pF	50V	CH	GRM36CH470J50PT	K22178228		1-	B	f1
C 2032	CHIP CAP.	0.001uF	50V	B	GRM36B102K50PT	K22178809		1-	B	c1
C 2033	CHIP CAP.	680pF	50V	B	GRM36B681K50PT	K22178807		1-	B	e1
C 2034	CHIP CAP.	100pF	50V	CH	GRM36CH101J50PT	K22178236		1-	B	c1
C 2035	CHIP CAP.	100pF	50V	CH	GRM36CH101J50PT	K22178236		1-	B	d1
C 2036	CHIP CAP.	0.001uF	50V	B	GRM36B102K50PT	K22178809		1-	B	c1
C 2037	CHIP CAP.	0.01uF	16V	B	GRM36B103K16PT	K22128804		1-	B	e1
C 2038	CHIP CAP.	0.01uF	16V	B	GRM36B103K16PT	K22128804		1-	B	e1
C 2039	CHIP CAP.	680pF	50V	B	GRM36B681K50PT	K22178807		1-	B	b1
C 2040	CHIP CAP.	0.001uF	50V	B	GRM36B102K50PT	K22178809		1-	B	f1
C 2042	CHIP CAP.	0.001uF	50V	B	GRM36B102K50PT	K22178809		1-	B	f2
C 2043	CHIP CAP.	0.001uF	50V	B	GRM36B102K50PT	K22178809		1-	B	f1
C 2046	CHIP CAP.	100pF	50V	CH	GRM36CH101J50PT	K22178236		1-	B	c1
C 2047	CHIP CAP.	100pF	50V	CH	GRM36CH101J50PT	K22178236		1-	B	c1
C 2048	CHIP CAP.	100pF	50V	CH	GRM36CH101J50PT	K22178236		1-	B	c1
D 2002	LED				TLYH262(PQ)	G2090777		1-	A	F1
D 2003	LED				TLYH262(PQ)	G2090777		1-	A	F1
D 2004	DIODE				HZM27WA-TR	G2070530		1-	B	d2
D 2005	DIODE				HZM27WA-TR	G2070530		1-	B	d2
D 2006	DIODE				UDZS TE-17 6.8B	G2070888		1-		
DS2001	LCD				AH008M	G6090147		1-	A	D1
J 2003	CONNECTOR				IL-FHR-10S-HF-E3000	P1091046		1-	B	f1
L 2001	M.RFC	1uH			LK1608 1R0K-T	L1690687		1-	B	c1
Q 2001	IC				M38223E4HP R0660	G1093477		1	B	d1
Q 2002	IC				LC75821E	G1092191		1-	B	e1
Q 2003	IC				LC75821E	G1092191		1-	B	b1
Q 2004	IC				TC4W53FU TE12L	G1091675		1-	B	c2
Q 2005	TRANSISTOR				2SA1602A-T11-1F	G3116028F		1-	B	f1
Q 2006	TRANSISTOR				RT1N441U-T11-1	G3070247		1-	B	e1
Q 2007	TRANSISTOR				2SC4617 TL R	G3346178R		1-	B	c2
Q 2008	TRANSISTOR				CPH6102-TL	G3070223		1-	B	b2
Q 2009	IC				NJM78L05UA TE1	G1091325		1-	B	g1
R 2001	CHIP RES.	68k	1/16W	5%	RMC1/16S 683JTH	J24189047		1-	B	f1
R 2002	CHIP RES.	47k	1/16W	5%	RMC1/16S 473JTH	J24189045		1-	B	g1
R 2003	CHIP RES.	47k	1/16W	5%	RMC1/16S 473JTH	J24189045		1-	B	g1
R 2004	CHIP RES.	22k	1/16W	5%	RMC1/16S 223JTH	J24189041		1-	B	g1
R 2005	CHIP RES.	22k	1/16W	5%	RMC1/16S 223JTH	J24189041		1-	B	g1
R 2006	CHIP RES.	68k	1/16W	5%	RMC1/16S 683JTH	J24189047		1-	B	d2
R 2007	CHIP RES.	68k	1/16W	5%	RMC1/16S 683JTH	J24189047		1-	B	e2
R 2008	CHIP RES.	33k	1/16W	5%	RMC1/16S 333JTH	J24189043		1-	B	e2
R 2009	CHIP RES.	100k	1/16W	5%	RMC1/16S 104JTH	J24189049		1-	B	d2
R 2010	CHIP RES.	220k	1/16W	5%	RMC1/16S 224JTH	J24189053		1-	B	e2
R 2011	CHIP RES.	68k	1/16W	5%	RMC1/16S 683JTH	J24189047		1-	B	c2
R 2012	CHIP RES.	33k	1/16W	5%	RMC1/16S 333JTH	J24189043		1-	B	c2
R 2013	CHIP RES.	100k	1/16W	5%	RMC1/16S 104JTH	J24189049		1-	B	c2

PANEL Unit

Parts List

REF	DESCRIPTION	VALUE	V/W	TOL.	MFR'S DESIG	VXSTD P/N	VERS.	LOT	SIDE	LAY ADR
R 2014	CHIP RES.	220k	1/16W	5%	RMC1/16S 224JTH	J24189053		1-	B	b2
R 2015	CHIP RES.	68k	1/16W	5%	RMC1/16S 683JTH	J24189047		1-	B	a1
R 2016	CHIP RES.	47k	1/16W	5%	RMC1/16S 473JTH	J24189045		1-	B	a1
R 2017	CHIP RES.	47k	1/16W	5%	RMC1/16S 473JTH	J24189045		1-	B	b1
R 2018	CHIP RES.	22k	1/16W	5%	RMC1/16S 223JTH	J24189041		1-	B	a1
R 2019	CHIP RES.	22k	1/16W	5%	RMC1/16S 223JTH	J24189041		1-	B	a1
R 2020	CHIP RES.	68k	1/16W	5%	RMC1/16S 683JTH	J24189047		1-	B	f1
R 2021	CHIP RES.	68k	1/16W	5%	RMC1/16S 683JTH	J24189047		1-	B	b1
R 2022	CHIP RES.	1k	1/16W	5%	RMC1/16S 102JTH	J24189025		1-	B	c1
R 2023	CHIP RES.	1k	1/16W	5%	RMC1/16S 102JTH	J24189025		1-	B	c1
R 2024	CHIP RES.	1k	1/16W	5%	RMC1/16S 102JTH	J24189025		1-	B	c2
R 2025	CHIP RES.	1k	1/16W	5%	RMC1/16S 102JTH	J24189025		1-	B	c2
R 2026	CHIP RES.	1k	1/16W	5%	RMC1/16S 102JTH	J24189025		1-	B	c2
R 2027	CHIP RES.	1k	1/16W	5%	RMC1/16S 102JTH	J24189025		1-	B	d2
R 2028	CHIP RES.	1k	1/16W	5%	RMC1/16S 102JTH	J24189025		1-	B	d2
R 2029	CHIP RES.	1k	1/16W	5%	RMC1/16S 102JTH	J24189025		1-	B	c1
R 2030	CHIP RES.	1k	1/16W	5%	RMC1/16S 102JTH	J24189025		1-	B	c1
R 2031	CHIP RES.	1k	1/16W	5%	RMC1/16S 102JTH	J24189025		1-	B	d1
R 2032	CHIP RES.	1k	1/16W	5%	RMC1/16S 102JTH	J24189025		1-	B	d2
R 2033	CHIP RES.	1k	1/16W	5%	RMC1/16S 102JTH	J24189025		1-	B	c1
R 2034	CHIP RES.	1k	1/16W	5%	RMC1/16S 102JTH	J24189025		1-	B	d2
R 2035	CHIP RES.	1k	1/16W	5%	RMC1/16S 102JTH	J24189025		1-	B	d2
R 2036	CHIP RES.	1k	1/16W	5%	RMC1/16S 102JTH	J24189025		1-	B	d2
R 2037	CHIP RES.	1k	1/16W	5%	RMC1/16S 102JTH	J24189025		1-	B	d2
R 2038	CHIP RES.	1k	1/16W	5%	RMC1/16S 102JTH	J24189025		1-	B	d2
R 2039	CHIP RES.	1k	1/16W	5%	RMC1/16S 102JTH	J24189025		1-	B	d2
R 2040	CHIP RES.	1k	1/16W	5%	RMC1/16S 102JTH	J24189025		1-	B	d2
R 2041	CHIP RES.	1k	1/16W	5%	RMC1/16S 102JTH	J24189025		1-	B	d2
R 2042	CHIP RES.	1k	1/16W	5%	RMC1/16S 102JTH	J24189025		1-	B	d1
R 2043	CHIP RES.	1k	1/16W	5%	RMC1/16S 102JTH	J24189025		1-	B	d1
R 2044	CHIP RES.	1k	1/16W	5%	RMC1/16S 102JTH	J24189025		1-	B	d1
R 2045	CHIP RES.	1k	1/16W	5%	RMC1/16S 102JTH	J24189025		1-	B	e1
R 2046	CHIP RES.	1k	1/16W	5%	RMC1/16S 102JTH	J24189025		1-	B	d1
R 2047	CHIP RES.	1k	1/16W	5%	RMC1/16S 102JTH	J24189025		1-	B	d1
R 2048	CHIP RES.	1k	1/16W	5%	RMC1/16S 102JTH	J24189025		1-	B	d1
R 2049	CHIP RES.	1k	1/16W	5%	RMC1/16S 102JTH	J24189025		1-	B	d1
R 2050	CHIP RES.	1k	1/16W	5%	RMC1/16S 102JTH	J24189025		1-	B	d1
R 2051	CHIP RES.	1k	1/16W	5%	RMC1/16S 102JTH	J24189025		1-	B	d1
R 2052	CHIP RES.	1k	1/16W	5%	RMC1/16S 102JTH	J24189025		1-	B	d1
R 2053	CHIP RES.	22k	1/16W	5%	RMC1/16S 223JTH	J24189041		1-	B	d1
R 2054	CHIP RES.	22k	1/16W	5%	RMC1/16S 223JTH	J24189041		1-	B	d1
R 2055	CHIP RES.	47k	1/16W	5%	RMC1/16S 473JTH	J24189045		1-	B	d1
R 2056	CHIP RES.	100k	1/16W	5%	RMC1/16S 104JTH	J24189049		1-	B	e1
R 2057	CHIP RES.	47k	1/16W	5%	RMC1/16S 473JTH	J24189045		1-	B	f1
R 2058	CHIP RES.	47k	1/16W	5%	RMC1/16S 473JTH	J24189045		1-	B	e1
R 2059	CHIP RES.	120	1/16W	5%	RMC1/16S 121JTH	J24189014		1-	B	a2
R 2060	CHIP RES.	120	1/16W	5%	RMC1/16S 121JTH	J24189014		1-	B	a2
R 2061	CHIP RES.	120	1/16W	5%	RMC1/16S 121JTH	J24189014		1-	B	b2
R 2062	CHIP RES.	120	1/16W	5%	RMC1/16S 121JTH	J24189014		1-	B	b2
R 2063	CHIP RES.	560	1/16W	5%	RMC1/16S 561JTH	J24189022		1-	B	c2
R 2064	CHIP RES.	560	1/16W	5%	RMC1/16S 561JTH	J24189022		1-	B	c2
R 2065	CHIP RES.	2.2k	1/16W	5%	RMC1/16S 222JTH	J24189029		1-	B	c2
R 2066	CHIP RES.	470	1/16W	5%	RMC1/16S 471JTH	J24189021		1-	B	d1
R 2067	CHIP RES.	1M	1/16W	5%	RMC1/16S 105JTH	J24189061		1-	B	d1
R 2069	CHIP RES.	10	1/16W	5%	RMC1/16S 100JTH	J24189001		1-	B	c2
R 2070	CHIP RES.	10	1/10W	5%	RMC1/10T 100J	J24205100		1-	B	f1
R 2071	CHIP RES.	100k	1/16W	5%	RMC1/16S 104JTH	J24189049		1-	B	d2
R 2072	CHIP RES.	100k	1/16W	5%	RMC1/16S 104JTH	J24189049		1-	B	d2
R 2073	CHIP RES.	1k	1/16W	5%	RMC1/16S 102JTH	J24189025		1-	B	d2
R 2074	CHIP RES.	1k	1/16W	5%	RMC1/16S 102JTH	J24189025		1-	B	d2
R 2075	CHIP RES.	1k	1/16W	5%	RMC1/16S 102JTH	J24189025		1-	B	e2
R 2076	CHIP RES.	1k	1/16W	5%	RMC1/16S 102JTH	J24189025		1-	B	d2
R 2077	CHIP RES.	56k	1/16W	5%	RMC1/16S 563JTH	J24189046		1-	B	e1
R 2078	CHIP RES.	100k	1/16W	5%	RMC1/16S 104JTH	J24189049		1-	B	e1
R 2079	CHIP RES.	1k	1/16W	5%	RMC1/16S 102JTH	J24189025		1-	B	c1
R 2080	CHIP RES.	330	1/16W	5%	RMC1/16S 331JTH	J24189019		1-	B	c1
R 2081	CHIP RES.	100k	1/16W	5%	RMC1/16S 104JTH	J24189049		1-	B	d2
R 2082	CHIP RES.	100k	1/16W	5%	RMC1/16S 104JTH	J24189049		1-	B	d2
R 2083	CHIP RES.	100k	1/16W	5%	RMC1/16S 104JTH	J24189049		1-	B	d2
R 2084	CHIP RES.	1k	1/16W	5%	RMC1/16S 102JTH	J24189025		1-	B	d2
R 2085	CHIP RES.	1k	1/16W	5%	RMC1/16S 102JTH	J24189025		1-	B	d2
R 2086	CHIP RES.	1k	1/16W	5%	RMC1/16S 102JTH	J24189025		1-	B	d2
R 2087	CHIP RES.	56k	1/16W	5%	RMC1/16S 563JTH	J24189046		1-	B	b1
S 2001	ROTARY ENCODER				EC12E2424404	Q9000788		1-	A	A1
S 2002	ROTARY ENCODER				EC12E2424404	Q9000788		1-	A	G1
S 2003	TACT SWITCH				SKQMAL	N5090105		1-	A	D2

PANEL Unit

Parts List

REF	DESCRIPTION	VALUE	V/W	TOL.	MFR'S DESIG	VXSTD P/N	VERS.	LOT	SIDE	LAY ADR
S 2004	TACT SWITCH				SKQMAL	N5090105		1-	A	C2
S 2005	TACT SWITCH				SKQMAL	N5090105		1-	A	C2
S 2006	TACT SWITCH				SKQMAL	N5090105		1-	A	B2
S 2007	TACT SWITCH				SKQMAL	N5090105		1-	A	B2
S 2008	TACT SWITCH				SKQMAL	N5090105		1-	A	E2
S 2009	TACT SWITCH				SKQMAL	N5090105		1-	A	D2
S 2010	TACT SWITCH				SKQMAL	N5090105		1-	A	E2
S 2011	TACT SWITCH				SKQMAL	N5090105		1-	A	F2
S 2012	TACT SWITCH				SKQMAL	N5090105		1-	A	B1
S 2013	TACT SWITCH				SKQMAL	N5090105		1-	A	A1
S 2014	TACT SWITCH				SKQMAL	N5090105		1-	A	A2
S 2015	TACT SWITCH				SKQMAL	N5090105		1-	A	F2
S 2016	TACT SWITCH				SKQMAL	N5090105		1-	A	F1
S 2017	TACT SWITCH				SKQMAL	N5090105		1-	A	F1
X 2001	XTAL CSA-310	3.6864MHz			3.6864MHZ	H0102988		1-	B	d1

Downloaded by
RadioAmateur.EU

PANEL Unit

Note

PANEL-SUB Unit

Circuit Diagram

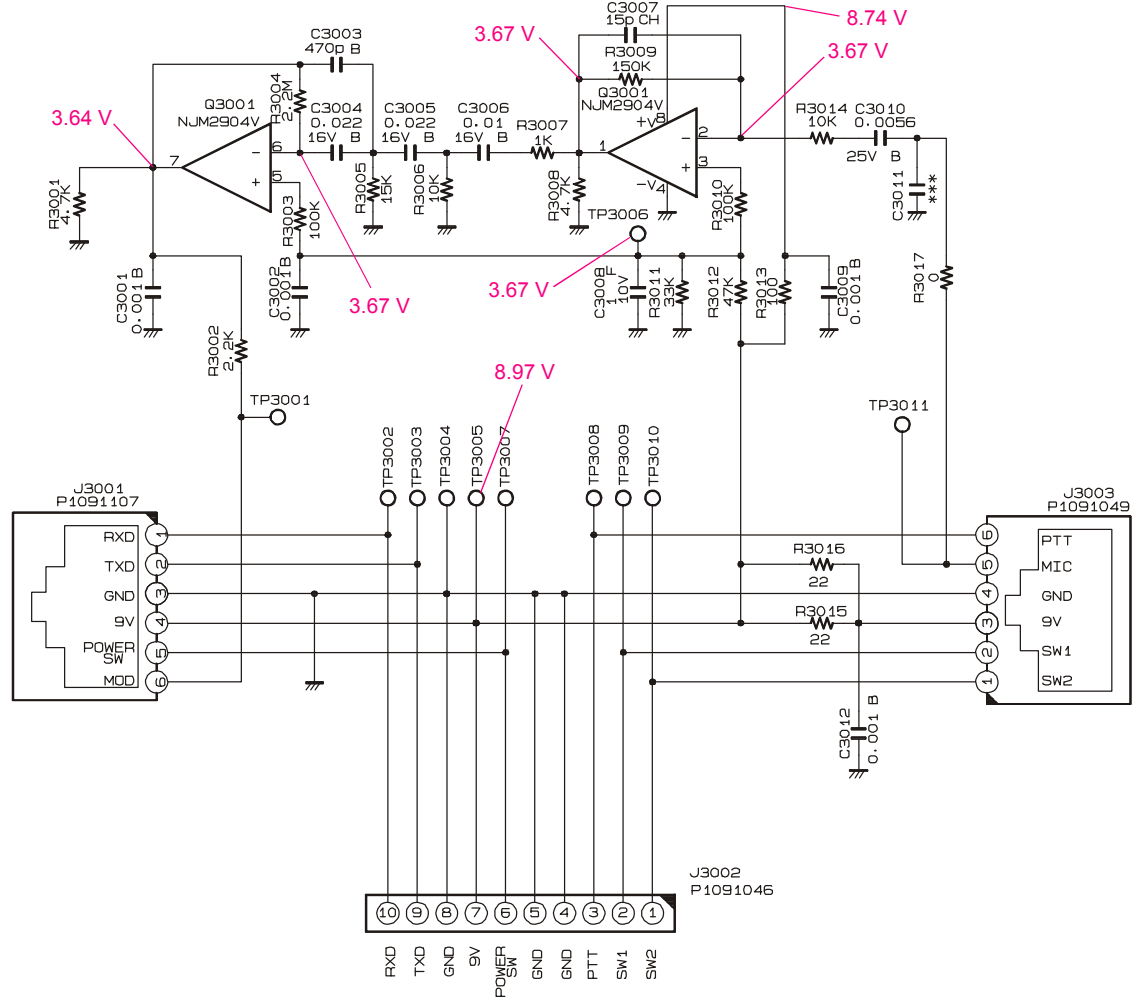

PANEL-SUB Unit

Parts Layout

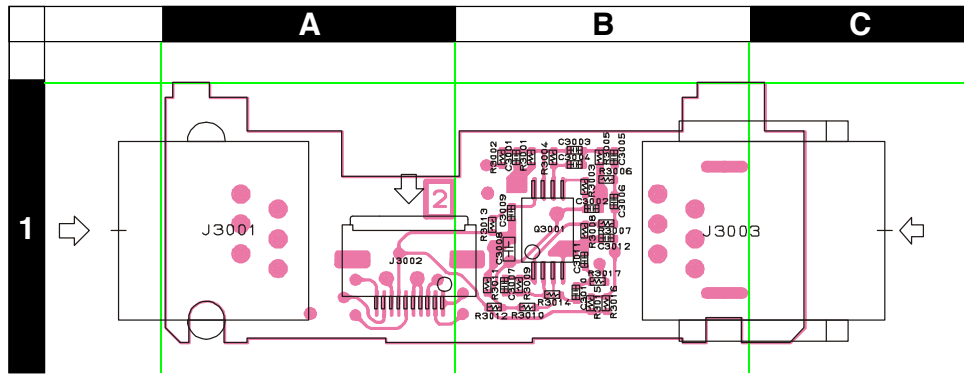

Side A

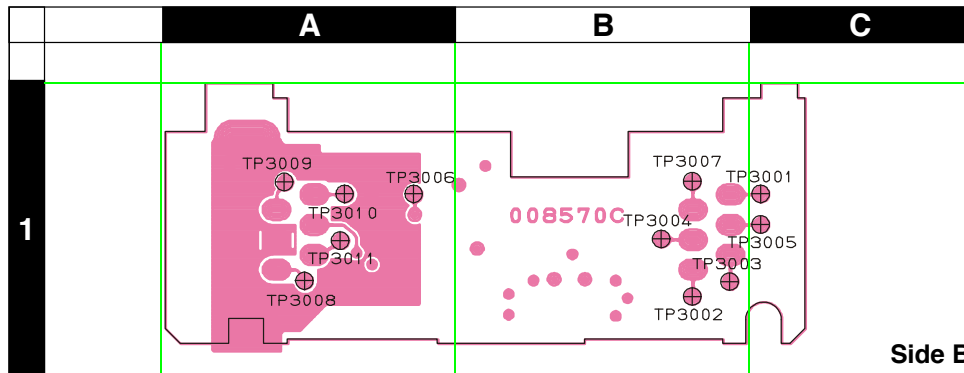

Side B

Parts List

REF	DESCRIPTION	VALUE	V/W	TOL.	MFR'S DESIG	VXSTD P/N	VERS.	LOT	SIDE	LAY ADR
PCB with Components						CB2132003	DST: USA			
						CB2132004	DST: EXP			
						CB2132005	DST: FRG			
Printed Circuit Board					AH008M000	FR0085700		1-		
C 3001	CHIP CAP.	0.001uF	50V	B	GRM36B102K50PT	K22178809		1-	A	B1
C 3002	CHIP CAP.	0.001uF	50V	B	GRM36B102K50PT	K22178809		1-	A	B1
C 3003	CHIP CAP.	470pF	50V	B	GRM36B471K50PT	K22178805		1-	A	B1
C 3004	CHIP CAP.	0.022uF	16V	B	GRM36B223K16PT	K22128806		1-	A	B1
C 3005	CHIP CAP.	0.022uF	16V	B	GRM36B223K16PT	K22128806		1-	A	B1
C 3006	CHIP CAP.	0.01uF	16V	B	GRM36B103K16PT	K22128804		1-	A	B1
C 3007	CHIP CAP.	15pF	50V	CH	GRM36CH150J50PT	K22178216		1-	A	B1
C 3008	CHIP CAP.	1uF	10V	F	GRM39F105Z10PT	K22105001		1-	A	B1
C 3009	CHIP CAP.	0.001uF	50V	B	GRM36B102K50PT	K22178809		1-	A	B1
C 3010	CHIP CAP.	0.0056uF	25V	B	GRM36B562K50PT	K22148802		1-	A	B1
C 3012	CHIP CAP.	0.001uF	50V	B	GRM36B102K50PT	K22178809		1-	A	B1
J 3001	CONNECTOR				NTC-623PCBL6-B	P1091107		1-	A	A1
J 3002	CONNECTOR				IL-FHR-10S-HF-E3000	P1091046		1-	A	A1
J 3003	CONNECTOR				MJ-66J-RD315K	P1091049		1-	A	C1
Q 3001	IC				NJM2904V-TE1	G1091677		1-	A	B1
R 3001	CHIP RES.	4.7k	1/16W	5%	RMC1/16S 472JTH	J24189033		1-	A	B1
R 3002	CHIP RES.	2.2k	1/16W	5%	RMC1/16S 222JTH	J24189029		1-	A	B1
R 3003	CHIP RES.	100k	1/16W	5%	RMC1/16S 104JTH	J24189049		1-	A	B1
R 3004	CHIP RES.	2.2M	1/16W	5%	RMC1/16S 225JTH	J24189065		1-	A	B1
R 3005	CHIP RES.	15k	1/16W	5%	RMC1/16S 153JTH	J24189039		1-	A	B1
R 3006	CHIP RES.	10k	1/16W	5%	RMC1/16S 103JTH	J24189037		1-	A	B1
R 3007	CHIP RES.	1k	1/16W	5%	RMC1/16S 102JTH	J24189025		1-	A	B1
R 3008	CHIP RES.	4.7k	1/16W	5%	RMC1/16S 472JTH	J24189033		1-	A	B1
R 3009	CHIP RES.	150k	1/16W	5%	RMC1/16S 154JTH	J24189051		1-	A	B1
R 3010	CHIP RES.	100k	1/16W	5%	RMC1/16S 104JTH	J24189049		1-	A	B1
R 3011	CHIP RES.	33k	1/16W	5%	RMC1/16S 333JTH	J24189043		1-	A	B1
R 3012	CHIP RES.	47k	1/16W	5%	RMC1/16S 473JTH	J24189045		1-	A	B1
R 3013	CHIP RES.	100	1/16W	5%	RMC1/16S 101JTH	J24189013		1-	A	B1
R 3014	CHIP RES.	10k	1/16W	5%	RMC1/16S 103JTH	J24189037		1-	A	B1
R 3015	CHIP RES.	22	1/16W	5%	RMC1/16S 220JTH	J24189005		1-	A	B1
R 3016	CHIP RES.	22	1/16W	5%	RMC1/16S 220JTH	J24189005		1-	A	B1
R 3017	CHIP RES.	0	1/16W	5%	RMC1/16S JPTH	J24189070		1-	A	B1

Circuit Diagram

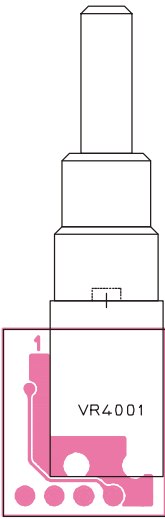
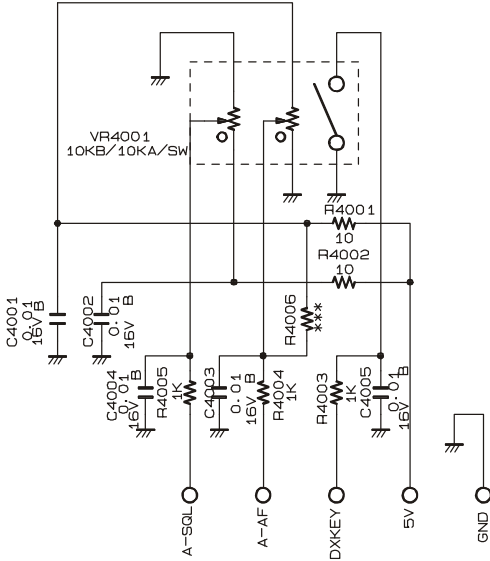

Side A

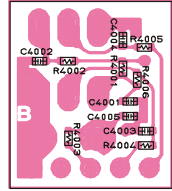

Side B

Parts List

REF	DESCRIPTION	VALUE	V/W	TOL.	MFR'S DESIG	VXSTD P/N	VERS.	LOT	SIDE	LAY ADR
PCB with Components						CB2133001				
Printed Circuit Board						AH008M000	FR0085800	1-		
C 4001	CHIP CAP.	0.01uF	16V	B	GRM36B103K16PT	K22128804		1-	B	a1
C 4002	CHIP CAP.	0.01uF	16V	B	GRM36B103K16PT	K22128804		1-	B	a1
C 4003	CHIP CAP.	0.01uF	16V	B	GRM36B103K16PT	K22128804		1-	B	a1
C 4004	CHIP CAP.	0.01uF	16V	B	GRM36B103K16PT	K22128804		1-	B	a1
C 4005	CHIP CAP.	0.01uF	16V	B	GRM36B103K16PT	K22128804		1-	B	a1
P 4000	WIRE ASSY				AH008M	T9206998		1-		
R 4001	CHIP RES.	10	1/16W	5%	RMC1/16S 100JTH	J24189001		1-	B	a1
R 4002	CHIP RES.	10	1/16W	5%	RMC1/16S 100JTH	J24189001		1-	B	a1
R 4003	CHIP RES.	1k	1/16W	5%	RMC1/16S 102JTH	J24189025		1-	B	a1
R 4004	CHIP RES.	1k	1/16W	5%	RMC1/16S 102JTH	J24189025		1-	B	a1
R 4005	CHIP RES.	1k	1/16W	5%	RMC1/16S 102JTH	J24189025		1-	B	a1
R 4006	CHIP RES.	22k	1/16W	5%	RMC1/16S 223JTH	J24189041		1	B	a1
R 4006	CHIP RES.	2.2k	1/16W	5%	RMC1/16S 222JTH	J24189029		2-	B	a1
VR4001	POT.				TP76D00A 10KB/10KB/SW	J62800140		1-	A	A1

VR-R Unit

Circuit Diagram

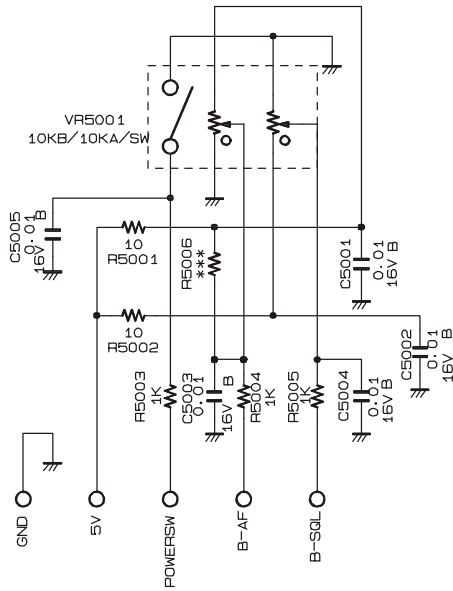

Parts Layout

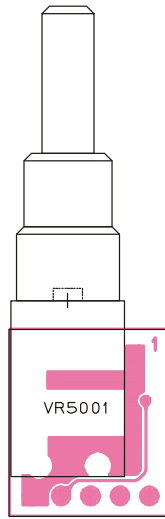

Side A

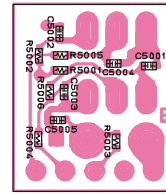

Side B

Parts List

REF	DESCRIPTION	VALUE	V/W	TOL.	MFR'S DESIG	VXSTD P/N	VERS.	LOT	SIDE	LAY ADR
PCB with Components						CB2134001				
Printed Circuit Board						AH008M000	FR0085900	1-		
C 5001	CHIP CAP.	0.01uF	16V	B	GRM36B103K16PT	K22128804		1-	B	a1
C 5002	CHIP CAP.	0.01uF	16V	B	GRM36B103K16PT	K22128804		1-	B	a1
C 5003	CHIP CAP.	0.01uF	16V	B	GRM36B103K16PT	K22128804		1-	B	a1
C 5004	CHIP CAP.	0.01uF	16V	B	GRM36B103K16PT	K22128804		1-	B	a1
C 5005	CHIP CAP.	0.01uF	16V	B	GRM36B103K16PT	K22128804		1-	B	a1
P 5000	WIRE ASSY				AH008M	T9206998		1-		
R 5001	CHIP RES.	10	1/16W	5%	RMC1/16S 100JTH	J24189001		1-	B	a1
R 5002	CHIP RES.	10	1/16W	5%	RMC1/16S 100JTH	J24189001		1-	B	a1
R 5003	CHIP RES.	1k	1/16W	5%	RMC1/16S 102JTH	J24189025		1-	B	a1
R 5004	CHIP RES.	1k	1/16W	5%	RMC1/16S 102JTH	J24189025		1-	B	a1
R 5005	CHIP RES.	1k	1/16W	5%	RMC1/16S 102JTH	J24189025		1-	B	a1
R 5006	CHIP RES.	22k	1/16W	5%	RMC1/16S 223JTH	J24189041		1-	B	a1
VR5001	POT.				TP76D00A 10KB/10KB/SW	J62800140		1-	A	A1

Downloaded by
RadioAmateur.EU



Copyright 2002
VERTEX STANDARD CO., LTD.
All rights reserved.

No portion of this manual
may be reproduced
without the permission of
VERTEX STANDARD CO., LTD.

**Downloaded by
RadioAmateur.EU**